



GOVERNMENT OF TAMILNADU

STANDARD TEN

MATHEMATICS

A publication under Free Textbook Programme of Government of Tamil Nadu

Department of School Education

**Untouchability is Inhuman and a Crime**



## Government of Tamil Nadu

First Edition - 2019

Revised Edition - 2020, 2021

(Published under new syllabus)

**NOT FOR SALE**

## Content Creation



State Council of Educational  
Research and Training

© SCERT 2019

## Printing & Publishing



Tamil Nadu Textbook and Educational  
Services Corporation

[www.textbooksonline.tn.nic.in](http://www.textbooksonline.tn.nic.in)

## SYMBOLS

$=$	equal to	$\sim$	similarly
$\neq$	not equal to	$\Delta$	symmetric difference
$<$	less than	$\mathbb{N}$	natural numbers
$\leq$	less than or equal to	$\mathbb{W}$	whole numbers
$>$	greater than	$\mathbb{Z}$	integers
$\geq$	greater than or equal to	$\mathbb{R}$	real numbers
$\approx$	equivalent to	$\triangle$	triangle
$\cup$	union	$\sphericalangle$	angle
$\cap$	intersection	$\perp$	perpendicular to
$\mathbb{U}$	universal Set	$\parallel$	parallel to
$\in$	belongs to	$\Rightarrow$	implies
$\notin$	does not belong to	$\therefore$	therefore
$\subset$	proper subset of	$\because$	since (or) because
$\subseteq$	subset of or is contained in	$  $	absolute value
$\not\subset$	not a proper subset of	$\simeq$	approximately equal to
$\not\subseteq$	not a subset of or is not contained in	$  \text{ (or) } :$	such that
$A' \text{ (or) } A^c$	complement of $A$	$\equiv \text{ (or) } \cong$	congruent
$\emptyset \text{ (or) } \{ \}$	empty set or null set or void set	$\equiv$	identically equal to
$n(A)$	number of elements in the set $A$	$\pi$	pi
$P(A)$	power set of $A$	$\pm$	plus or minus
$\Sigma$	summation		

Captions used  
in this Textbook

எண்ணென்ப ஏனை எழுத்தென்ப இவ்விரண்டும்  
கண்ணென்ப வாழும் உயிர்க்கு - குறள் 392

Numbers and letters, they are known as  
eyes to humans. - Kural 392

### Learning Outcomes

To transform the class-room processes into learning centric with a set of bench marks



### Note

Additional inputs on the content which require student to think and comprehend the concepts are given



### Thinking Corner

To kindle the inquisitiveness of students in learning mathematics. To make the students to have a diverse thinking



### Progress Check

Self evaluation of the learner's progress



### Activity

To encourage students to involve in activities to learn mathematics



### Exercise

To evaluate the learners' in understanding the content



### Multiple Choice Questions

To provide additional assessment items on the content



### Unit Exercise

Interlinking various concepts in each unit, problems are prescribed for the students to attempt and solve them



### Points to Remember

To recall the points learnt in the topic



### ICT Corner

To encourage learner's understanding of content through application of technology



Let's use the QR code in the text books!

- Download DIKSHA app from the Google Play Store.
- Tap the QR code icon to scan QR codes in the textbook.
- Point the device and focus on the QR code.
- On successful scan, content linked to the QR code gets listed.

**Note:** For ICT corner, Digi Links QR codes use any other QR scanner.

## CONTENTS

CHAPTER	TITLE	PAGE No.	MONTH
<b>1</b>	<b>Relations and Functions</b>	<b>1-35</b>	
1.1	Introduction	1	June
1.2	Ordered Pair	2	
1.3	Cartesian Product	2	
1.4	Relations	6	
1.5	Functions	10	
1.6	Representation of Functions	15	
1.7	Types of Functions	17	
1.8	Special Cases of Functions	22	
1.9	Composition of Functions	26	
1.10	Identifying the Graphs of Linear, Quadratic, Cubic and Reciprocal Functions	29	
<b>2</b>	<b>Numbers and Sequences</b>	<b>36-84</b>	
2.1	Introduction	37	June
2.2	Euclid's Division Lemma	37	
2.3	Euclid's Division Algorithm	39	
2.4	Fundamental Theorem of Arithmetic	43	
2.5	Modular Arithmetic	46	
2.6	Sequences	52	
2.7	Arithmetic Progression	55	July
2.8	Series	62	
2.9	Geometric Progression	67	
2.10	Sum to $n$ terms of a Geometric Progression	73	
2.11	Special Series	76	
<b>3</b>	<b>Algebra</b>	<b>85-160</b>	
3.1	Introduction	85	July
3.2	Simultaneous Linear Equations in Three Variables	87	
3.3	GCD and LCM of Polynomials	93	
3.4	Rational Expressions	98	August
3.5	Square Root of Polynomials	103	
3.6	Quadratic Equations	106	September
3.7	Graph of Variations	123	
3.8	Quadratic Graphs	130	
3.9	Matrices	137	October

<b>4</b>	<b>Geometry</b>	<b>161-202</b>	
4.1	Introduction	161	July
4.2	Similarity	162	
4.3	Thales Theorem and Angle Bisector Theorem	171	August
4.4	Pythagoras Theorem	183	October
4.5	Circles and Tangents	188	
4.6	Concurrency Theorems	195	
<b>5</b>	<b>Coordinate Geometry</b>	<b>203-238</b>	
5.1	Introduction	203	August
5.2	Area of a Triangle	205	
5.3	Area of a Quadrilateral	207	
5.4	Inclination of a Line	212	
5.5	Straight Line	221	
5.6	General Form of a Straight Line	230	
<b>6</b>	<b>Trigonometry</b>	<b>239-268</b>	
6.1	Introduction	239	September
6.2	Trigonometric Identities	242	
6.3	Heights and Distances	250	November
<b>7</b>	<b>Mensuration</b>	<b>269-300</b>	
7.1	Introduction	269	November
7.2	Surface Area	270	
7.3	Volume	282	
7.4	Volume and Surface Area of Combined Solids	290	
7.5	Conversion of Solids from one Shape to another with no change in Volume	295	
<b>8</b>	<b>Statistics and Probability</b>	<b>301-334</b>	
8.1	Introduction	301	December
8.2	Measures of Dispersion	303	
8.3	Coefficient of Variation	314	
8.4	Probability	316	
8.5	Algebra of Events	324	
8.6	Addition Theorem of Probability	326	
	<b>Answers</b>	<b>335-343</b>	
	<b>Mathematical Terms</b>	<b>344-345</b>	



E-book



Evaluation



DIGI Links

# RELATIONS AND FUNCTIONS

“Mathematicians do not study objects, but relations between objects . . . Content to them is irrelevant: they are interested in form only” – Henri Poincare

# 1

**Gottfried Wilhelm Leibniz** (also known as von Leibniz) was a prominent German mathematician, philosopher, physicist and inventor. He wrote extensively on 26 topics covering wide range of subjects among which were Geology, Medicine, Biology, Epidemiology, Paleontology, Psychology, Engineering, Philology, Sociology, Ethics, History, Politics, Law and Music Theory.



Gottfried Wilhelm Leibniz  
(1646 – 1716)

In a manuscript Leibniz used the word “**function**” to mean any quantity varying from point to point of a curve. Leibniz provided the foundations of Formal Logic and Boolean Algebra, which are fundamental for modern day computers. For all his remarkable discoveries and contributions in various fields, Leibniz is hailed as “**The Father of Applied Sciences**”.



## Learning Outcomes

- To define and determine cartesian product of sets.
- To define a relation as a subset of cartesian product of sets.
- To understand function as a special relation.
- To represent a function through an arrow diagram, a set of ordered pairs, a table, a rule or a graph.
- To classify functions as one-one, many-one, onto, into and bijection.
- To study combination of functions through composition operation.
- To understand the graphs of linear, quadratic, cubic and reciprocal functions.



## 1.1 Introduction

The notion of sets provides the stimulus for learning higher concepts in mathematics. A set is a collection of well-defined objects. This means that a set is merely a collection of something which we may recognize. In this chapter, we try to extend the concept of sets in two forms called **Relations** and **Functions**. For doing this, we need to first know about cartesian products that can be defined between two non-empty sets.

It is quite interesting to note that most of the day-to-day situations can be represented mathematically either through a relation or a function. For example, the distance travelled by a vehicle in given time can be represented as a function. The price of a commodity can be expressed as a function in terms of its demand. The area of polygons and volume



of common objects like circle, right circular cone, right circular cylinder, sphere can be expressed as a function with one or more variables.

In class IX, we had studied the concept of sets. We have also seen how to form new sets from the given sets by taking union, intersection and complementation.

Now we are about to study a new set called “**cartesian product**” for the given sets  $A$  and  $B$ .

### 1.2 Ordered Pair

Observe the seating plan in an auditorium (Fig.1.1). To help orderly occupation of seats, tokens with numbers such as  $(1,5)$ ,  $(7,16)$ ,  $(3,4)$ ,  $(10,12)$  etc. are issued. The person who gets  $(4,10)$  will go to row 4 and occupy the 10<sup>th</sup> seat. Thus the first number denotes the row and the second number, the seat. Which seat will the visitor with token  $(5,9)$  occupy? Can he go to 9<sup>th</sup> row and take the 5<sup>th</sup> seat? Do  $(9,5)$  and  $(5,9)$  refer to the same location? No, certainly! What can you say about the tokens  $(2,3)$ ,  $(6,3)$  and  $(10,3)$ ?



Fig. 1.1

This is one example where a pair of numbers, written in a particular order, precisely indicates a location. Such a number pair is called an **ordered pair** of numbers. This notion is skillfully used to mathematize the concept of a “Relation”.

### 1.3 Cartesian Product

#### Illustration 1

Let us consider the following two sets.

$A$  is the set of 3 vegetables and  $B$  is the set of 4 fruits. That is,

$A = \{\text{carrot, brinjal, ladies finger}\}$  and  $B = \{\text{apple, orange, grapes, strawberry}\}$

What are the possible ways of choosing a vegetable with a fruit? (Fig.1.2)

Vegetables (A)	Fruits (B)
Carrot ( $c$ )	Apple ( $a$ )
Brinjal ( $b$ )	Orange ( $o$ )
Ladies finger ( $l$ )	Grapes ( $g$ )
	Strawberry ( $s$ )

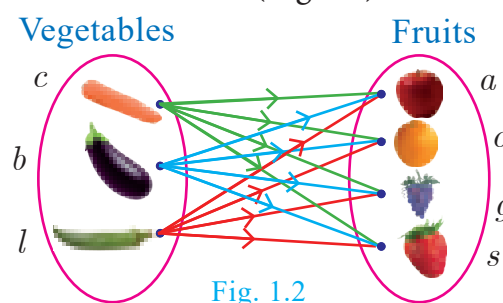

Fig. 1.2

We can select them in 12 distinct pairs as given below.

$(c, a), (c, o), (c, g), (c, s), (b, a), (b, o), (b, g), (b, s), (l, a), (l, o), (l, g), (l, s)$

This collection represents the cartesian product of the set of vegetables and set of fruits.

#### Definition

If  $A$  and  $B$  are two non-empty sets, then the set of all ordered pairs  $(a, b)$  such that  $a \in A, b \in B$  is called the **Cartesian Product of A and B**, and is denoted by  $A \times B$ .

Thus,  $A \times B = \{(a,b) | a \in A, b \in B\}$  (read as A cross B). Also note that  $A \times \phi = \phi$



**Note**

- $A \times B$  is the set of all possible ordered pairs between the elements of  $A$  and  $B$  such that the first coordinate is an element of  $A$  and the second coordinate is an element of  $B$ .
- $B \times A$  is the set of all possible ordered pairs between the elements of  $A$  and  $B$  such that the first coordinate is an element of  $B$  and the second coordinate is an element of  $A$ .
- In general  $(a, b) \neq (b, a)$ , in particular, if  $a = b$ , then  $(a, b) = (b, a)$ .
- The “cartesian product” is also referred as “cross product”.

**Illustration 2**

Let  $A = \{1, 2, 3\}$  and  $B = \{a, b\}$ . Write  $A \times B$  and  $B \times A$ ?

$A \times B = \{1,2,3\} \times \{a,b\} = \{(1,a), (1,b), (2,a), (2,b), (3,a), (3,b)\}$  (as shown in Fig.1.3)

$B \times A = \{a,b\} \times \{1,2,3\} = \{(a,1), (a,2), (a,3), (b,1), (b,2), (b,3)\}$  (as shown in Fig.1.3)

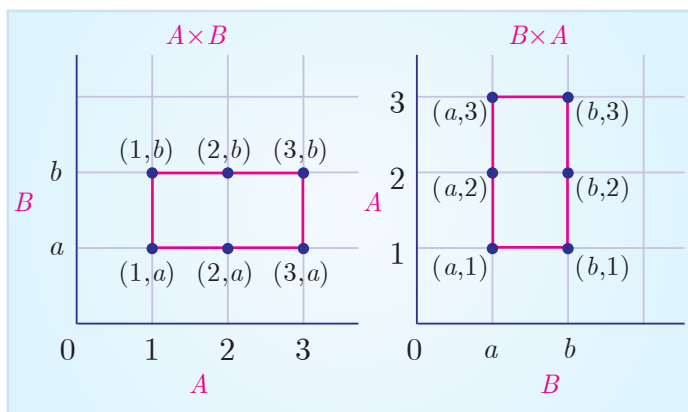

Fig. 1.3

**Thinking Corner**

When will  $A \times B$  be equal to  $B \times A$ ?

**Note**

- In general  $A \times B \neq B \times A$ , but  $n(A \times B) = n(B \times A)$
- $A \times B = \phi$  if and only if  $A = \phi$  or  $B = \phi$
- If  $n(A) = p$  and  $n(B) = q$  then  $n(A \times B) = pq$

**Recall of standard infinite sets**

Natural Numbers  $\mathbb{N} = \{1,2,3,4,\dots\}$ ; Whole Numbers  $\mathbb{W} = \{0,1,2,3, \dots\}$ ;

Integers  $\mathbb{Z} = \{\dots, -2,-1,0,1,2, \dots\}$ ; Rational Numbers  $\mathbb{Q} = \left\{ \frac{p}{q} \mid p, q \in \mathbb{Z}, q \neq 0 \right\}$ ;

Real Numbers  $\mathbb{R} = \mathbb{Q} \cup \mathbb{Q}'$ , where  $\mathbb{Q}'$  is the set of all irrational numbers.

**Illustration 3**

For example, let  $A$  be the set of numbers in the interval  $[3, 5]$  and  $B$  be the set of numbers in the interval  $[2,3]$ . Then the Cartesian product  $A \times B$  corresponds to the rectangular region shown in the Fig. 1.4. It consists of all points  $(x, y)$  within the region.

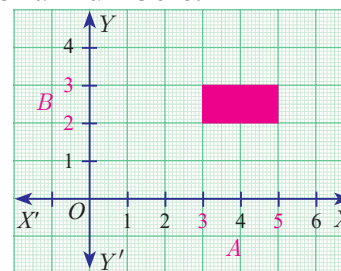

Fig. 1.4



**Progress Check**

1. For any two non-empty sets  $A$  and  $B$ ,  $A \times B$  is called as \_\_\_\_\_.
2. If  $n(A \times B) = 20$  and  $n(A) = 5$  then  $n(B)$  is \_\_\_\_\_.
3. If  $A = \{-1,1\}$  and  $B = \{-1,1\}$  then geometrically describe the set of points of  $A \times B$ .
4. If  $A, B$  are the line segments given by the intervals  $(-4, 3)$  and  $(-2, 3)$  respectively, represent the cartesian product of  $A$  and  $B$ .

**Note**

The set of all points in the cartesian plane can be viewed as the set of all ordered pairs  $(x, y)$  where  $x, y$  are real numbers. In fact,  $\mathbb{R} \times \mathbb{R}$  is the set of all points which we call as the cartesian plane.

**Activity 1**

Let  $A = \{x \mid x \in \mathbb{N}, x \leq 4\}$ ,  $B = \{y \mid y \in \mathbb{N}, y < 3\}$

Represent  $A \times B$  and  $B \times A$  in a graph sheet. Can you see the difference between  $A \times B$  and  $B \times A$ ?

**Example 1.1** If  $A = \{1,3,5\}$  and  $B = \{2,3\}$  then (i) find  $A \times B$  and  $B \times A$ .  
(ii) Is  $A \times B = B \times A$ ? If not why? (iii) Show that  $n(A \times B) = n(B \times A) = n(A) \times n(B)$

**Solution** Given that  $A = \{1,3,5\}$  and  $B = \{2,3\}$

$$(i) A \times B = \{1,3,5\} \times \{2,3\} = \{(1,2), (1,3), (3,2), (3,3), (5,2), (5,3)\} \dots(1)$$

$$B \times A = \{2,3\} \times \{1,3,5\} = \{(2,1), (2,3), (2,5), (3,1), (3,3), (3,5)\} \dots(2)$$

(ii) From (1) and (2) we conclude that  $A \times B \neq B \times A$  as  $(1,2) \neq (2,1)$  and  $(1,3) \neq (3,1)$ , etc.

(iii)  $n(A)=3$ ;  $n(B) = 2$ .

From (1) and (2) we observe that,  $n(A \times B) = n(B \times A) = 6$ ;

we see that,  $n(A) \times n(B) = 3 \times 2 = 6$  and  $n(B) \times n(A) = 2 \times 3 = 6$

Hence,  $n(A \times B) = n(B \times A) = n(A) \times n(B) = 6$ .

Thus,  $n(A \times B) = n(B \times A) = n(A) \times n(B)$ .

**Example 1.2** If  $A \times B = \{(3,2), (3,4), (5,2), (5,4)\}$  then find  $A$  and  $B$ .

**Solution**  $A \times B = \{(3,2), (3,4), (5,2), (5,4)\}$

We have  $A = \{\text{set of all first coordinates of elements of } A \times B\}$ .  $\therefore A = \{3,5\}$

$B = \{\text{set of all second coordinates of elements of } A \times B\}$ .  $\therefore B = \{2,4\}$

Thus  $A = \{3,5\}$  and  $B = \{2,4\}$ .

**Example 1.3** Let  $A = \{x \in \mathbb{N} \mid 1 < x < 4\}$ ,  $B = \{x \in \mathbb{W} \mid 0 \leq x < 2\}$  and  $C = \{x \in \mathbb{N} \mid x < 3\}$ . Then verify that

$$(i) A \times (B \cup C) = (A \times B) \cup (A \times C)$$

$$(ii) A \times (B \cap C) = (A \times B) \cap (A \times C)$$

**Solution**  $A = \{x \in \mathbb{N} \mid 1 < x < 4\} = \{2, 3\}$ ,  $B = \{x \in \mathbb{W} \mid 0 \leq x < 2\} = \{0,1\}$ ,

$C = \{x \in \mathbb{N} \mid x < 3\} = \{1,2\}$

$$(i) A \times (B \cup C) = (A \times B) \cup (A \times C)$$

$$B \cup C = \{0,1\} \cup \{1,2\} = \{0,1,2\}$$

$$A \times (B \cup C) = \{2,3\} \times \{0,1,2\} = \{(2,0), (2,1), (2,2), (3,0), (3,1), (3,2)\} \dots(1)$$

$$A \times B = \{2,3\} \times \{0,1\} = \{(2,0), (2,1), (3,0), (3,1)\}$$

$$A \times C = \{2,3\} \times \{1,2\} = \{(2,1), (2,2), (3,1), (3,2)\}$$

$$\begin{aligned} (A \times B) \cup (A \times C) &= \{(2,0), (2,1), (3,0), (3,1)\} \cup \{(2,1), (2,2), (3,1), (3,2)\} \\ &= \{(2,0), (2,1), (2,2), (3,0), (3,1), (3,2)\} \end{aligned} \quad \dots(2)$$

From (1) and (2),  $A \times (B \cup C) = (A \times B) \cup (A \times C)$  is verified.

$$\begin{aligned} \text{(ii)} \quad A \times (B \cap C) &= (A \times B) \cap (A \times C) \\ B \cap C &= \{0,1\} \cap \{1,2\} = \{1\} \\ A \times (B \cap C) &= \{2,3\} \times \{1\} = \{(2,1), (3,1)\} \end{aligned} \quad \dots (3)$$

$$\begin{aligned} A \times B &= \{2,3\} \times \{0,1\} = \{(2,0), (2,1), (3,0), (3,1)\} \\ A \times C &= \{2,3\} \times \{1,2\} = \{(2,1), (2,2), (3,1), (3,2)\} \\ (A \times B) \cap (A \times C) &= \{(2,0), (2,1), (3,0), (3,1)\} \cap \{(2,1), (2,2), (3,1), (3,2)\} \\ &= \{(2,1), (3,1)\} \end{aligned} \quad \dots (4)$$

From (3) and (4),  $A \times (B \cap C) = (A \times B) \cap (A \times C)$  is verified.

**Note**

The above two verified properties are called distributive property of cartesian product over union and intersection respectively. In fact, for any three sets  $A, B, C$  we have  
 (i)  $A \times (B \cup C) = (A \times B) \cup (A \times C)$  (ii)  $A \times (B \cap C) = (A \times B) \cap (A \times C)$ .

**1.3.1 Cartesian Product of three Sets**

If  $A, B, C$  are three non-empty sets then the **cartesian product** of **three sets** is the set of all possible **ordered triplets** given by

$$A \times B \times C = \{(a,b,c) \text{ for all } a \in A, b \in B, c \in C\}$$

**Illustration for Geometrical understanding of cartesian product of two and three sets**

Let  $A = \{0,1\}, B = \{0,1\}, C = \{0,1\}$

$$A \times B = \{0,1\} \times \{0,1\} = \{(0,0), (0,1), (1,0), (1,1)\}$$

Representing  $A \times B$  in the  $XY$ - plane we get a picture shown in Fig. 1.5.

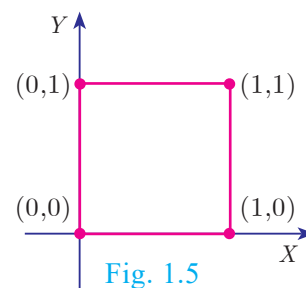

Fig. 1.5

$$\begin{aligned} (A \times B) \times C &= \{(0,0), (0,1), (1,0), (1,1)\} \times \{0,1\} \\ &= \{(0,0,0), (0,0,1), (0,1,0), (0,1,1), (1,0,0), (1,0,1), (1,1,0), (1,1,1)\} \end{aligned}$$

Representing  $A \times B \times C$  in the  $XYZ$ - space we get a picture as shown in Fig. 1.6.

Thus,  $A \times B$  represent vertices of a square in two dimensions and  $A \times B \times C$  represent vertices of a cube in three dimensions.

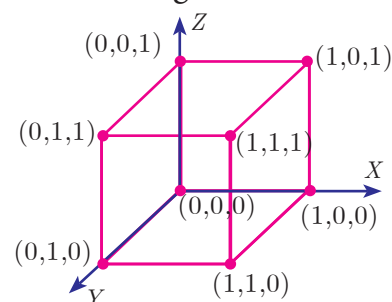

Fig. 1.6

**Note**

In general, cartesian product of two non-empty sets provides a shape in two dimensions and cartesian product of three non-empty sets provide an object in three dimensions.



### Exercise 1.1

- Find  $A \times B$ ,  $A \times A$  and  $B \times A$ 
  - $A = \{2, -2, 3\}$  and  $B = \{1, -4\}$
  - $A = B = \{p, q\}$
  - $A = \{m, n\}$ ;  $B = \phi$
- Let  $A = \{1, 2, 3\}$  and  $B = \{x \mid x \text{ is a prime number less than } 10\}$ . Find  $A \times B$  and  $B \times A$ .
- If  $B \times A = \{(-2, 3), (-2, 4), (0, 3), (0, 4), (3, 3), (3, 4)\}$  find  $A$  and  $B$ .
- If  $A = \{5, 6\}$ ,  $B = \{4, 5, 6\}$ ,  $C = \{5, 6, 7\}$ , Show that  $A \times A = (B \times B) \cap (C \times C)$ .
- Given  $A = \{1, 2, 3\}$ ,  $B = \{2, 3, 5\}$ ,  $C = \{3, 4\}$  and  $D = \{1, 3, 5\}$ , check if  $(A \cap C) \times (B \cap D) = (A \times B) \cap (C \times D)$  is true?
- Let  $A = \{x \in \mathbb{W} \mid x < 2\}$ ,  $B = \{x \in \mathbb{N} \mid 1 < x \leq 4\}$  and  $C = \{3, 5\}$ . Verify that
  - $A \times (B \cup C) = (A \times B) \cup (A \times C)$
  - $A \times (B \cap C) = (A \times B) \cap (A \times C)$
  - $(A \cup B) \times C = (A \times C) \cup (B \times C)$
- Let  $A =$  The set of all natural numbers less than 8,  $B =$  The set of all prime numbers less than 8,  $C =$  The set of even prime number. Verify that
  - $(A \cap B) \times C = (A \times C) \cap (B \times C)$
  - $A \times (B - C) = (A \times B) - (A \times C)$

## 1.4 Relations

Many day-to-day occurrences involve two objects that are connected with each other by some rule of correspondence. We say that the two objects are related under the specified rule. How shall we represent it? Here are some examples,

Relationship	Expressing using the symbol R	Representation as ordered pair
New Delhi <b>is the capital of</b> India	New Delhi R India	(New Delhi, India)
Line $AB$ <b>is perpendicular to</b> line $XY$	line $AB$ R line $XY$	(line $AB$ , line $XY$ )
$-1$ <b>is greater than</b> $-5$	$-1$ R $-5$	$(-1, -5)$
$\ell$ <b>is a line of symmetry for</b> $\Delta PQR$	$\ell$ R $\Delta PQR$	$(\ell, \Delta PQR)$

How are New Delhi and India related? We may expect the response, “New Delhi is the capital of India”. But there are several ways in which ‘New Delhi’ and ‘India’ are related. Here are some possible answers.

- New Delhi is the capital of India.
- New Delhi is in the northern part of India.
- New Delhi is one of the largest cities of India etc.,

So, when we wish to specify a particular relation, providing only one ordered pair

(New Delhi, India) it may not be practically helpful. If we ask the relation in the following set of ordered pairs,  $\{(New\ Delhi,\ India), (Washington,\ USA), (Beijing,\ China), (London,\ U.K.), (Kathmandu,\ Nepal)\}$  then specifying the relation is easy.



### Progress Check

Let  $A = \{1, 2, 3, 4\}$  and  $B = \{a, b, c\}$ .

1. Which of the following are relations from $A$ to $B$ ?	2. Which of the following are relations from $B$ to $A$ ?
(i) $\{(1, b), (1, c), (3, a), (4, b)\}$	(i) $\{(c, a), (c, b), (c, 1)\}$
(ii) $\{(1, a), (b, 4), (c, 3)\}$	(ii) $\{(c, 1), (c, 2), (c, 3), (c, 4)\}$
(iii) $\{(1, a), (a, 1), (2, b), (b, 2)\}$	(iii) $\{(a, 4), (b, 3), (c, 2)\}$

### Illustration 4

Students in a class	$S_1$	$S_2$	$S_3$	$S_4$	$S_5$	$S_6$	$S_7$	$S_8$	$S_9$	$S_{10}$
Heights (in feet)	4.5	5.2	5	4.5	5	5.1	5.2	5	4.7	4.9

Let us define a relation between heights of corresponding students. (Fig.1.7)

$$R = \{(heights, students)\}$$

$$R = \{(4.5, S_1), (4.5, S_4), (4.7, S_9), (4.9, S_{10}), (5, S_3), (5, S_5), (5, S_8), (5.1, S_6), (5.2, S_2), (5.2, S_7)\}$$

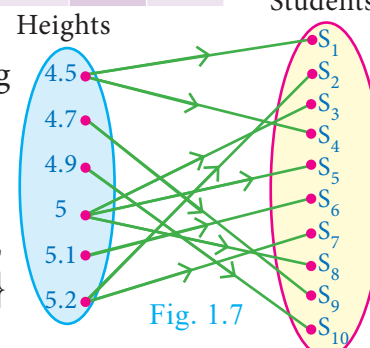

Fig. 1.7

### Definition

Let  $A$  and  $B$  be any two non-empty sets. A 'relation'  $R$  from  $A$  to  $B$  is a subset of  $A \times B$  satisfying some specified conditions. If  $x \in A$  is related to  $y \in B$  through  $R$ , then we write it as  $x R y$ .  $x R y$  if and only if  $(x, y) \in R$ .

The **domain** of the relation  $R = \{x \in A \mid x R y, \text{ for some } y \in B\}$

The **co-domain** of the relation  $R$  is  $B$

The **range** of the relation  $R = \{y \in B \mid x R y, \text{ for some } x \in A\}$

From these definitions, we note that domain of  $R \subseteq A$ , co-domain of  $R = B$  and range of  $R \subseteq B$ .



### Illustration 5

Let  $A = \{1, 2, 3, 4, 5\}$  and  $B = \{\text{Mathi, Arul, John}\}$

A relation  $R$  between the above sets  $A$  and  $B$  can be represented by an arrow diagram (Fig. 1.8).

Then, domain of  $R = \{1, 2, 3, 4\}$

range of  $R = \{\text{Mathi, Arul, John}\} = \text{co-domain of } R$ .

Note that domain of  $R$  is a proper subset of  $A$ .

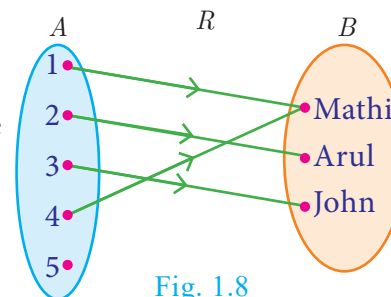

Fig. 1.8



### Activity 2

Let  $A$  and  $B$  be the set of lines in  $xy$ -plane such that  $A$  consists of lines parallel to  $X$ -axis. For  $x \in A$ ,  $y \in B$ , let  $R$  be a relation from  $A$  to  $B$  defined by  $xRy$  if  $x$  is perpendicular to  $y$ . Find the elements of  $B$  using a graph sheet.

### Illustration 6

Let  $A = \{1,3,5,7\}$  and  $B = \{4,8\}$ . If  $R$  is a relation defined by “is less than” from  $A$  to  $B$ , then  $1R4$  ( $\because$  1 is less than 4). Similarly, it is observed that  $1R8$ ,  $3R4$ ,  $3R8$ ,  $5R8$ ,  $7R8$

Equivalently  $R = \{(1,4), (1,8), (3,4), (3,8), (5,8), (7,8)\}$

### Note

In the above illustration  $A \times B = \{(1,4), (1,8), (3,4), (3,8), (5,4), (5,8), (7,4), (7,8)\}$   
 $R = \{(1,4), (1,8), (3,4), (3,8), (5,8), (7,8)\}$  We see that  $R$  is a subset of  $A \times B$ .

### Illustration 7

In a particular area of a town, let us consider ten families  $A, B, C, D, E, F, G, H, I$  and  $J$  with two children. Among these, families  $B, F, I$  have two girls;  $D, G, J$  have one boy and one girl; the remaining have two boys. Let us define a relation  $R$  by  $xRy$ , where  $x$  denote the number of boys and  $y$  denote the family with  $x$  number of boys. Represent this situation as a relation through ordered pairs and arrow diagram.

Since the domain of the relation  $R$  is concerned about the number of boys, and we are considering families with two children, the domain of  $R$  will consist of three elements given by  $\{0,1,2\}$ , where 0, 1, 2 represent the number of boys say no, one, two boys respectively. We note that families with two girls are the ones with no boys. Hence the relation  $R$  is given by

$$R = \{(0, B), (0, F), (0, I), (1, D), (1, G), (1, J), (2, A), (2, C), (2, E), (2, H)\}$$

This relation is shown in an arrow diagram (Fig.1.9).

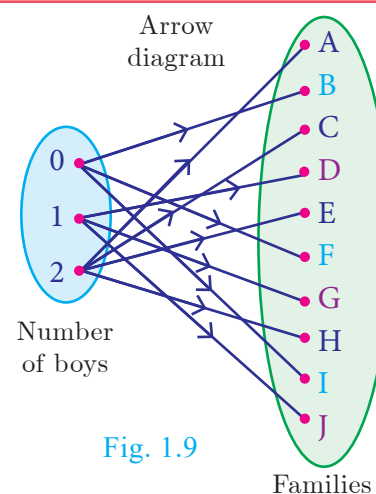

Fig. 1.9

**Example 1.4** Let  $A = \{3,4,7,8\}$  and  $B = \{1,7,10\}$ . Which of the following sets are relations from  $A$  to  $B$ ?

- (i)  $R_1 = \{(3,7), (4,7), (7,10), (8,1)\}$       (ii)  $R_2 = \{(3,1), (4,12)\}$   
 (iii)  $R_3 = \{(3,7), (4,10), (7,7), (7,8), (8,11), (8,7), (8,10)\}$

**Solution**  $A \times B = \{(3,1), (3,7), (3,10), (4,1), (4,7), (4,10), (7,1), (7,7), (7,10), (8,1), (8,7), (8,10)\}$

- (i) We note that,  $R_1 \subseteq A \times B$ . Thus,  $R_1$  is a relation from  $A$  to  $B$ .  
 (ii) Here,  $(4,12) \in R_2$ , but  $(4,12) \notin A \times B$ . So,  $R_2$  is not a relation from  $A$  to  $B$ .  
 (iii) Here,  $(7,8) \in R_3$ , but  $(7,8) \notin A \times B$ . So,  $R_3$  is not a relation from  $A$  to  $B$ .

**Note**

- A relation may be represented algebraically either by the roster method or by the set builder method.
- An arrow diagram is a visual representation of a relation.

**Example 1.5** The arrow diagram shows (Fig.1.10) a relationship between the sets  $P$  and  $Q$ . Write the relation in (i) Set builder form (ii) Roster form (iii) What is the domain and range of  $R$ .

**Solution**

- (i) Set builder form of  $R = \{(x, y) \mid y = x - 2, x \in P, y \in Q\}$   
 (ii) Roster form  $R = \{(5, 3), (6, 4), (7, 5)\}$   
 (iii) Domain of  $R = \{5, 6, 7\}$  and range of  $R = \{3, 4, 5\}$

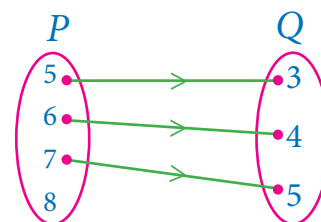

Fig. 1.10

**'Null relation'**

Let us consider the following example. Suppose  $A = \{-3, -2, -1\}$  and  $B = \{1, 2, 3, 4\}$ . A relation from  $A$  to  $B$  is defined as  $a - b = 8$  i.e., there is no pair  $(a, b)$  such that  $a - b = 8$ . Thus  $R$  contains no element and so  $R = \phi$ .

A relation which contains no element is called a "Null relation".

**DO YOU KNOW?**

If  $n(A) = p$ ,  $n(B) = q$ , then the total number of relations that exist from  $A$  to  $B$  is  $2^{pq}$ .

**Exercise 1.2**

- Let  $A = \{1, 2, 3, 7\}$  and  $B = \{3, 0, -1, 7\}$ , which of the following are relation from  $A$  to  $B$ ?
  - $R_1 = \{(2, 1), (7, 1)\}$
  - $R_2 = \{(-1, 1)\}$
  - $R_3 = \{(2, -1), (7, 7), (1, 3)\}$
  - $R_4 = \{(7, -1), (0, 3), (3, 3), (0, 7)\}$
- Let  $A = \{1, 2, 3, 4, \dots, 45\}$  and  $R$  be the relation defined as "is square of a number" on  $A$ . Write  $R$  as a subset of  $A \times A$ . Also, find the domain and range of  $R$ .
- A Relation  $R$  is given by the set  $\{(x, y) \mid y = x + 3, x \in \{0, 1, 2, 3, 4, 5\}\}$ . Determine its domain and range.
- Represent each of the given relations by (a) an arrow diagram, (b) a graph and (c) a set in roster form, wherever possible.
  - $\{(x, y) \mid x = 2y, x \in \{2, 3, 4, 5\}, y \in \{1, 2, 3, 4\}\}$
  - $\{(x, y) \mid y = x + 3, x, y \text{ are natural numbers} < 10\}$
- A company has four categories of employees given by Assistants ( $A$ ), Clerks ( $C$ ), Managers ( $M$ ) and an Executive Officer ( $E$ ). The company provides ₹10,000, ₹25,000, ₹50,000 and ₹1,00,000 as salaries to the people who work in the categories

$A$ ,  $C$ ,  $M$  and  $E$  respectively. If  $A_1, A_2, A_3, A_4$  and  $A_5$  were Assistants;  $C_1, C_2, C_3, C_4$  were Clerks;  $M_1, M_2, M_3$  were managers and  $E_1, E_2$  were Executive officers and if the relation  $R$  is defined by  $xRy$ , where  $x$  is the salary given to person  $y$ , express the relation  $R$  through an ordered pair and an arrow diagram.

### 1.5 Functions

Among several relations that exist between two non-empty sets, some special relations are important for further exploration. Such relations are called “**Functions**”.

#### Illustration 8

A company has 5 employees in different categories. If we consider their salary distribution for a month as shown by arrow diagram in Fig.1.11, we see that there is only one salary associated for every employee of the company.

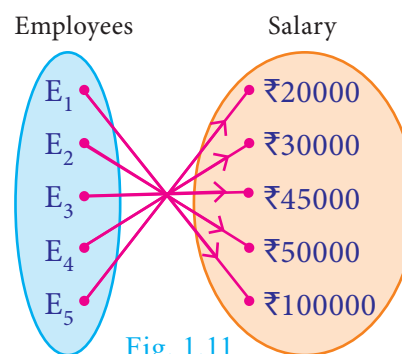

Fig. 1.11

Here are various real life situations illustrating some special relations:

1. Consider the set  $A$  of all of your classmates; corresponding to each student, there is only one age.
2. You go to a shop to buy a book. If you take out a book, there is only one price corresponding to it; it does not have two prices corresponding to it. (of course, many books may have the same price).
3. You are aware of Boyle’s law. Corresponding to a given value of pressure  $P$ , there is only one value of volume  $V$ .
4. In Economics, the quantity demanded can be expressed as  $Q = 360 - 4P$ , where  $P$  is the price of the commodity. We see that for each value of  $P$ , there is only one value of  $Q$ . Thus the quantity demanded  $Q$  depend on the price  $P$  of the commodity.

We often come across certain relations, in which, for each element of a set  $A$ , there is only one corresponding element of a set  $B$ . Such relations are called **functions**. We usually use the symbol  $f$  to denote a functional relation.

#### Definition

A relation  $f$  between two non-empty sets  $X$  and  $Y$  is called a **function** from  $X$  to  $Y$  if, for each  $x \in X$  there exists only one  $y \in Y$  such that  $(x, y) \in f$ .

That is,  $f = \{(x, y) | \text{for all } x \in X, y \in Y\}$ .

A function  $f$  from  $X$  to  $Y$  is written as  $f : X \rightarrow Y$ .

Comparing the definitions of relation and function, we see that every function is a relation. Thus, functions are subsets of relations and relations are subsets of cartesian product. (Fig.1.12(a))

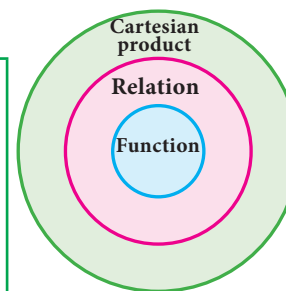

Fig. 1.12(a)

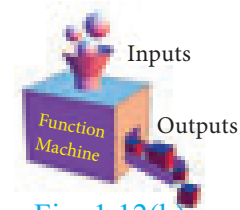

Fig. 1.12(b)





A function  $f$  can be thought as a mechanism (or device) (Fig.1.12(b)), which gives a unique output  $f(x)$  to every input  $x$ .

A function is also called as a mapping or transformation.

DO YOU KNOW?

### Note

If  $f : X \rightarrow Y$  is a function then

- The set  $X$  is called the domain of the function  $f$  and the set  $Y$  is called its co-domain.
- If  $f(a) = b$ , then  $b$  is called 'image' of  $a$  under  $f$  and  $a$  is called a 'pre-image' of  $b$ .
- The set of all images of the elements of  $X$  under  $f$  is called the 'range' of  $f$ .
- $f : X \rightarrow Y$  is a function only if
  - (i) every element in the domain of  $f$  has an image.
  - (ii) the image is unique.
- If  $A$  and  $B$  are finite sets such that  $n(A) = p$ ,  $n(B) = q$  then the total number of functions that exist from  $A$  to  $B$  is  $q^p$ .
- In this chapter we always consider  $f$  to be a real valued function.
- Describing domain of a function

(i) Let  $f(x) = \frac{1}{x+1}$ . If  $x = -1$  then  $f(-1)$  is not defined. Hence  $f$  is defined for all real numbers except at  $x = -1$ . So, domain of  $f$  is  $\mathbb{R} - \{-1\}$ .

(ii) Let  $f(x) = \frac{1}{x^2 - 5x + 6}$ ; If  $x = 2, 3$  then  $f(2)$  and  $f(3)$  are not defined. Hence  $f$  is defined for all real numbers except at  $x = 2$  and  $3$ . So, domain of  $f = \mathbb{R} - \{2, 3\}$ .



### Progress Check

1. Relations are subsets of \_\_\_\_\_. Functions are subsets of \_\_\_\_\_.
2. True or False: All the elements of a relation should have images.
3. True or False: All the elements of a function should have images.
4. True or False: If  $R : A \rightarrow B$  is a relation then the domain of  $R = A$ .
5. If  $f : \mathbb{N} \rightarrow \mathbb{N}$  is defined as  $f(x) = x^2$  the image of 1 and 2 are \_\_\_\_\_ and \_\_\_\_\_.
6. What is the difference between relation and function?
7. Let  $A$  and  $B$  be two non-empty finite sets. Then which one among the following two collection is large?
  - (i) The number of relations between  $A$  and  $B$ .
  - (ii) The number of functions between  $A$  and  $B$ .

### Illustration 9 - Testing for functions

#### Representation by Arrow diagram

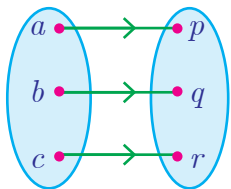
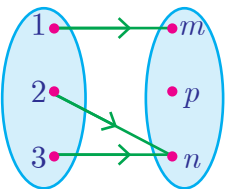
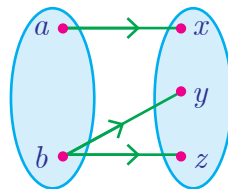
 <p>This represents a function. Each input corresponds to a single output.</p> <p style="text-align: center;">Fig. 1.13(a)</p>	 <p>This represents a function. Each input corresponds to a single output.</p> <p style="text-align: center;">Fig. 1.13(b)</p>	 <p>This is not a function. One of the input <math>b</math> is associated with two outputs.</p> <p style="text-align: center;">Fig. 1.13(c)</p>
---	---	--

Functions play very important role in the understanding of higher ideas in mathematics. They are basic tools to convert from one form to another form. In this sense, functions are widely applied in Engineering Sciences.

#### Note

The range of a function is a subset of its co-domain.

**Example 1.6** Let  $X = \{1, 2, 3, 4\}$  and  $Y = \{2, 4, 6, 8, 10\}$  and  $R = \{(1, 2), (2, 4), (3, 6), (4, 8)\}$ . Show that  $R$  is a function and find its domain, co-domain and range?

**Solution** Pictorial representation of  $R$  is given in Fig.1.14. From the diagram, we see that for each  $x \in X$ , there exists only one  $y \in Y$ . Thus all elements in  $X$  have only one image in  $Y$ . Therefore  $R$  is a function.

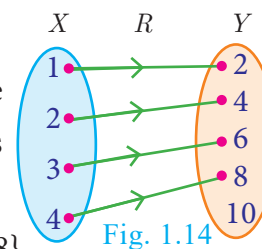

Domain  $X = \{1, 2, 3, 4\}$ ; Co-domain  $Y = \{2, 4, 6, 8, 10\}$ ; Range of  $f = \{2, 4, 6, 8\}$ .

**Example 1.7** A relation  $f: X \rightarrow Y$  is defined by  $f(x) = x^2 - 2$  where,  $X = \{-2, -1, 0, 3\}$  and  $Y = \mathbb{R}$ .

(i) List the elements of  $f$  (ii) Is  $f$  a function?

**Solution**  $f(x) = x^2 - 2$  where  $X = \{-2, -1, 0, 3\}$

$$(i) \quad f(-2) = (-2)^2 - 2 = 2; \quad f(-1) = (-1)^2 - 2 = -1$$

$$f(0) = (0)^2 - 2 = -2; \quad f(3) = (3)^2 - 2 = 7$$

$$\therefore f = \{(-2, 2), (-1, -1), (0, -2), (3, 7)\}$$

(ii) We note that each element in the domain of  $f$  has a unique image. Therefore,  $f$  is a function.

#### Thinking Corner

Is the relation representing the association between planets and their respective moons a function?

**Example 1.8** If  $X = \{-5, 1, 3, 4\}$  and  $Y = \{a, b, c\}$ , then which of the following relations are functions from  $X$  to  $Y$ ?

- (i)  $R_1 = \{(-5, a), (1, a), (3, b)\}$       (ii)  $R_2 = \{(-5, b), (1, b), (3, a), (4, c)\}$   
 (iii)  $R_3 = \{(-5, a), (1, a), (3, b), (4, c), (1, b)\}$

**Solution**

- (i)  $R_1 = \{(-5, a), (1, a), (3, b)\}$

We may represent the relation  $R_1$  in an arrow diagram (Fig.1.15(a)).

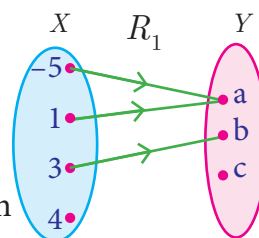

Fig. 1.15(a)

$R_1$  is not a function as  $4 \in X$  does not have an image in  $Y$ .

- (ii)  $R_2 = \{(-5, b), (1, b), (3, a), (4, c)\}$

Arrow diagram of  $R_2$  is shown in Fig.1.15(b).

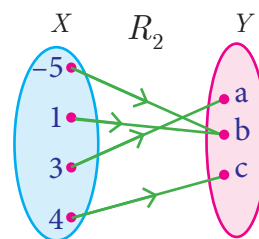

Fig. 1.15(b)

$R_2$  is a function as each element of  $X$  has a unique image in  $Y$ .

- (iii)  $R_3 = \{(-5, a), (1, a), (3, b), (4, c), (1, b)\}$

Representing  $R_3$  in an arrow diagram (Fig.1.15(c)).

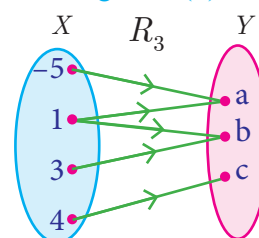

Fig. 1.15(c)

$R_3$  is not a function as  $1 \in X$  has two images  $a \in Y$  and  $b \in Y$ .

Note that the image of an element should always be unique.

**Example 1.9** Given  $f(x) = 2x - x^2$ ,

find (i)  $f(1)$  (ii)  $f(x+1)$  (iii)  $f(x) + f(1)$

**Solution** (i)  $x = 1$ , we get

$$f(1) = 2(1) - (1)^2 = 2 - 1 = 1$$

(ii)  $x = x+1$ , we get

$$f(x+1) = 2(x+1) - (x+1)^2 = 2x+2 - (x^2+2x+1) = -x^2+1$$

(iii)  $f(x) + f(1) = (2x - x^2) + 1 = -x^2 + 2x + 1$

[Note that  $f(x) + f(1) \neq f(x+1)$ . In general  $f(a+b)$  is not equal to  $f(a)+f(b)$ ]



**Exercise 1.3**

- Let  $f = \{(x, y) \mid x, y \in N \text{ and } y = 2x\}$  be a relation on  $N$ . Find the domain, co-domain and range. Is this relation a function?
- Let  $X = \{3, 4, 6, 8\}$ . Determine whether the relation  $R = \{(x, f(x)) \mid x \in X, f(x) = x^2 + 1\}$  is a function from  $X$  to  $N$ ?

3. Given the function  $f : x \rightarrow x^2 - 5x + 6$ , evaluate
- (i)  $f(-1)$  (ii)  $f(2a)$   
 (iii)  $f(2)$  (iv)  $f(x-1)$

4. A graph representing the function  $f(x)$  is given in Fig.1.16 it is clear that  $f(9) = 2$ .

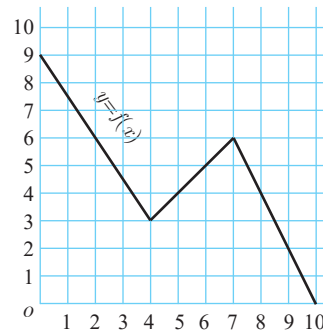

Fig. 1.16

- (i) Find the following values of the function  
 (a)  $f(0)$  (b)  $f(7)$  (c)  $f(2)$  (d)  $f(10)$
- (ii) For what value of  $x$  is  $f(x) = 1$ ?
- (iii) Describe the following (i) Domain (ii) Range.
- (iv) What is the image of 6 under  $f$ ?

5. Let  $f(x) = 2x+5$ . If  $x \neq 0$  then find  $\frac{f(x+2) - f(2)}{x}$ .

6. A function  $f$  is defined by  $f(x) = 2x - 3$

- (i) find  $\frac{f(0) + f(1)}{2}$ .
- (ii) find  $x$  such that  $f(x) = 0$ .
- (iii) find  $x$  such that  $f(x) = x$ .
- (iv) find  $x$  such that  $f(x) = f(1-x)$ .

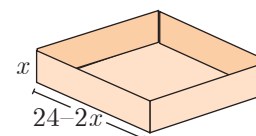
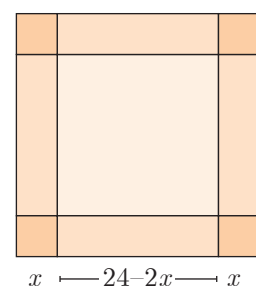

Fig. 1.17

7. An open box is to be made from a square piece of material, 24 cm on a side, by cutting equal squares from the corners and turning up the sides as shown (Fig.1.17). Express the volume  $V$  of the box as a function of  $x$ .

8. A function  $f$  is defined by  $f(x) = 3 - 2x$ . Find  $x$  such that  $f(x^2) = (f(x))^2$ .

9. A plane is flying at a speed of 500 km per hour. Express the distance 'd' travelled by the plane as function of time  $t$  in hours.

10. The data in the adjacent table depicts the length of a person forearm and their corresponding height. Based on this data, a student finds a relationship between the height ( $y$ ) and the forearm length( $x$ ) as  $y = ax + b$ , where  $a, b$  are constants.

Length ' $x$ ' of forearm (in cm)	Height ' $y$ ' (in inches)
35	56
45	65
50	69.5
55	74

- (i) Check if this relation is a function.  
 (ii) Find  $a$  and  $b$ .



- (iii) Find the height of a person whose forehand length is 40 cm.
- (iv) Find the length of forehand of a person if the height is 53.3 inches.

### 1.6 Representation of Functions

A function may be represented by

- (a) a set of ordered pairs
- (b) a table form
- (c) an arrow diagram
- (d) a graphical form

Let  $f : A \rightarrow B$  be a function

#### (a) Set of ordered pairs

The set  $f = \{(x, y) \mid y = f(x), x \in A\}$  of all **ordered pairs** represent a function.

#### (b) Table form

The values of  $x$  and the values of their respective images under  $f$  can be given in the form of a **table**.

#### (c) Arrow diagram

An **arrow diagram** indicates the elements of the domain of  $f$  and their respective images by means of arrows.

#### (d) Graph

The ordered pairs in the collection  $f = \{(x, y) \mid y = f(x), x \in A\}$  are plotted as points in the  $XY$ - plane. The **graph** of  $f$  is the totality of all such points.

Every function can be represented by a curve in a graph. But not every curve drawn in a graph will represent a function.

The following test will help us in determining whether a given curve is a function or not.

#### 1.6.1 Vertical line test

A curve drawn in a graph represents a function, if every **vertical line** intersects the curve in at most one point.

**Example 1.10** Using vertical line test, determine which of the following curves (Fig.1.18(a), 1.18(b), 1.18(c), 1.18(d)) represent a function?

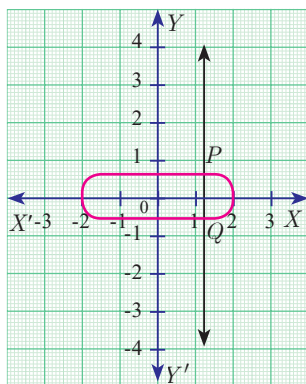

Fig. 1.18(a)

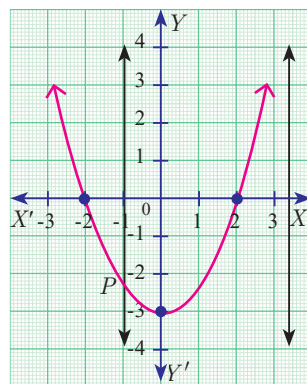

Fig. 1.18(b)

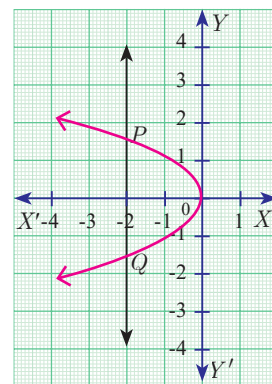

Fig. 1.18(c)

**Solution** The curves in Fig.1.18 (a) and Fig.1.18 (c) do not represent a function as the vertical lines meet the curves in two points  $P$  and  $Q$ .

The curves in Fig.1.18 (b) and Fig.1.18 (d) represent a function as the vertical lines meet the curve in at most one point.

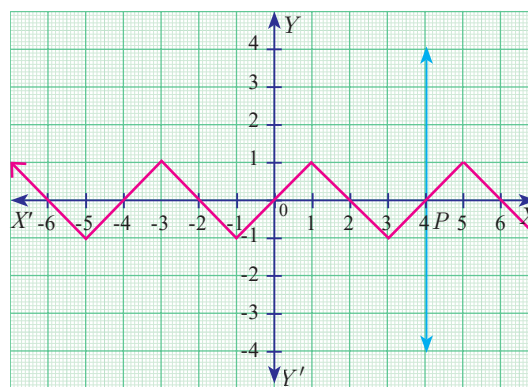

Fig. 1.18(d)

**Note**

Any equation represented in a graph is usually called a curve.

**Example 1.11** Let  $A = \{1, 2, 3, 4\}$  and  $B = \{2, 5, 8, 11, 14\}$  be two sets. Let  $f : A \rightarrow B$  be a function given by  $f(x) = 3x - 1$ . Represent this function

- (i) by arrow diagram
- (ii) in a table form
- (iii) as a set of ordered pairs
- (iv) in a graphical form

**Solution**

$A = \{1, 2, 3, 4\}; B = \{2, 5, 8, 11, 14\}; f(x) = 3x - 1$

$f(1) = 3(1) - 1 = 3 - 1 = 2; f(2) = 3(2) - 1 = 6 - 1 = 5$

$f(3) = 3(3) - 1 = 9 - 1 = 8; f(4) = 3(4) - 1 = 12 - 1 = 11$

**(i) Arrow diagram**

Let us represent the function  $f : A \rightarrow B$  by an arrow diagram (Fig.1.19).

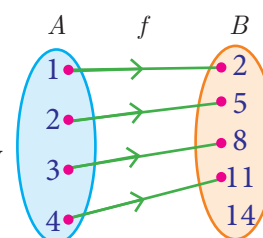

Fig. 1.19

**(ii) Table form**

The given function  $f$  can be represented in a tabular form as given below

$x$	1	2	3	4
$f(x)$	2	5	8	11

**(iii) Set of ordered pairs**

The function  $f$  can be represented as a set of ordered pairs as

$f = \{(1, 2), (2, 5), (3, 8), (4, 11)\}$

**(iv) Graphical form**

In the adjacent  $XY$ -plane the points  $(1, 2), (2, 5), (3, 8), (4, 11)$  are plotted (Fig.1.20).

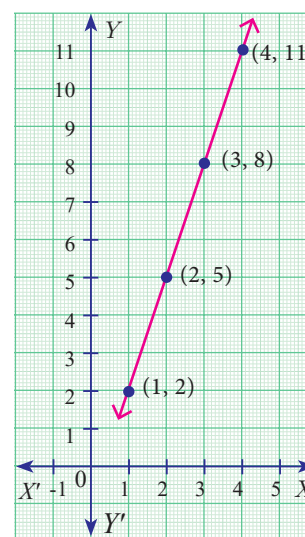

Fig. 1.20

## 1.7 Types of Functions

In this section, we will discuss the following types of functions with suitable examples.

- (i) one – one (ii) many – one (iii) onto (iv) into

### 1.7.1 One – one function

Let us assume that we have a cell phone with proper working condition. If you make a usual call to your friend then you can make only one call at a time (Fig.1.21).

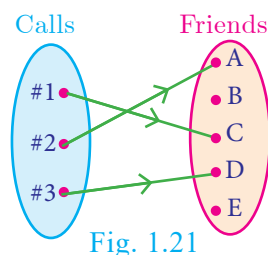

If we treat making calls as a function, then it will be one - one.

A function  $f : A \rightarrow B$  is called **one – one function** if distinct elements of  $A$  have distinct images in  $B$ .

A one-one function is also called an **injection**.

Equivalently,

If for all  $a_1, a_2 \in A$ ,  $f(a_1) = f(a_2)$  implies  $a_1 = a_2$ , then  $f$  is called **one – one function**.

#### Illustration 10

$$A = \{1,2,3,4\} \text{ and } B = \{a,b,c,d,e\}$$

- (i) Let  $f = \{(1,a), (2,b), (3,d), (4,c)\}$

In Fig. 1.22, for different elements in  $A$ , there are different images in  $B$ .

Hence  $f$  is a one – one function.

- (ii) Let  $g = \{(1,b), (2,b), (3,c), (4,e)\}$

$g$  is a function from  $A$  to  $B$  such that  $g(1) = g(2) = b$ , but  $1 \neq 2$ . Thus two distinct elements 1 and 2 in the first set  $A$  have same image  $b$  the second set in  $B$  (Fig.1.23). Hence,  $g$  is not a one–one function.

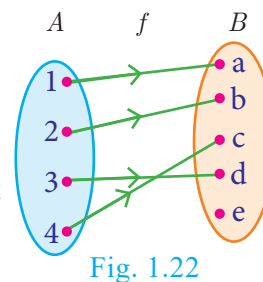

Fig. 1.22

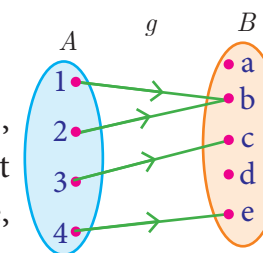

Fig. 1.23

### 1.7.2 Many – one function

In a theatre complex three films  $F_1, F_2, F_3$  are shown. Seven persons ( $P_1$  to  $P_7$ ) arrive at the theatre and buy tickets as shown (Fig.1.24).

If the selection of films is considered as a relation, then this is a function which is many–one, since more than one person may choose to watch the same film.

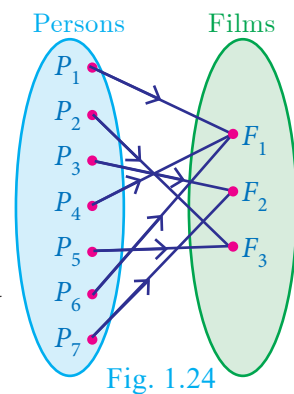

Fig. 1.24

A function  $f : A \rightarrow B$  is called **many-one function** if two or more elements of  $A$  have same image in  $B$ .

In other words, a function  $f : A \rightarrow B$  is called many-one if  $f$  it is not one-one.

**Illustration 11**

Let  $A = \{1,2,3,4\}$  and  $B = \{a,b,c\}$ ,  $f = \{(1,a), (2,a), (3,b), (4,c)\}$

Then  $f$  is a function from  $A$  to  $B$  in which different elements 1 and 2 of  $A$  have the same image  $a$  in  $B$ . Hence  $f$  is a many - one function.

**1.7.3 Onto function**

In a mobile phone assume that there are 3 persons in the contact. If every person in the contact receives a call, then the function representing making calls will be **onto**. (Fig.1.25)

A function  $f : A \rightarrow B$  is said to be **onto function** if the range of  $f$  is equal to the co-domain of  $f$ .

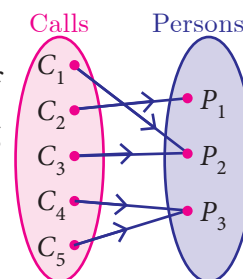

Fig. 1.25

In other words, every element in the co-domain  $B$  has a pre-image in the domain  $A$ .

An onto function is also called a **surjection**.

**Note**

If  $f : A \rightarrow B$  is an onto function then, the range of  $f = B$ .

**Illustration 12**

Let  $A = \{x,y,z\}$ ,  $B = \{l,m,n\}$ ;

Range of  $f = \{l,m,n\} = B$  (Fig.1.26)

Hence  $f$  is an onto function.

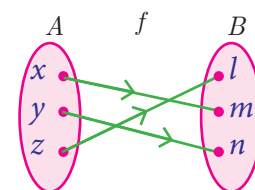

Fig. 1.26

**1.7.4 Into function**

In a home appliance showroom, the products television, air conditioner, washing machine and water heater were provided with 20% discount as new year sale offer. If the selection of the above products by the three customers  $C_1, C_2, C_3$  is considered as a function then the following diagram (Fig.1.27) will represent an **into function**.

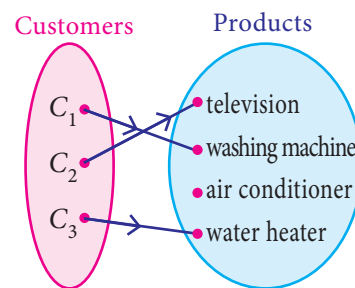

Fig. 1.27

During winter season customers usually do not prefer buying air conditioner. Here air conditioner is not chosen by any customer. This is an example of into function.



A function  $f : A \rightarrow B$  is called an **into function** if there exists atleast one element in  $B$  which is not the image of any element of  $A$ .

That is the range of  $f$  is a proper subset of the co-domain of  $f$ .

In other words, a function  $f : A \rightarrow B$  is called ‘into’ if it is not ‘onto’.

**Illustration 13**

Let  $A = \{1,2,3\}$  and  $B = \{w, x, y, z\}$ ,  $f = \{(1, w), (2, z), (3, x)\}$

Here, range of  $f = \{w, x, z\} \subset B$  (Fig.1.28)

$\therefore f$  is a into function.

Note that  $y \in B$  is not an image of any element in  $A$ .

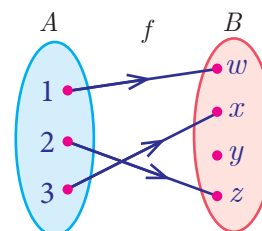

Fig. 1.28

**1.7.5 Bijection**

Consider the circle where each letter of the English alphabet is changed from inner portion to a letter in the outer portion.

Thus  $A \rightarrow D$ ,  $B \rightarrow E$ ,  $C \rightarrow F$ , ...  $Z \rightarrow C$ . We call this circle as ‘cipher circle’. (Fig.1.29) In this way if we try to change the word ‘HELLO’ then it will become ‘KHOOR’. Now using the same circle if we substitute for each outer letter the corresponding inner letter we will get back the word ‘HELLO’. This process of converting



Cipher Circle  
Fig. 1.29

from one form to an other form and receiving back the required information is called **bijection**. This process is widely used in the study of secret codes called **cryptography**.

If a function  $f : A \rightarrow B$  is both one–one and onto, then  $f$  is called a **bijection** from  $A$  to  $B$ .

**Illustration 14**

one to one and onto function (Bijection)	
<p>Fig. 1.30</p>	<p>Distinct elements of <math>A</math> have distinct images in <math>B</math> and every element in <math>B</math> has a pre-image in <math>A</math>.</p>

**Illustration 15**

One to One	Many to One
<p>Fig. 1.31</p>	<p>Fig. 1.32</p>
Distinct elements of $A$ have distinct images in $B$ .	Two or more elements of $A$ have same image in $B$ .

**Note**

A one – one and onto function is also called a one – one correspondence.

**Thinking Corner**

Can there be a one to many function?

Onto	Into
<p>Fig. 1.33</p>	<p>Fig. 1.34</p>
<p><b>Range of <math>f =</math> co-domain</b> ( Every element in <math>B</math> has a pre-image in <math>A</math> )</p>	<p><b>Range of <math>f</math> is a proper subset of co-domain</b> (There exists at least one element in <math>B</math> which is not the image of any element of <math>A</math>)</p>

To determine whether the given function is one–one or not the following test may help us.

**1.7.6 Horizontal Line Test**

Previously we have seen the vertical line test. Now let us see the **horizontal line** test. “A function represented in a graph is one–one, if every horizontal line intersects the curve in at most one point”.

**Example 1.12** Using horizontal line test (Fig.1.35 (a), 1.35 (b), 1.35 (c)), determine which of the following functions are one – one.

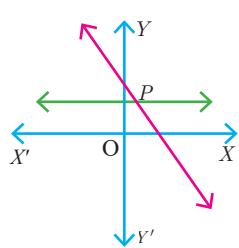

Fig. 1.35(a)

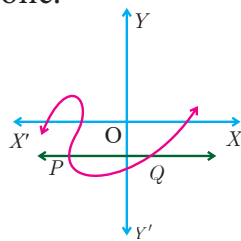

Fig. 1.35(b)

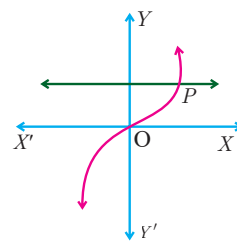

Fig. 1.35(c)

**Solution** The curves in Fig.1.35 (a) and Fig.1.35 (c) represent a one–one function as the horizontal lines meet the curves in only one point  $P$ .

The curve in Fig. 1.35 (b) does not represent a one–one function, since, the horizontal line intersects the curve at two points  $P$  and  $Q$ .

**Example 1.13** Let  $A = \{1, 2, 3\}$ ,  $B = \{4, 5, 6, 7\}$  and  $f = \{(1, 4), (2, 5), (3, 6)\}$  be a function from  $A$  to  $B$ . Show that  $f$  is one – one but not onto function.

**Solution**  $A = \{1, 2, 3\}$ ,  $B = \{4, 5, 6, 7\}$ ;  $f = \{(1, 4), (2, 5), (3, 6)\}$

Then  $f$  is a function from  $A$  to  $B$  and for different elements in  $A$ , there are different images in  $B$ . Hence  $f$  is one–one function. Note that the element 7 in the co-domain does not have any pre-image in the domain. Hence  $f$  is not onto (Fig.1.36).

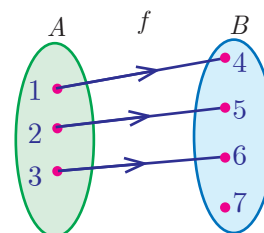

Fig. 1.36

$\therefore f$  is one–one but not an onto function.

**Example 1.14** If  $A = \{-2, -1, 0, 1, 2\}$  and  $f: A \rightarrow B$  is an onto function defined by  $f(x) = x^2 + x + 1$  then find  $B$ .

**Solution** Given  $A = \{-2, -1, 0, 1, 2\}$  and  $f(x) = x^2 + x + 1$ .

$$f(-2) = (-2)^2 + (-2) + 1 = 3;$$

$$f(-1) = (-1)^2 + (-1) + 1 = 1$$

$$f(0) = 0^2 + 0 + 1 = 1;$$

$$f(1) = 1^2 + 1 + 1 = 3$$

$$f(2) = 2^2 + 2 + 1 = 7$$

$$\therefore B = \{1, 3, 7\}.$$

**Example 1.15** Let  $f$  be a function  $f: \mathbb{N} \rightarrow \mathbb{N}$  be defined by  $f(x) = 3x + 2, x \in \mathbb{N}$

- (i) Find the images of 1, 2, 3      (ii) Find the pre-images of 29, 53  
(ii) Identify the type of function

**Solution** The function  $f: \mathbb{N} \rightarrow \mathbb{N}$  is defined by  $f(x) = 3x + 2$

(i) If  $x = 1$ ,  $f(1) = 3(1) + 2 = 5$

If  $x = 2$ ,  $f(2) = 3(2) + 2 = 8$

If  $x = 3$ ,  $f(3) = 3(3) + 2 = 11$

The images of 1, 2, 3 are 5, 8, 11 respectively.

(ii) If  $x$  is the pre-image of 29, then  $f(x) = 29$ . Hence  $3x + 2 = 29$

$$3x = 27 \Rightarrow x = 9.$$

Similarly, if  $x$  is the pre-image of 53, then  $f(x) = 53$ . Hence  $3x + 2 = 53$

$$3x = 51 \Rightarrow x = 17.$$

Thus the pre-images of 29 and 53 are 9 and 17 respectively.

- (iii) Since different elements of  $\mathbb{N}$  have different images in the co-domain, the function  $f$  is one – one function.

The co-domain of  $f$  is  $\mathbb{N}$ .

But the range of  $f = \{5, 8, 11, 14, 17, \dots\}$  is a proper subset of  $\mathbb{N}$ .

$\therefore f$  is not an onto function. That is,  $f$  is an into function.

Thus  $f$  is one – one and into function.

**Example 1.16** Forensic scientists can determine the height (in cm) of a person based on the length of the thigh bone. They usually do so using the function  $h(b) = 2 \cdot 47b + 54 \cdot 10$  where  $b$  is the length of the thigh bone.

- (i) Verify the function  $h$  is one – one or not.
- (ii) Also find the height of a person if the length of his thigh bone is 50 cm.
- (iii) Find the length of the thigh bone if the height of a person is 147 · 96 cm.

**Solution** (i) To check if  $h$  is one – one, we assume that  $h(b_1) = h(b_2)$ .

$$\text{Then we get, } 2 \cdot 47b_1 + 54 \cdot 10 = 2 \cdot 47b_2 + 54 \cdot 10$$

$$2 \cdot 47b_1 = 2 \cdot 47b_2$$

$$\Rightarrow b_1 = b_2$$

Thus,  $h(b_1) = h(b_2) \Rightarrow b_1 = b_2$ . So, the function  $h$  is one – one.

(ii) If the length of the thigh bone  $b = 50$ , then the height is

$$h(50) = (2 \cdot 47 \times 50) + 54 \cdot 10 = 177 \cdot 6 \text{ cm.}$$

(iii) If the height of a person is 147 · 96 cm, then  $h(b) = 147 \cdot 96$  and so the length of the thigh bone is given by

$$2 \cdot 47b + 54 \cdot 10 = 147 \cdot 96$$

$$\Rightarrow 2 \cdot 47b = 147 \cdot 96 - 54 \cdot 10 = 93 \cdot 86$$

$$b = \frac{93 \cdot 86}{2 \cdot 47} = 38$$

Therefore, the length of the thigh bone is 38 cm.



### Activity 3

Check whether the following curves represent a function. In the case of a function, check whether it is one-one? (Hint: Use the vertical and the horizontal line tests)

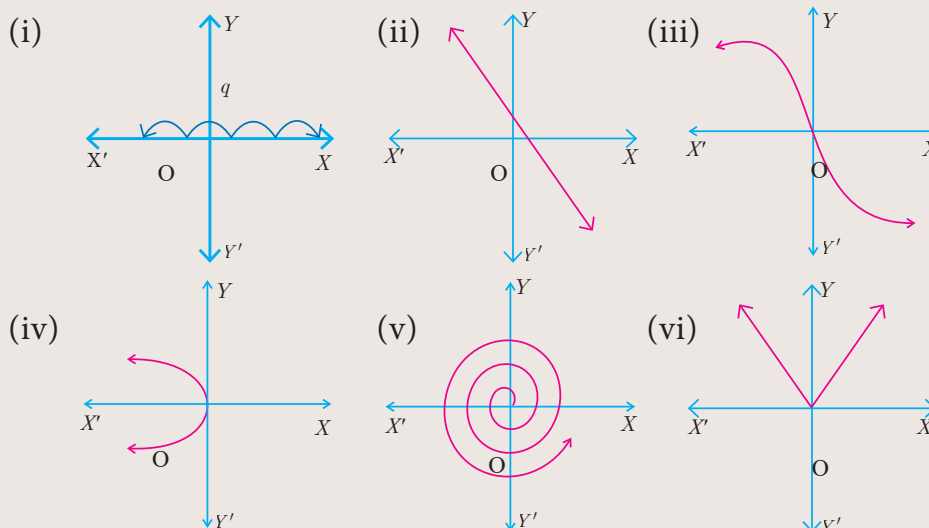

## 1.8 Special Cases of Functions

There are some special cases of a function which will be very useful. We discuss some of them below

- (i) Constant function
- (ii) Identity function
- (iii) Real – valued function



**(i) Constant function**

A function  $f : A \rightarrow B$  is called a **constant function** if the range of  $f$  contains only one element. That is,  $f(x) = c$ , for all  $x \in A$  and for some fixed  $c \in B$ .

**Illustration 16**

From Fig.1.37,  $A = \{a, b, c, d\}$ ,  $B = \{1, 2, 3\}$  and  $f = \{(a, 3), (b, 3), (c, 3), (d, 3)\} \therefore f(x) = 3 \forall x \in A$ ,  
Range of  $f = \{3\}$ ,  $f$  is a constant function.

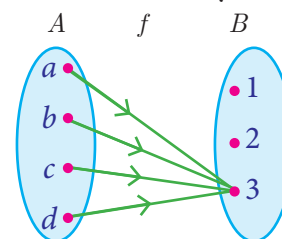

Fig. 1.37

**(ii) Identity function**

Let  $A$  be a non-empty set. Then the function  $f : A \rightarrow A$  defined by  $f(x) = x$  for all  $x \in A$  is called an **identity function** on  $A$  and is denoted by  $I_A$ .

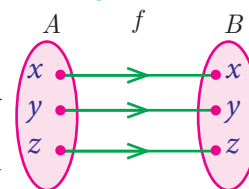

Fig. 1.38

**Illustration 17**

If  $A = \{a, b, c\}$  then  $f = I_A = \{(a, a), (b, b), (c, c)\}$  is an identity function on  $A$ .

**Thinking Corner**

Is an identity function one to one function?

**(iii) Real valued function**

A function  $f : A \rightarrow B$  is called a **real valued function** if the range of  $f$  is a subset of the set of all real numbers  $\mathbb{R}$ . That is,  $f(A) \subseteq \mathbb{R}$ ,  $\forall a \in A$ .

**Progress Check****State True or False.**

- All one - one functions are onto functions.
- There will be no one - one function from  $A$  to  $B$  when  $n(A) = 4$ ,  $n(B) = 3$ .
- All onto functions are one - one functions.
- There will be no onto function from  $A$  to  $B$  when  $n(A) = 4$ ,  $n(B) = 5$ .
- If  $f$  is a bijection from  $A$  to  $B$ , then  $n(A) = n(B)$ .
- If  $n(A) = n(B)$ , then  $f$  is a bijection from  $A$  to  $B$ .
- All constant functions are bijections.

**Example 1.17** Let  $f$  be a function from  $\mathbb{R}$  to  $\mathbb{R}$  defined by  $f(x) = 3x - 5$ . Find the values of  $a$  and  $b$  given that  $(a, 4)$  and  $(1, b)$  belong to  $f$ .

**Solution**  $f(x) = 3x - 5$  can be written as  $f = \{(x, 3x - 5) \mid x \in \mathbb{R}\}$

$(a, 4)$  means the image of  $a$  is 4. i.e.,  $f(a) = 4$

$$3a - 5 = 4 \Rightarrow a = 3$$

$(1, b)$  means the image of 1 is  $b$ . i.e.,  $f(1) = b$

$$3(1) - 5 = b \Rightarrow b = -2$$

**Example 1.18** If the function  $f: \mathbb{R} \rightarrow \mathbb{R}$  is defined by  $f(x) = \begin{cases} 2x + 7; & x < -2 \\ x^2 - 2; & -2 \leq x < 3 \\ 3x - 2; & x \geq 3 \end{cases}$ , then find the values of

- (i)  $f(4)$       (ii)  $f(-2)$       (iii)  $f(4) + 2f(1)$       (iv)  $\frac{f(1) - 3f(4)}{f(-3)}$

**Solution**

The function  $f$  is defined by three values in intervals I, II, III as shown by the side

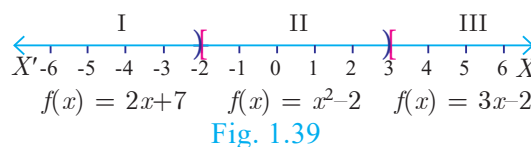

For a given value of  $x = a$ , find out the interval at which the point  $a$  is located, there after find  $f(a)$  using the particular value defined in that interval.

- (i) First, we see that,  $x = 4$  lie in the third interval.

$$\therefore f(x) = 3x - 2; f(4) = 3(4) - 2 = 10$$

- (ii)  $x = -2$  lies in the second interval.

$$\therefore f(x) = x^2 - 2; f(-2) = (-2)^2 - 2 = 2$$

- (iii) From (i),  $f(4) = 10$ .

To find  $f(1)$ , first we see that  $x = 1$  lies in the second interval.

$$\therefore f(x) = x^2 - 2 \Rightarrow f(1) = 1^2 - 2 = -1$$

$$f(4) + 2f(1) = 10 + 2(-1) = 8$$

- (iv) We know that  $f(1) = -1$  and  $f(4) = 10$ .

For finding  $f(-3)$ , we see that  $x = -3$ , lies in the first interval.

$$\therefore f(x) = 2x + 7; \text{ thus, } f(-3) = 2(-3) + 7 = 1$$

Hence, 
$$\frac{f(1) - 3f(4)}{f(-3)} = \frac{-1 - 3(10)}{1} = -31$$



**Exercise 1.4**

1. Determine whether the graph given below represent functions. Give reason for your answers concerning each graph.

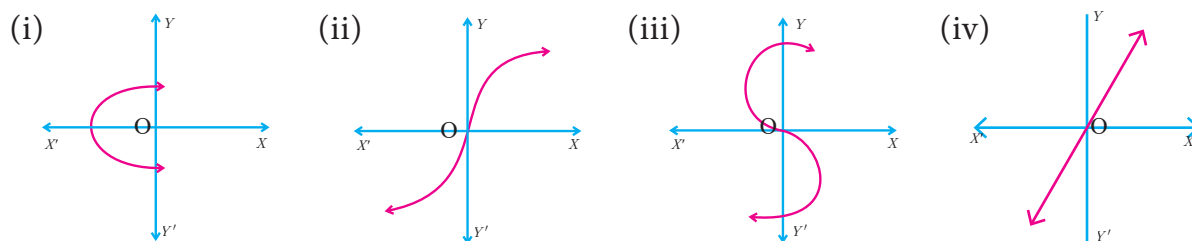

2. Let  $f: A \rightarrow B$  be a function defined by  $f(x) = \frac{x}{2} - 1$ , where  $A = \{2, 4, 6, 10, 12\}$ ,  $B = \{0, 1, 2, 4, 5, 9\}$ . Represent  $f$  by  
 (i) set of ordered pairs (ii) a table (iii) an arrow diagram (iv) a graph
3. Represent the function  $f = \{(1, 2), (2, 2), (3, 2), (4, 3), (5, 4)\}$  through  
 (i) an arrow diagram (ii) a table form (iii) a graph
4. Show that the function  $f: \mathbb{N} \rightarrow \mathbb{N}$  defined by  $f(x) = 2x - 1$  is one-one but not onto.
5. Show that the function  $f: \mathbb{N} \rightarrow \mathbb{N}$  defined by  $f(m) = m^2 + m + 3$  is one-one function.
6. Let  $A = \{1, 2, 3, 4\}$  and  $B = \mathbb{N}$ . Let  $f: A \rightarrow B$  be defined by  $f(x) = x^3$  then,  
 (i) find the range of  $f$  (ii) identify the type of function
7. In each of the following cases state whether the function is bijective or not. Justify your answer.  
 (i)  $f: \mathbb{R} \rightarrow \mathbb{R}$  defined by  $f(x) = 2x + 1$  (ii)  $f: \mathbb{R} \rightarrow \mathbb{R}$  defined by  $f(x) = 3 - 4x^2$
8. Let  $A = \{-1, 1\}$  and  $B = \{0, 2\}$ . If the function  $f: A \rightarrow B$  defined by  $f(x) = ax + b$  is an onto function? Find  $a$  and  $b$ .
9. If the function  $f$  is defined by  $f(x) = \begin{cases} x + 2; & x > 1 \\ 2; & -1 \leq x \leq 1 \\ x - 1; & -3 < x < -1 \end{cases}$  find the values of  
 (i)  $f(3)$  (ii)  $f(0)$  (iii)  $f(-1 \cdot 5)$  (iv)  $f(2) + f(-2)$
10. A function  $f: [-5, 9] \rightarrow \mathbb{R}$  is defined as follows:  

$$f(x) = \begin{cases} 6x + 1; & -5 \leq x < 2 \\ 5x^2 - 1; & 2 \leq x < 6 \\ 3x - 4; & 6 \leq x \leq 9 \end{cases}$$
  
 Find (i)  $f(-3) + f(2)$  (ii)  $f(7) - f(1)$  (iii)  $2f(4) + f(8)$  (iv)  $\frac{2f(-2) - f(6)}{f(4) + f(-2)}$
11. The distance  $S$  an object travels under the influence of gravity in time  $t$  seconds is given by  $S(t) = \frac{1}{2}gt^2 + at + b$  where, ( $g$  is the acceleration due to gravity),  $a, b$  are constants. Verify whether the function  $S(t)$  is one-one or not.
12. The function ' $t$ ' which maps temperature in Celsius ( $C$ ) into temperature in Fahrenheit ( $F$ ) is defined by  $t(C) = F$  where  $F = \frac{9}{5}C + 32$ . Find,  
 (i)  $t(0)$  (ii)  $t(28)$  (iii)  $t(-10)$   
 (iv) the value of  $C$  when  $t(C) = 212$   
 (v) the temperature when the Celsius value is equal to the Fahrenheit value.

### 1.9 Composition of Functions

When a car driver depresses the accelerator pedal, it controls the flow of fuel which in turn influences the speed of the car. Likewise, the composition of two functions is a kind of ‘chain reaction’, where the functions act upon one after another (Fig.1.40).

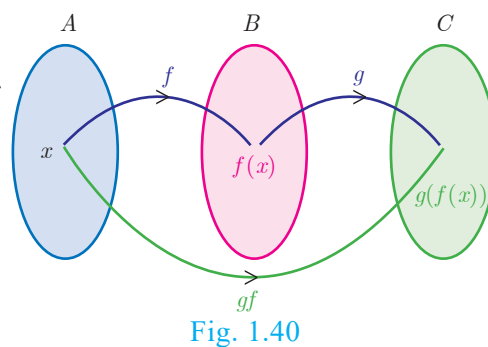

We can explain this further with the concept that a function is a ‘process’. If  $f$  and  $g$  are two functions then the composition  $g(f(x))$  (Fig.1.41) is formed in two steps.

- (i) Feed an input (say  $x$ ) to  $f$ ;
- (ii) Feed the output  $f(x)$  to  $g$  to get  $g(f(x))$  and call it  $gf(x)$ .

#### Illustration

Consider the set  $A$  of all students, who appeared in class  $X$  of Board Examination. Each student appearing in the Board Examination is assigned a roll number. In order to have confidentiality, the Board arranges to deface the roll number of each student and assigns a code number to each roll number.

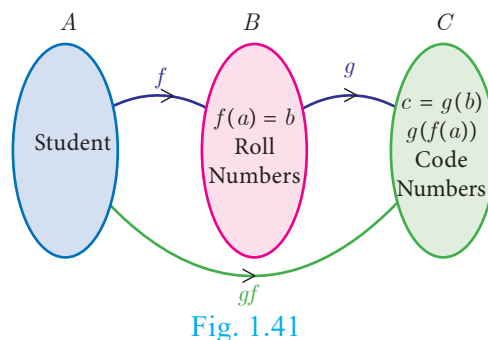

Let  $A$  be the set of all students appearing for the board exam.  $B \subseteq \mathbb{N}$  be the set all roll numbers and  $C \subseteq \mathbb{N}$  be the set of all code numbers (Fig.1.41). This gives rise to two functions  $f : A \rightarrow B$  and  $g : B \rightarrow C$  given by  $b = f(a)$  be the roll number assigned to student  $a$ ,  $c = g(b)$  be the code number assigned to roll number  $b$ , where  $a \in A$ ,  $b \in B$  and  $c \in C$ .

We can write  $c = g(b) = g(f(a))$ .

Thus, by the combination of these two functions, each student is eventually attached a code number. This idea leads to the following definition.

#### Definition

Let  $f : A \rightarrow B$  and  $g : B \rightarrow C$  be two functions (Fig.1.42). Then the composition of  $f$  and  $g$  denoted by  $g \circ f$  is defined as the function  $g \circ f(x) = g(f(x)) \forall x \in A$ .

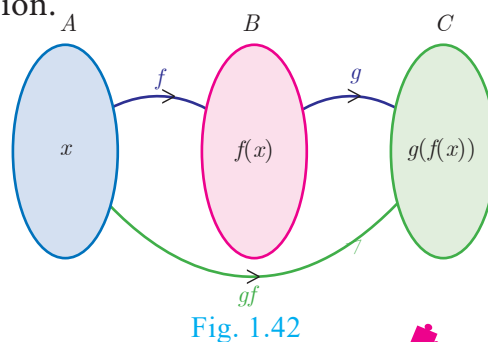

**Example 1.19** Find  $f \circ g$  and  $g \circ f$  when  $f(x) = 2x + 1$  and  $g(x) = x^2 - 2$

**Solution**  $f(x) = 2x + 1$ ,  $g(x) = x^2 - 2$

$$f \circ g(x) = f(g(x)) = f(x^2 - 2) = 2(x^2 - 2) + 1 = 2x^2 - 3$$

$$g \circ f(x) = g(f(x)) = g(2x + 1) = (2x + 1)^2 - 2 = 4x^2 + 4x - 1$$

Thus  $f \circ g = 2x^2 - 3$ ,  $g \circ f = 4x^2 + 4x - 1$ . From the above, we see that  $f \circ g \neq g \circ f$ .

#### Thinking Corner

If  $f(x) = x^m$  and  $g(x) = x^n$  does  $f \circ g = g \circ f$ ?



**Note**

Generally,  $f \circ g \neq g \circ f$  for any two functions  $f$  and  $g$ . So, composition of functions is not commutative.

**Example 1.20** Represent the function  $f(x) = \sqrt{2x^2 - 5x + 3}$  as a composition of two functions.

**Solution**  $f_2(x) = 2x^2 - 5x + 3$  and  $f_1(x) = \sqrt{x}$

$$\begin{aligned} f(x) &= \sqrt{2x^2 - 5x + 3} = \sqrt{f_2(x)} \\ &= f_1[f_2(x)] = f_1 \circ f_2(x) \end{aligned}$$

**Example 1.21** If  $f(x) = 3x - 2$ ,  $g(x) = 2x + k$  and if  $f \circ g = g \circ f$ , then find the value of  $k$ .

**Solution**  $f(x) = 3x - 2$ ,  $g(x) = 2x + k$

$$f \circ g(x) = f(g(x)) = f(2x + k) = 3(2x + k) - 2 = 6x + 3k - 2$$

$$f \circ g(x) = 6x + 3k - 2.$$

$$g \circ f(x) = g(3x - 2) = 2(3x - 2) + k$$

$$g \circ f(x) = 6x - 4 + k.$$

Given that  $f \circ g = g \circ f$

$$\therefore 6x + 3k - 2 = 6x - 4 + k$$

$$6x - 6x + 3k - k = -4 + 2 \Rightarrow k = -1$$



The Composition  $g \circ f(x)$  exists only when range of  $f$  is a subset of domain of  $g$ .

**Example 1.22** Find  $k$  if  $f \circ f(k) = 5$  where  $f(k) = 2k - 1$ .

**Solution**  $f \circ f(k) = f(f(k))$

$$= 2(2k - 1) - 1 = 4k - 3.$$

$$f \circ f(k) = 4k - 3$$

But,  $f \circ f(k) = 5$

$$\therefore 4k - 3 = 5 \Rightarrow k = 2.$$

### 1.9.1 Composition of three functions

Let  $A, B, C, D$  be four sets and let  $f: A \rightarrow B$ ,  $g: B \rightarrow C$  and  $h: C \rightarrow D$  be three functions (Fig.1.43). Using composite functions  $f \circ g$  and  $g \circ h$ , we get two new functions like  $(f \circ g) \circ h$  and  $f \circ (g \circ h)$ .

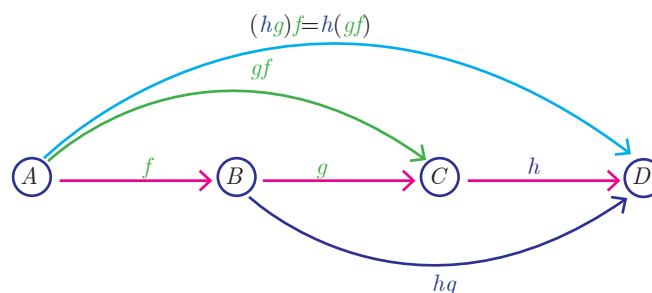

Fig. 1.43

We observed that the composition of functions is not commutative. The natural question is about the associativity of the operation.

**Note**

Composition of three functions is always associative. That is,  $f \circ (g \circ h) = (f \circ g) \circ h$

**Example 1.23** If  $f(x) = 2x + 3$ ,  $g(x) = 1 - 2x$  and  $h(x) = 3x$ . Prove that  $f \circ (g \circ h) = (f \circ g) \circ h$

**Solution**  $f(x) = 2x + 3$ ,  $g(x) = 1 - 2x$ ,  $h(x) = 3x$

Now,  $(f \circ g)(x) = f(g(x)) = f(1 - 2x) = 2(1 - 2x) + 3 = 5 - 4x$

Then,  $(f \circ g) \circ h(x) = (f \circ g)(h(x)) = (f \circ g)(3x) = 5 - 4(3x) = 5 - 12x$  ....(1)

$(g \circ h)(x) = g(h(x)) = g(3x) = 1 - 2(3x) = 1 - 6x$

$\Rightarrow f \circ (g \circ h)(x) = f(1 - 6x) = 2(1 - 6x) + 3 = 5 - 12x$  ....(2)

From (1) and (2), we get  $(f \circ g) \circ h = f \circ (g \circ h)$

**Example 1.24** Find  $x$  if  $gff(x) = fgg(x)$ , given  $f(x) = 3x + 1$  and  $g(x) = x + 3$ .

**Solution**  $gff(x) = g[f\{f(x)\}]$  (This means “ $g$  of  $f$  of  $f$  of  $x$ ”)

$= g[f(3x + 1)] = g[3(3x + 1) + 1] = g(9x + 4)$

$g(9x + 4) = [(9x + 4) + 3] = 9x + 7$

$fgg(x) = f[g\{g(x)\}]$  (This means “ $f$  of  $g$  of  $g$  of  $x$ ”)

$= f[g(x + 3)] = f[(x + 3) + 3] = f(x + 6)$

$f(x + 6) = [3(x + 6) + 1] = 3x + 19$

These two quantities being equal, we get  $9x + 7 = 3x + 19$ . Solving this equation we obtain  $x = 2$ .



**Progress Check**

State your answer for the following questions by selecting the correct option.

1. Composition of functions is commutative  
 (a) Always true      (b) Never true      (c) Sometimes true
2. Composition of functions is associative  
 (a) Always true      (b) Never true      (c) Sometimes true



**Activity 4**

Given that  $h(x) = f \circ g(x)$ , fill in the table for  $h(x)$

$x$	$f(x)$
1	2
2	3
3	1
4	4

$x$	$g(x)$
1	2
2	4
3	3
4	1

$x$	$h(x)$
1	3
2	-
3	-
4	-

How to find  $h(1)$  ?

$h(x) = f \circ g(x)$

$h(1) = f \circ g(1)$

$= f(2) = 3$

$\therefore h(1) = 3$

## 1.10 Identifying the Graphs of Linear, Quadratic, Cubic and Reciprocal Functions

Graphs provide visualization of curves and functions. Hence, graphs help a lot in understanding the concepts in a much efficient way.

In this section, we will be discussing about the identification of some of the functions through their graphs. In particular, we discuss graphs of Linear, Quadratic, Cubic and Reciprocal functions.

### 1.10.1 Linear Function

A function  $f : \mathbb{R} \rightarrow \mathbb{R}$  defined by  $f(x) = mx + c$ ,  $m \neq 0$  is called a **linear function**. Geometrically this represents a straight line in the graph.

Some Specific Linear Functions and their graphs are given below.

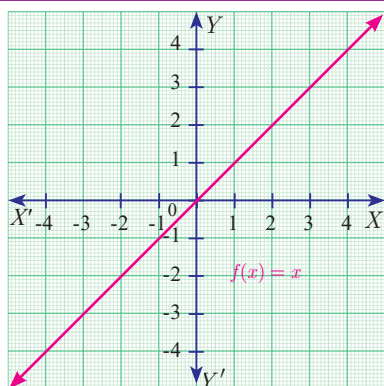
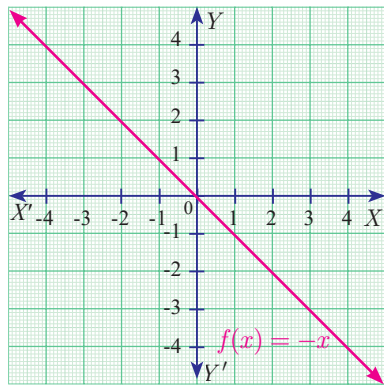
No.	Function	Domain and Definition	Graph
1	The identity function	$f : \mathbb{R} \rightarrow \mathbb{R}$ defined by $f(x) = x$	 <p style="text-align: center;">Fig. 1.44</p>
2	Additive inverse function	$f : \mathbb{R} \rightarrow \mathbb{R}$ defined by $f(x) = -x$	 <p style="text-align: center;">Fig. 1.45</p>

### 1.10.2 Modulus or Absolute valued Function

$f : \mathbb{R} \rightarrow [0, \infty)$  defined by  $f(x) = |x|$

$$= \begin{cases} x; & x \geq 0 \\ -x; & x < 0 \end{cases}$$

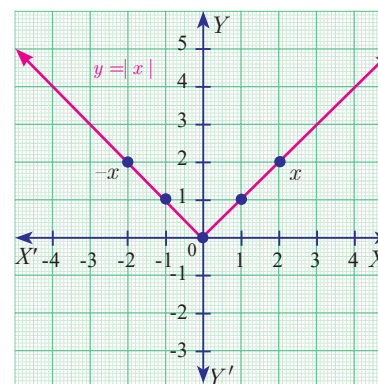

**Note**

- Modulus function is not a linear function but it is composed of two linear functions  $x$  and  $-x$ .
- Linear functions are always one-one functions and has applications in Cryptography as well as in several branches of Science and Technology.

**1.10.3 Quadratic Function**

A function  $f : \mathbb{R} \rightarrow \mathbb{R}$  defined by  $f(x) = ax^2 + bx + c, (a \neq 0)$  is called a **quadratic function**.

Some specific quadratic functions and their graphs

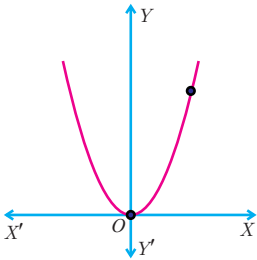
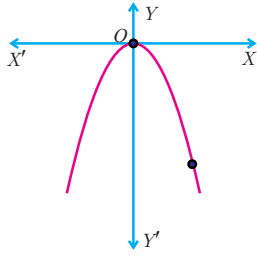
Function, Domain, Range and Definition	Graph
$f : \mathbb{R} \rightarrow \mathbb{R}$ defined by $f(x) = x^2, x \in \mathbb{R}. f(x) \in [0, \infty)$	 <p>Fig. 1.47(a)</p>
$f : \mathbb{R} \rightarrow \mathbb{R}$ defined by $f(x) = -x^2, x \in \mathbb{R}. f(x) \in (-\infty, 0]$	 <p>Fig. 1.47(b)</p>

The equations of motion of a particle travelling under the influence of gravity is a quadratic function of time. These functions are not one – one. (Why?)

**1.10.4 Cubic Function**

A function  $f : \mathbb{R} \rightarrow \mathbb{R}$  defined by  $f(x) = ax^3 + bx^2 + cx + d, (a \neq 0)$  is called a **cubic function**.

The graph of  $f(x) = x^3$  is shown in Fig.1.48.

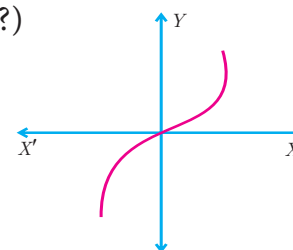

Fig. 1.48

**1.10.5 Reciprocal Function**

A function  $f : \mathbb{R} - \{0\} \rightarrow \mathbb{R}$  defined by  $f(x) = \frac{1}{x}$  is called a **reciprocal function** (Fig.1.49).

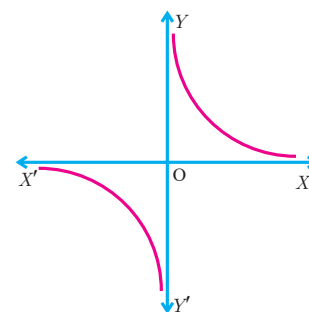

Fig. 1.49



### 1.10.6 Constant Function

A function  $f : \mathbb{R} \rightarrow \mathbb{R}$  defined by  $f(x) = c, \forall x \in \mathbb{R}$  is called a **constant function** (Fig.1.50).

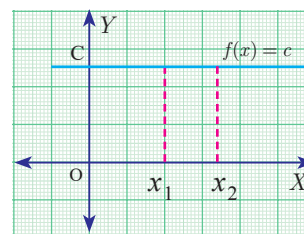

Fig. 1.50



#### Progress Check

1. Is a constant function a linear function?
2. Is quadratic function a one - one function?
3. Is cubic function a one - one function?
4. Is the reciprocal function a bijection?
5. If  $f : A \rightarrow B$  is a constant function, then the range of  $f$  will have \_\_\_\_\_ elements.



#### Exercise 1.5

1. Using the functions  $f$  and  $g$  given below, find  $f \circ g$  and  $g \circ f$ . Check whether  $f \circ g = g \circ f$ .
  - (i)  $f(x) = x - 6, g(x) = x^2$
  - (ii)  $f(x) = \frac{2}{x}, g(x) = 2x^2 - 1$
  - (iii)  $f(x) = \frac{x+6}{3}, g(x) = 3 - x$
  - (iv)  $f(x) = 3 + x, g(x) = x - 4$
  - (v)  $f(x) = 4x^2 - 1, g(x) = 1 + x$
2. Find the value of  $k$ , such that  $f \circ g = g \circ f$ 
  - (i)  $f(x) = 3x + 2, g(x) = 6x - k$
  - (ii)  $f(x) = 2x - k, g(x) = 4x + 5$
3. If  $f(x) = 2x - 1, g(x) = \frac{x+1}{2}$ , show that  $f \circ g = g \circ f = x$
4. If  $f(x) = x^2 - 1, g(x) = x - 2$  find  $a$ , if  $g \circ f(a) = 1$ .
5. Let  $A, B, C \subseteq \mathbb{N}$  and a function  $f : A \rightarrow B$  be defined by  $f(x) = 2x + 1$  and  $g : B \rightarrow C$  be defined by  $g(x) = x^2$ . Find the range of  $f \circ g$  and  $g \circ f$ .
6. Let  $f(x) = x^2 - 1$ . Find (i)  $f \circ f$  (ii)  $f \circ f \circ f$
7. If  $f : \mathbb{R} \rightarrow \mathbb{R}$  and  $g : \mathbb{R} \rightarrow \mathbb{R}$  are defined by  $f(x) = x^5$  and  $g(x) = x^4$  then check if  $f, g$  are one-one and  $f \circ g$  is one-one?

8. Consider the functions  $f(x)$ ,  $g(x)$ ,  $h(x)$  as given below. Show that  $(f \circ g) \circ h = f \circ (g \circ h)$  in each case.
- (i)  $f(x) = x - 1$ ,  $g(x) = 3x + 1$  and  $h(x) = x^2$
- (ii)  $f(x) = x^2$ ,  $g(x) = 2x$  and  $h(x) = x + 4$
- (iii)  $f(x) = x - 4$ ,  $g(x) = x^2$  and  $h(x) = 3x - 5$
9. Let  $f = \{(-1, 3), (0, -1), (2, -9)\}$  be a linear function from  $\mathbb{Z}$  into  $\mathbb{Z}$ . Find  $f(x)$ .
10. In electrical circuit theory, a circuit  $C(t)$  is called a linear circuit if it satisfies the superposition principle given by  $C(at_1 + bt_2) = aC(t_1) + bC(t_2)$ , where  $a, b$  are constants. Show that the circuit  $C(t) = 3t$  is linear.



### Exercise 1.6



VB1ELV

### Multiple choice questions

- If  $n(A \times B) = 6$  and  $A = \{1, 3\}$  then  $n(B)$  is  
 (A) 1 (B) 2 (C) 3 (D) 6
- $A = \{a, b, p\}$ ,  $B = \{2, 3\}$ ,  $C = \{p, q, r, s\}$  then  $n[(A \cup C) \times B]$  is  
 (A) 8 (B) 20 (C) 12 (D) 16
- If  $A = \{1, 2\}$ ,  $B = \{1, 2, 3, 4\}$ ,  $C = \{5, 6\}$  and  $D = \{5, 6, 7, 8\}$  then state which of the following statement is true.  
 (A)  $(A \times C) \subset (B \times D)$  (B)  $(B \times D) \subset (A \times C)$   
 (C)  $(A \times B) \subset (A \times D)$  (D)  $(D \times A) \subset (B \times A)$
- If there are 1024 relations from a set  $A = \{1, 2, 3, 4, 5\}$  to a set  $B$ , then the number of elements in  $B$  is  
 (A) 3 (B) 2 (C) 4 (D) 8
- The range of the relation  $R = \{(x, x^2) \mid x \text{ is a prime number less than } 13\}$  is  
 (A)  $\{2, 3, 5, 7\}$  (B)  $\{2, 3, 5, 7, 11\}$   
 (C)  $\{4, 9, 25, 49, 121\}$  (D)  $\{1, 4, 9, 25, 49, 121\}$
- If the ordered pairs  $(a + 2, 4)$  and  $(5, 2a + b)$  are equal then  $(a, b)$  is  
 (A)  $(2, -2)$  (B)  $(5, 1)$  (C)  $(2, 3)$  (D)  $(3, -2)$
- Let  $n(A) = m$  and  $n(B) = n$  then the total number of non-empty relations that can be defined from  $A$  to  $B$  is  
 (A)  $m^n$  (B)  $n^m$  (C)  $2^{mn} - 1$  (D)  $2^{mn}$
- If  $\{(a, 8), (6, b)\}$  represents an identity function, then the value of  $a$  and  $b$  are respectively  
 (A)  $(8, 6)$  (B)  $(8, 8)$  (C)  $(6, 8)$  (D)  $(6, 6)$

9. Let  $A = \{1, 2, 3, 4\}$  and  $B = \{4, 8, 9, 10\}$ . A function  $f : A \rightarrow B$  given by  $f = \{(1, 4), (2, 8), (3, 9), (4, 10)\}$  is a
- (A) Many-one function (B) Identity function  
(C) One-to-one function (D) Into function
10. If  $f(x) = 2x^2$  and  $g(x) = \frac{1}{3x}$ , then  $f \circ g$  is
- (A)  $\frac{3}{2x^2}$  (B)  $\frac{2}{3x^2}$  (C)  $\frac{2}{9x^2}$  (D)  $\frac{1}{6x^2}$
11. If  $f : A \rightarrow B$  is a bijective function and if  $n(B) = 7$ , then  $n(A)$  is equal to
- (A) 7 (B) 49 (C) 1 (D) 14
12. Let  $f$  and  $g$  be two functions given by
- $f = \{(0, 1), (2, 0), (3, -4), (4, 2), (5, 7)\}$
- $g = \{(0, 2), (1, 0), (2, 4), (-4, 2), (7, 0)\}$  then the range of  $f \circ g$  is
- (A)  $\{0, 2, 3, 4, 5\}$  (B)  $\{-4, 1, 0, 2, 7\}$  (C)  $\{1, 2, 3, 4, 5\}$  (D)  $\{0, 1, 2\}$
13. Let  $f(x) = \sqrt{1 + x^2}$  then
- (A)  $f(xy) = f(x) \cdot f(y)$  (B)  $f(xy) \geq f(x) \cdot f(y)$   
(C)  $f(xy) \leq f(x) \cdot f(y)$  (D) None of these
14. If  $g = \{(1, 1), (2, 3), (3, 5), (4, 7)\}$  is a function given by  $g(x) = \alpha x + \beta$  then the values of  $\alpha$  and  $\beta$  are
- (A)  $(-1, 2)$  (B)  $(2, -1)$  (C)  $(-1, -2)$  (D)  $(1, 2)$
15.  $f(x) = (x + 1)^3 - (x - 1)^3$  represents a function which is
- (A) linear (B) cubic (C) reciprocal (D) quadratic

### Unit Exercise - 1



- If the ordered pairs  $(x^2 - 3x, y^2 + 4y)$  and  $(-2, 5)$  are equal, then find  $x$  and  $y$ .
- The cartesian product  $A \times A$  has 9 elements among which  $(-1, 0)$  and  $(0, 1)$  are found. Find the set  $A$  and the remaining elements of  $A \times A$ .
- Given that  $f(x) = \begin{cases} \sqrt{x-1} & x \geq 1 \\ 4 & x < 1 \end{cases}$ . Find
  - $f(0)$
  - $f(3)$
  - $f(a + 1)$  in terms of  $a$ . (Given that  $a \geq 0$ )
- Let  $A = \{9, 10, 11, 12, 13, 14, 15, 16, 17\}$  and let  $f : A \rightarrow N$  be defined by  $f(n) =$  the highest prime factor of  $n \in A$ . Write  $f$  as a set of ordered pairs and find the range of  $f$ .

5. Find the domain of the function  $f(x) = \sqrt{1 + \sqrt{1 - \sqrt{1 - x^2}}}$
6. If  $f(x) = x^2$ ,  $g(x) = 3x$  and  $h(x) = x - 2$ , Prove that  $(f \circ g) \circ h = f \circ (g \circ h)$ .
7. Let  $A = \{1, 2\}$  and  $B = \{1, 2, 3, 4\}$ ,  $C = \{5, 6\}$  and  $D = \{5, 6, 7, 8\}$ . Verify whether  $A \times C$  is a subset of  $B \times D$ ?
8. If  $f(x) = \frac{x-1}{x+1}$ ,  $x \neq -1$  show that  $f(f(x)) = -\frac{1}{x}$ , provided  $x \neq 0$ .
9. The functions  $f$  and  $g$  are defined by  $f(x) = 6x + 8$ ;  $g(x) = \frac{x-2}{3}$
- (i) Calculate the value of  $gg\left(\frac{1}{2}\right)$
- (ii) Write an expression for  $gf(x)$  in its simplest form.
10. Write the domain of the following real functions
- (i)  $f(x) = \frac{2x+1}{x-9}$  (ii)  $p(x) = \frac{-5}{4x^2+1}$  (iii)  $g(x) = \sqrt{x-2}$  (iv)  $h(x) = x+6$

### Points to Remember

- The Cartesian Product of  $A$  with  $B$  is defined as  $A \times B = \{(a, b) \mid \text{for all } a \in A, b \in B\}$
- A relation  $R$  from  $A$  to  $B$  is always a subset of  $A \times B$ . That is  $R \subseteq A \times B$
- A relation  $R$  from  $X$  to  $Y$  is a function if for every  $x \in X$  there exists only one  $y \in Y$ .
- A function can be represented by
  - (i) an arrow diagram
  - (ii) a tabular form
  - (iii) a set of ordered pairs
  - (iv) a graphical form
- Some types of functions
  - (i) One-one function
  - (ii) Onto function
  - (iii) Many-one function
  - (iv) Into function
- Identity function  $f(x) = x$
- Reciprocal function  $f(x) = \frac{1}{x}$



- Constant function  $f(x) = c$
- Linear function  $f(x) = ax + b, a \neq 0$
- Quadratic function  $f(x) = ax^2 + bx + c, a \neq 0$
- Cubic function  $f(x) = ax^3 + bx^2 + cx + d, a \neq 0$
- For three non-empty sets  $A, B$  and  $C$ , if  $f: A \rightarrow B$  and  $g: B \rightarrow C$  are two functions, then the composition of  $f$  and  $g$  is a function  $g \circ f: A \rightarrow C$  will be defined as  $g \circ f(x) = g(f(x))$  for all  $x \in A$ .
- If  $f$  and  $g$  are any two functions, then in general,  $f \circ g \neq g \circ f$
- If  $f, g$  and  $h$  are any three functions, then  $f \circ (g \circ h) = (f \circ g) \circ h$

ICT CORNER



ICT 1.1

**Step 1:** Open the Browser type the URL Link given below (or) Scan the QR Code. GeoGebra work book named “Relations and Functions–X” will open. In the left side of the work book there are many activity related to Relations and Functions chapter. Select the work sheet “Functions Identification”

**Step 2:** In the given worksheet click on the check boxes corresponding to each function on left hand side. You can see the graph of respective function on Right hand side. Analyse each graph and then click “New Functions” and continue till you understand.

Step 1

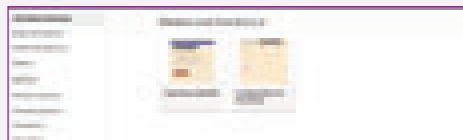

Step 2

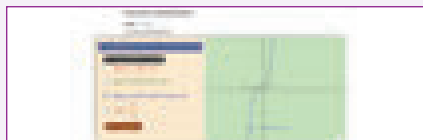

Expected results

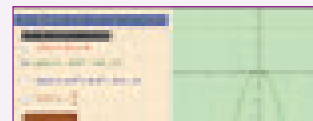

ICT 1.2

**Step 1:** Open the Browser type the URL Link given below (or) Scan the QR Code. GeoGebra work book named “Relations and Functions–X” will open. In the left side of the work book there are many activity related to Relations and Functions chapter. Select the work sheet “Composition of Functions”

**Step 2:** In the given worksheet click on the check boxes corresponding to each function on left hand side. You can see the graph of respective function on Right hand side. Analyse each graph and then click “New Functions” and continue till you understand.

Step 1

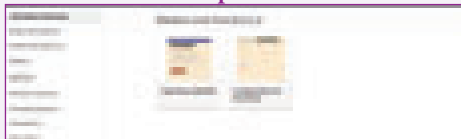

Step 2

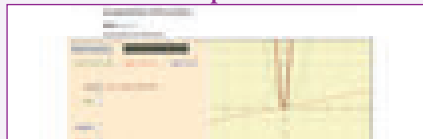

Expected results

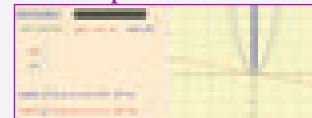

You can repeat the same steps for other activities

<https://www.geogebra.org/m/jfr2zzgy#chapter/356191>  
or Scan the QR Code.



## 2

## NUMBERS AND SEQUENCES

*"I know numbers are beautiful, if they aren't beautiful, nothing is"*  
- Paul Erdos

**Srinivasa Ramanujan** was an Indian mathematical genius who was born in Erode in a poor family. He was a child prodigy and made calculations at lightning speed. He produced thousands of precious formulae, jotting them on his three notebooks which are now preserved at the University of Madras. With the help of several notable men, he became the first research scholar in the mathematics department of University of Madras. Subsequently, he went to England and collaborated with G.H. Hardy for five years from 1914 to 1919.



**Srinivasa Ramanujan**  
(1887-1920)

He possessed great interest in observing the pattern of numbers and produced several new results in Analytic Number Theory. His mathematical ability was compared to Euler and Jacobi, the two great mathematicians of the past Era. Ramanujan wrote thirty important research papers and wrote seven research papers in collaboration with G.H. Hardy. He has produced 3972 formulas and theorems in very short span of 32 years lifetime. He was awarded B.A. degree for research in 1916 by Cambridge University which is equivalent to modern day Ph.D. Degree. For his contributions to number theory, he was made **Fellow of Royal Society** (F.R.S.) in 1918.

His works continue to delight mathematicians worldwide even today. Many surprising connections are made in the last few years of work made by Ramanujan nearly a century ago.



## Learning Outcomes

- To study the concept of Euclid's Division Lemma.
- To understand Euclid's Division Algorithm.
- To find the LCM and HCF using Euclid's Division Algorithm.
- To understand the Fundamental Theorem of Arithmetic.
- To understand the congruence modulo ' $n$ ', addition modulo ' $n$ ' and multiplication modulo ' $n$ '.
- To define sequence and to understand sequence as a function.
- To define an Arithmetic Progression (A.P.) and Geometric Progression (G.P.).
- To find the  $n^{\text{th}}$  term of an A.P. and its sum to  $n$  terms.
- To find the  $n^{\text{th}}$  term of a G.P. and its sum to  $n$  terms.
- To determine the sum of some finite series such as  $\sum n$ ,  $\sum n^2$ ,  $\sum n^3$ .



## 2.1 Introduction

The study of numbers has fascinated humans since several thousands of years. The discovery of Lebombo and Ishango bones which existed around 25000 years ago has confirmed the fact that humans made counting process for meeting various day to day needs. By making notches in the bones they carried out counting efficiently. Most consider that these bones were used as lunar calendar for knowing the phases of moon thereby understanding the seasons. Thus the bones were considered to be the ancient tools for counting. We have come a long way since this primitive counting method existed.

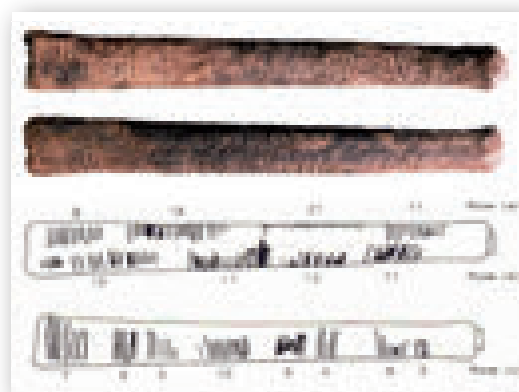

Number carvings in Ishango Bone  
Fig.2.1

It is very true that the patterns exhibited by numbers have fascinated almost all professional mathematicians' right from the time of Pythagoras to current time. We will be discussing significant concepts provided by Euclid and continue our journey of studying Modular Arithmetic and knowing about Sequences and Finite Series. These ideas are most fundamental to your progress in mathematics for upcoming classes. It is time for us to begin our journey to understand the most fascinating part of mathematics, namely, the study of numbers.

## 2.2 Euclid's Division Lemma

Euclid, one of the most important mathematicians wrote an important book named "Elements" in 13 volumes. The first six volumes were devoted to Geometry and for this reason, Euclid is called the "Father of Geometry". But in the next few volumes, he made fundamental contributions to understand the properties of numbers. One among them is the "Euclid's Division Lemma". This is a simplified version of the long division process that you were performing for division of numbers in earlier classes.

Let us now discuss Euclid's Lemma and its application through an Algorithm termed as "Euclid's Division Algorithm".

Lemma is an auxiliary result used for proving an important theorem. It is usually considered as a mini theorem.

### Theorem 1: Euclid's Division Lemma

Let  $a$  and  $b$  be any two positive integers. Then, there exist unique integers  $q$  and  $r$  such that  $a = bq + r$ ,  $0 \leq r < b$ .

**Note**



- The remainder is always less than the divisor.
- If  $r = 0$  then  $a = bq$  so  $b$  divides  $a$ .
- Conversely, if  $b$  divides  $a$  then  $a = bq$

**Example 2.1** We have 34 cakes. Each box can hold 5 cakes only. How many boxes we need to pack and how many cakes are unpacked?

**Solution** We see that 6 boxes are required to pack 30 cakes with 4 cakes left over. This distribution of cakes can be understood as follows:

34	=	5	×	6	+	4
Total number of cakes	=	Number of cakes in each box	×	Number of boxes	+	Number of cakes left over
↓		↓		↓		↓
(Dividend) $a$	=	(Divisor) $b$	×	(Quotient) $q$	+	(Remainder) $r$

### Note



- The above lemma is nothing but a restatement of the long division process, the integers  $q$  and  $r$  are called quotient and remainder respectively.
- When a positive integer is divided by 2 the remainder is either 0 or 1. So, any positive integer will be of the form  $2k, 2k+1$  for some integer  $k$ .

Euclid's Division Lemma can be generalised to any two integers.

### Generalised form of Euclid's division lemma

If  $a$  and  $b$  are ( $b \neq 0$ ) any two integers then there exist unique integers  $q$  and  $r$  such that  $a = bq + r$ , where  $0 \leq r < |b|$

**Example 2.2** Find the quotient and remainder when  $a$  is divided by  $b$  in the following cases (i)  $a = -12, b = 5$  (ii)  $a = 17, b = -3$  (iii)  $a = -19, b = -4$

### Solutions

(i)  $a = -12, b = 5$

By Euclid's division lemma

$$a = bq + r, \text{ where } 0 \leq r < |b|$$

$$-12 = 5 \times (-3) + 3 \quad 0 \leq r < |5|$$

Therefore, Quotient  $q = -3$ , Remainder  $r = 3$

(ii)  $a = 17, b = -3$

By Euclid's division lemma

$$a = bq + r, \text{ where } 0 \leq r < |b|$$

$$17 = (-3) \times (-5) + 2, \quad 0 \leq r < |-3|$$

Therefore Quotient  $q = -5$ ,

Remainder  $r = 2$

(iii)  $a = -19, b = -4$

By Euclid's division lemma

$$a = bq + r, \text{ where } 0 \leq r < |b|$$

$$-19 = (-4) \times (5) + 1, \quad 0 \leq r < |-4|$$

Therefore Quotient  $q = 5$ , Remainder  $r = 1$ .

### Thinking Corner



When a positive integer is divided by 3

1. What are the possible remainders?
2. In which form can it be written?



### Progress Check

Find  $q$  and  $r$  for the following pairs of integers  $a$  and  $b$  satisfying  $a = bq + r$ .

1.  $a = 13, b = 3$
2.  $a = 18, b = 4$
3.  $a = 21, b = -4$
4.  $a = -32, b = -12$
5.  $a = -31, b = 7$

**Example 2.3** Show that the square of an odd integer is of the form  $4q + 1$ , for some integer  $q$ .

**Solution** Let  $x$  be any odd integer. Since any odd integer is one more than an even integer, we have  $x = 2k + 1$ , for some integers  $k$ .

$$\begin{aligned}x^2 &= (2k + 1)^2 \\&= 4k^2 + 4k + 1 \\&= 4k(k + 1) + 1 \\&= 4q + 1, \text{ where } q = k(k + 1) \text{ is some integer.}\end{aligned}$$

## 2.3 Euclid's Division Algorithm

In the previous section, we have studied about Euclid's division lemma and its applications. We now study the concept Euclid's Division Algorithm. The word 'algorithm' comes from the name of 9<sup>th</sup> century Persian Mathematician Al-khwarizmi. An algorithm means a series of methodical step-by-step procedure of calculating successively on the results of earlier steps till the desired answer is obtained.

Euclid's division algorithm provides an easier way to compute the Highest Common Factor (HCF) of two given positive integers. Let us now prove the following theorem.

### Theorem 2

If  $a$  and  $b$  are positive integers such that  $a = bq + r$ , then every common divisor of  $a$  and  $b$  is a common divisor of  $b$  and  $r$  and vice-versa.

### Euclid's Division Algorithm

To find Highest Common Factor of two positive integers  $a$  and  $b$ , where  $a > b$

**Step 1:** Using Euclid's division lemma  $a = bq + r$ ;  $0 \leq r < b$ . where  $q$  is the quotient,  $r$  is the remainder. If  $r = 0$  then  $b$  is the Highest Common Factor of  $a$  and  $b$ .

**Step 2:** Otherwise applying Euclid's division lemma divide  $b$  by  $r$  to get  $b = rq_1 + r_1$ ,  $0 \leq r_1 < r$

**Step 3:** If  $r_1 = 0$  then  $r$  is the Highest common factor of  $a$  and  $b$ .

**Step 4:** Otherwise using Euclid's division lemma, repeat the process until we get the remainder zero. In that case, the corresponding divisor is the HCF of  $a$  and  $b$ .

#### Note



- The above algorithm will always produce remainder zero at some stage. Hence the algorithm should terminate.
- Euclid's Division Algorithm is a repeated application of Division Lemma until we get zero remainder.
- Highest Common Factor (HCF) of two positive numbers is denoted by  $(a, b)$ .
- Highest Common Factor (HCF) is also called as Greatest Common Divisor (GCD).



### Progress Check

1. Euclid's division algorithm is a repeated application of division lemma until we get remainder as \_\_\_\_\_.
2. The HCF of two equal positive integers  $k$ ,  $k$  is \_\_\_\_\_.

### Illustration 1

Using the above Algorithm, let us find HCF of two given positive integers. Let  $a = 273$  and  $b = 119$  be the two given positive integers such that  $a > b$ .

We start dividing 273 by 119 using Euclid's division lemma.

we get,  $273 = 119 \times 2 + 35 \quad \dots(1)$

The remainder is  $35 \neq 0$ .

Therefore, applying Euclid's Division Algorithm to the divisor 119 and remainder 35. we get,

$$119 = 35 \times 3 + 14 \quad \dots(2)$$

The remainder is  $14 \neq 0$ .

Applying Euclid's Division Algorithm to the divisor 35 and remainder 14.

we get,  $35 = 14 \times 2 + 7 \quad \dots(3)$

The remainder is  $7 \neq 0$ .

Applying Euclid's Division Algorithm to the divisor 14 and remainder 7.

we get,  $14 = 7 \times 2 + 0 \quad \dots(4)$

The remainder at this stage = 0.

The divisor at this stage = 7.

Therefore, Highest Common Factor of 273, 119 = 7.

**Example 2.4** If the Highest Common Factor of 210 and 55 is expressible in the form  $55x - 325$ , find  $x$ .

**Solution** Using Euclid's Division Algorithm, let us find the HCF of given numbers

$$210 = 55 \times 3 + 45$$

$$55 = 45 \times 1 + 10$$

$$45 = 10 \times 4 + 5$$

$$10 = 5 \times 2 + 0$$

The remainder is zero.

So, the last divisor 5 is the Highest Common Factor (HCF) of 210 and 55.

$\therefore$  HCF is expressible in the form  $55x - 325 = 5$

$$\Rightarrow 55x = 330$$

$$x = 6$$



**Example 2.5** Find the greatest number that will divide 445 and 572 leaving remainders 4 and 5 respectively.

**Solution** Since the remainders are 4, 5 respectively the required number is the HCF of the number  $445 - 4 = 441$ ,  $572 - 5 = 567$ .

Hence, we will determine the HCF of 441 and 567. Using Euclid's Division Algorithm, we have,

$$567 = 441 \times 1 + 126$$

$$441 = 126 \times 3 + 63$$

$$126 = 63 \times 2 + 0$$

Therefore,  $\text{HCF of } 441, 567 = 63$  and so the required number is 63.



### Activity 1

This activity helps you to find HCF of two positive numbers. We first observe the following instructions.

- (i) Construct a rectangle whose length and breadth are the given numbers.
- (ii) Try to fill the rectangle using small squares.
- (iii) Try with  $1 \times 1$  square; Try with  $2 \times 2$  square; Try with  $3 \times 3$  square and so on.
- (iv) The side of the largest square that can fill the whole rectangle without any gap will be HCF of the given numbers.
- (v) Find the HCF of (a) 12,20 (b) 16,24 (c) 11,9

### Theorem 3

If  $a$  and  $b$  are two positive integers with  $a > b$  then  $\text{G.C.D of } (a, b) = \text{GCD of } (a - b, b)$ .



### Activity 2

This is another activity to determine HCF of two given positive integers.

- (i) From the given numbers, subtract the smaller from the larger number.
- (ii) From the remaining numbers, subtract smaller from the larger.
- (iii) Repeat the subtraction process by subtracting smaller from the larger.
- (iv) Stop the process, when the numbers become equal.
- (v) The number representing equal numbers obtained in step (iv), will be the HCF of the given numbers.

Using this Activity, find the HCF of

- (i) 90,15 (ii) 80,25 (iii) 40,16 (iv) 23,12 (v) 93,13

### Highest Common Factor of three numbers

We can apply Euclid's Division Algorithm twice to find the Highest Common Factor (HCF) of three positive integers using the following procedure.

Let  $a, b, c$  be the given positive integers.

(i) Find HCF of  $a, b$ . Call it as  $d$

$$d = (a, b)$$

(ii) Find HCF of  $d$  and  $c$ .

This will be the HCF of the three given numbers  $a, b, c$

**Example 2.6** Find the HCF of 396, 504, 636.

**Solution** To find HCF of three given numbers, first we have to find HCF of the first two numbers.

To find HCF of 396 and 504

Using Euclid's division algorithm we get  $504 = 396 \times 1 + 108$

The remainder is  $108 \neq 0$

Again applying Euclid's division algorithm  $396 = 108 \times 3 + 72$

The remainder is  $72 \neq 0$ ,

Again applying Euclid's division algorithm  $108 = 72 \times 1 + 36$

The remainder is  $36 \neq 0$ ,

Again applying Euclid's division algorithm  $72 = 36 \times 2 + 0$

Here the remainder is zero. Therefore HCF of 396, 504 = 36.

To find the HCF of 636 and 36.

Using Euclid's division algorithm we get  $636 = 36 \times 17 + 24$

The remainder is  $24 \neq 0$

Again applying Euclid's division algorithm  $36 = 24 \times 1 + 12$

The remainder is  $12 \neq 0$

Again applying Euclid's division algorithm  $24 = 12 \times 2 + 0$

Here the remainder is zero. Therefore HCF of 636, 36 = 12

Therefore Highest Common Factor of 396, 504 and 636 is 12.

Two positive integers are said to be relatively prime or co prime if their Highest Common Factor is 1.



#### Exercise 2.1

1. Find all positive integers, when divided by 3 leaves remainder 2.
2. A man has 532 flower pots. He wants to arrange them in rows such that each row contains 21 flower pots. Find the number of completed rows and how many flower pots are left over.



3. Prove that the product of two consecutive positive integers is divisible by 2.
4. When the positive integers  $a$ ,  $b$  and  $c$  are divided by 13, the respective remainders are 9, 7 and 10. Show that  $a+b+c$  is divisible by 13.
5. Prove that square of any integer leaves the remainder either 0 or 1 when divided by 4.
6. Use Euclid's Division Algorithm to find the Highest Common Factor (HCF) of
  - (i) 340 and 412
  - (ii) 867 and 255
  - (iii) 10224 and 9648
  - (iv) 84, 90 and 120
7. Find the largest number which divides 1230 and 1926 leaving remainder 12 in each case.
8. If  $d$  is the Highest Common Factor of 32 and 60, find  $x$  and  $y$  satisfying  $d = 32x + 60y$ .
9. A positive integer when divided by 88 gives the remainder 61. What will be the remainder when the same number is divided by 11?
10. Prove that two consecutive positive integers are always coprime.

## 2.4 Fundamental Theorem of Arithmetic

Let us consider the following conversation between a Teacher and students.

**Teacher** : Factorise the number 240.

**Malar** :  $24 \times 10$

**Raghu** :  $8 \times 30$

**Iniya** :  $12 \times 20$

**Kumar** :  $15 \times 16$

**Malar** : Whose answer is correct Sir?

**Teacher** : All the answers are correct.

**Raghu** : How sir?

**Teacher** : Split each of the factors into product of prime numbers.

**Malar** :  $2 \times 2 \times 2 \times 3 \times 2 \times 5$

**Raghu** :  $2 \times 2 \times 2 \times 2 \times 3 \times 5$

**Iniya** :  $2 \times 2 \times 3 \times 2 \times 2 \times 5$

**Kumar** :  $3 \times 5 \times 2 \times 2 \times 2 \times 2$

**Teacher** : Good! Now, count the number of 2's, 3's and 5's.

**Malar** : I got four 2's, one 3 and one 5.

**Raghu** : I got four 2's, one 3 and one 5.

**Iniya** : I also got the same numbers too.

**Kumar** : Me too sir.

**Malar** : All of us got four 2's, one 3 and one 5. This is very surprising to us.

**Teacher** : Yes, It should be. Once any number is factorized up to a product of prime numbers, everyone should get the same collection of prime numbers.

This concept leads us to the following important theorem.

**Theorem 4 (Fundamental Theorem of Arithmetic) (without proof)**

“Every positive integer (except the number 1) can be represented in exactly one way apart from rearrangement as a product of one or more primes.”

The fundamental theorem asserts that every composite number can be decomposed as a product of prime numbers and that the decomposition is unique. In the sense that there is one and only way to express the decomposition as product of primes.

In general, we conclude that given a composite number N, we decompose it uniquely in the form

$N = p_1^{q_1} \times p_2^{q_2} \times p_3^{q_3} \times \dots \times p_n^{q_n}$  where  $p_1, p_2, p_3, \dots, p_n$  are primes and  $q_1, q_2, q_3, \dots, q_n$  are natural numbers.

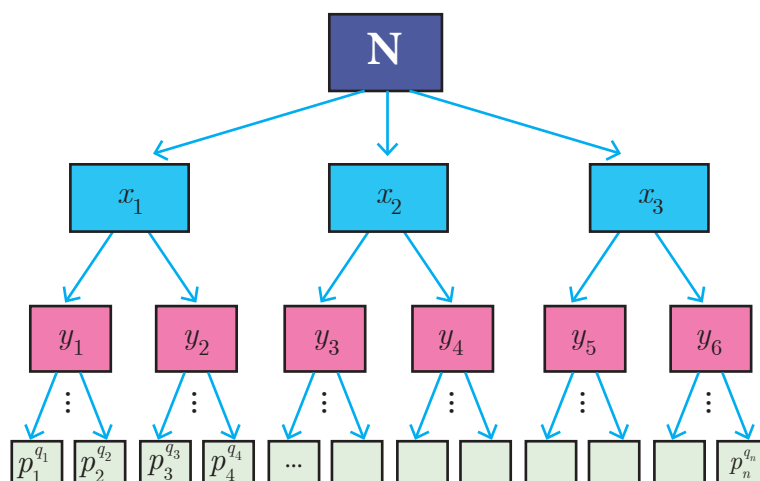

Fig.2.2

First, we try to factorize N into its factors. If all the factors are themselves primes then we can stop. Otherwise, we try to further split the factors which are not prime. Continue the process till we get only prime numbers.

Thinking Corner

Is 1 a prime number?

**Illustration**

For example, if we try to factorize 32760 we get

$$32760 = 2 \times 2 \times 2 \times 3 \times 3 \times 5 \times 7 \times 13$$

$$= 2^3 \times 3^2 \times 5^1 \times 7^1 \times 13^1$$

Thus, in whatever way we try to factorize 32760, we should finally get three 2's, two 3's, one 5, one 7 and one 13.

The fact that “Every composite number can be written uniquely as the product of power of primes” is called **Fundamental Theorem of Arithmetic**.



**Progress Check**

1. Every natural number except \_\_\_\_\_ can be expressed as \_\_\_\_\_.
2. In how many ways a composite number can be written as product of power of primes?
3. The number of divisors of any prime number is \_\_\_\_\_.

**2.4.1 Significance of the Fundamental Theorem of Arithmetic**

The fundamental theorem about natural numbers except 1, that we have stated above has several applications, both in Mathematics and in other fields. The theorem is vastly important in Mathematics, since it highlights the fact that prime numbers are the ‘Building Blocks’ for all the positive integers. Thus, prime numbers can be compared to atoms making up a molecule.





1. If a prime number  $p$  divides  $ab$  then either  $p$  divides  $a$  or  $p$  divides  $b$ , that is  $p$  divides at least one of them.
2. If a composite number  $n$  divides  $ab$ , then  $n$  neither divide  $a$  nor  $b$ .  
For example, 6 divides  $4 \times 3$  but 6 neither divide 4 nor 3.

**Example 2.7** In the given factorisation, find the numbers  $m$  and  $n$ .

**Solution** Value of the first box from bottom =  $5 \times 2 = 10$   
 Value of  $n = 5 \times 10 = 50$   
 Value of the second box from bottom =  $3 \times 50 = 150$   
 Value of  $m = 2 \times 150 = 300$

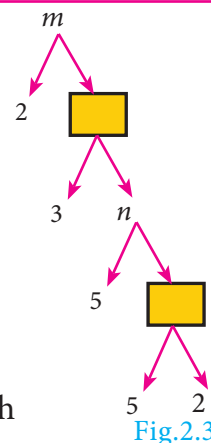

Thus, the required numbers are  $m = 300$ ,  $n = 50$

**Example 2.8** Can the number  $6^n$ ,  $n$  being a natural number end with the digit 5? Give reason for your answer.

**Solution** Since  $6^n = (2 \times 3)^n = 2^n \times 3^n$ ,  
 2 is a factor of  $6^n$ . So,  $6^n$  is always even.  
 But any number whose last digit is 5 is always odd.  
 Hence,  $6^n$  cannot end with the digit 5.



**Progress Check**

1. Let  $m$  divides  $n$ . Then GCD and LCM of  $m, n$  are \_\_\_\_ and \_\_\_\_.
2. The HCF of numbers of the form  $2^m$  and  $3^n$  is \_\_\_\_.

**Example 2.9** Is  $7 \times 5 \times 3 \times 2 + 3$  a composite number? Justify your answer.

**Solution** Yes, the given number is a composite number, because

$$7 \times 5 \times 3 \times 2 + 3 = 3 \times (7 \times 5 \times 2 + 1) = 3 \times 71$$

Since the given number can be factorized in terms of two primes, it is a composite number.

**Example 2.10** 'a' and 'b' are two positive integers such that  $a^b \times b^a = 800$ . Find 'a' and 'b'.

**Solution** The number 800 can be factorized as

$$800 = 2 \times 2 \times 2 \times 2 \times 2 \times 5 \times 5 = 2^5 \times 5^2$$

Hence,  $a^b \times b^a = 2^5 \times 5^2$

This implies that  $a = 2$  and  $b = 5$  (or)  $a = 5$  and  $b = 2$ .

**Thinking Corner**



Can you think of positive integers  $a, b$  such that  $a^b = b^a$ ?



**Activity 3**

Can you find the 4-digit pin number 'pqrs' of an ATM card such that  $p^2 \times q^1 \times r^4 \times s^3 = 3,15,000$ ?

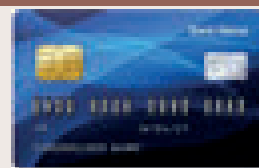

Fig.2.4



### Exercise 2.2

1. For what values of natural number  $n$ ,  $4^n$  can end with the digit 6?
2. If  $m, n$  are natural numbers, for what values of  $m$ , does  $2^n \times 5^m$  ends in 5?
3. Find the HCF of 252525 and 363636.
4. If  $13824 = 2^a \times 3^b$  then find  $a$  and  $b$ .
5. If  $p_1^{x_1} \times p_2^{x_2} \times p_3^{x_3} \times p_4^{x_4} = 113400$  where  $p_1, p_2, p_3, p_4$  are primes in ascending order and  $x_1, x_2, x_3, x_4$  are integers, find the value of  $p_1, p_2, p_3, p_4$  and  $x_1, x_2, x_3, x_4$ .
6. Find the LCM and HCF of 408 and 170 by applying the fundamental theorem of arithmetic.
7. Find the greatest number consisting of 6 digits which is exactly divisible by 24, 15, 36?
8. What is the smallest number that when divided by three numbers such as 35, 56 and 91 leaves remainder 7 in each case?
9. Find the least number that is divisible by the first ten natural numbers.

## 2.5 Modular Arithmetic

In a clock, we use the numbers 1 to 12 to represent the time period of 24 hours. How is it possible to represent the 24 hours of a day in a 12 number format? We use 1, 2, 3, 4, 5, 6, 7, 8, 9, 10, 11, 12 and after 12, we use 1 instead of 13 and 2 instead of 14 and so on. That is after 12 we again start from 1, 2, 3,... In this system the numbers wrap around 1 to 12. This type of wrapping around after hitting some value is called **Modular Arithmetic**.



Fig.2.5

In Mathematics, modular arithmetic is a system of arithmetic for integers where numbers wrap around a certain value. Unlike normal arithmetic, Modular Arithmetic process cyclically. The ideas of Modular arithmetic was developed by great German mathematician **Carl Friedrich Gauss**, who is hailed as the “**Prince of mathematicians**”.



### Examples

1. The day and night change repeatedly.
2. The days of a week occur cyclically from Sunday to Saturday.
3. The life cycle of a plant.
4. The seasons of a year change cyclically. (Summer, Autumn, Winter, Spring)
5. The railway and aeroplane timings also work cyclically. The railway time starts at 00:00 and continue. After reaching 23:59, the next minute will become 00:00 instead of 24:00.

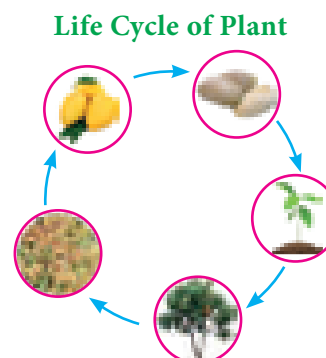

Fig.2.6

### 2.5.1 Congruence Modulo

Two integers  $a$  and  $b$  are congruence modulo  $n$  if they differ by an integer multiple of  $n$ . That  $a - b = kn$  for some integer  $k$ . This can also be written as  $a \equiv b \pmod{n}$ .

Here the number  $n$  is called modulus. In other words,  $a \equiv b \pmod{n}$  means  $a - b$  is divisible by  $n$ .

For example,  $61 \equiv 5 \pmod{7}$  because  $61 - 5 = 56$  is divisible by 7.

**Note**

- When a positive integer is divided by  $n$ , then the possible remainders are  $0, 1, 2, \dots, n - 1$ .
- Thus, when we work with modulo  $n$ , we replace all the numbers by their remainders upon division by  $n$ , given by  $0, 1, 2, 3, \dots, n - 1$ .

Two illustrations are provided to understand modulo concept more clearly.

#### Illustration 1

To find  $8 \pmod{4}$

With a modulus of 4 (since the possible remainders are 0, 1, 2, 3) we make a diagram like a clock with numbers 0, 1, 2, 3. We start at 0 and go through 8 numbers in a clockwise sequence 1, 2, 3, 0, 1, 2, 3, 0. After doing so cyclically, we end at 0.

Therefore,  $8 \equiv 0 \pmod{4}$

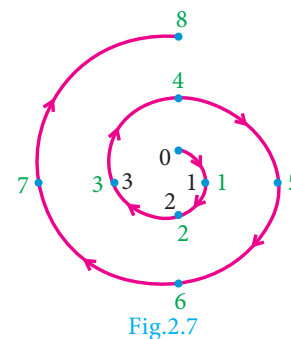

#### Illustration 2

To find  $-5 \pmod{3}$

With a modulus of 3 (since the possible remainders are 0, 1, 2) we make a diagram like a clock with numbers 0, 1, 2.

We start at 0 and go through 5 numbers in anti-clockwise sequence 2, 1, 0, 2, 1. After doing so cyclically, we end at 1.

Therefore,  $-5 \equiv 1 \pmod{3}$

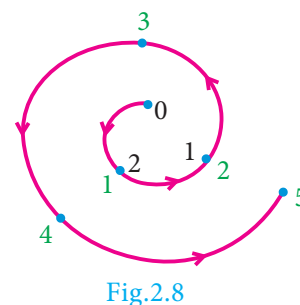

### 2.5.2 Connecting Euclid's Division lemma and Modular Arithmetic

Let  $m$  and  $n$  be integers, where  $m$  is positive. Then by Euclid's division lemma, we can write  $n = mq + r$  where  $0 \leq r < m$  and  $q$  is an integer. Instead of writing  $n = mq + r$  we can use the congruence notation in the following way.

We say that  $n$  is congruent to  $r$  modulo  $m$ , if  $n = mq + r$  for some integer  $q$ .

$$\begin{aligned} n &= mq + r \\ n - r &= mq \\ n - r &\equiv 0 \pmod{m} \\ n &\equiv r \pmod{m} \end{aligned}$$

Thus the equation  $n = mq + r$  through Euclid's Division lemma can also be written as  $n \equiv r \pmod{m}$ .



#### Progress Check

1. Two integers  $a$  and  $b$  are congruent modulo  $n$  if \_\_\_\_\_.
2. The set of all positive integers which leave remainder 5 when divided by 7 are \_\_\_\_\_.

**Note**



Two integers  $a$  and  $b$  are congruent modulo  $m$ , written as  $a \equiv b \pmod{m}$ , if they leave the same remainder when divided by  $m$ .

**Thinking Corner**



How many integers exist which leave a remainder of 2 when divided by 3?

**2.5.3 Modulo operations**

Similar to basic arithmetic operations like addition, subtraction and multiplication performed on numbers we can think of performing same operations in modulo arithmetic. The following theorem provides the information of doing this.

**Theorem 5**

$a, b, c$  and  $d$  are integers and  $m$  is a positive integer such that if  $a \equiv b \pmod{m}$  and  $c \equiv d \pmod{m}$  then

- (i)  $(a + c) \equiv (b + d) \pmod{m}$       (ii)  $(a - c) \equiv (b - d) \pmod{m}$
- (iii)  $(a \times c) \equiv (b \times d) \pmod{m}$

**Illustration 3**

If  $17 \equiv 4 \pmod{13}$  and  $42 \equiv 3 \pmod{13}$  then from theorem 5,

(i)  $17 + 42 \equiv 4 + 3 \pmod{13}$

$59 \equiv 7 \pmod{13}$

(ii)  $17 - 42 \equiv 4 - 3 \pmod{13}$

$-25 \equiv 1 \pmod{13}$

(iii)  $17 \times 42 \equiv 4 \times 3 \pmod{13}$

$714 \equiv 12 \pmod{13}$

**Theorem 6**

If  $a \equiv b \pmod{m}$  then

- (i)  $ac \equiv bc \pmod{m}$       (ii)  $a \pm c \equiv b \pm c \pmod{m}$  for any integer  $c$



**Progress Check**

1. The positive values of  $k$  such that  $(k-3) \equiv 5 \pmod{11}$  are \_\_\_\_\_.
2. If  $59 \equiv 3 \pmod{7}$ ,  $46 \equiv 4 \pmod{7}$  then  $105 \equiv$  \_\_\_\_\_  $\pmod{7}$ ,  
 $13 \equiv$  \_\_\_\_\_  $\pmod{7}$ ,  $413 \equiv$  \_\_\_\_\_  $\pmod{7}$ ,  $368 \equiv$  \_\_\_\_\_  $\pmod{7}$ .
3. The remainder when  $7 \times 13 \times 19 \times 23 \times 29 \times 31$  is divided by 6 is \_\_\_\_\_.

**Example 2.11** Find the remainders when 70004 and 778 is divided by 7.

**Solution** Since 70000 is divisible by 7

$$70000 \equiv 0 \pmod{7}$$

$$70000 + 4 \equiv 0 + 4 \pmod{7}$$

$$70004 \equiv 4 \pmod{7}$$

Therefore, the remainder when 70004 is divided by 7 is 4.

$\therefore$  777 is divisible by 7

$$777 \equiv 0 \pmod{7}$$

$$777 + 1 \equiv 0 + 1 \pmod{7}$$

$$778 \equiv 1 \pmod{7}$$

Therefore, the remainder when 778 is divided by 7 is 1.

**Example 2.12** Determine the value of  $d$  such that  $15 \equiv 3 \pmod{d}$ .

**Solution**  $15 \equiv 3 \pmod{d}$  means  $15 - 3 = kd$ , for some integer  $k$ .

$$12 = kd.$$

$\Rightarrow d$  divides 12.

The divisors of 12 are 1,2,3,4,6,12. But  $d$  should be larger than 3 and so the possible values for  $d$  are 4,6,12.

**Example 2.13** Find the least positive value of  $x$  such that

$$(i) \quad 67 + x \equiv 1 \pmod{4} \quad (ii) \quad 98 \equiv (x + 4) \pmod{5}$$

**Solution** (i)  $67 + x \equiv 1 \pmod{4}$

$$67 + x - 1 = 4n, \text{ for some integer } n$$

$$66 + x = 4n$$

$66 + x$  is a multiple of 4.

Therefore, the least positive value of  $x$  must be 2, since 68 is the nearest multiple of 4 more than 66.

$$(ii) \quad 98 \equiv (x + 4) \pmod{5}$$

$$98 - (x + 4) = 5n, \text{ for some integer } n.$$

$$94 - x = 5n$$

$94 - x$  is a multiple of 5.

Therefore, the least positive value of  $x$  must be 4

$\therefore 94 - 4 = 90$  is the nearest multiple of 5 less than 94.

**Note**

While solving congruent equations, we get infinitely many solutions compared to finite number of solutions in solving a polynomial equation in Algebra.

**Example 2.14** Solve  $8x \equiv 1 \pmod{11}$

**Solution**  $8x \equiv 1 \pmod{11}$  can be written as  $8x - 1 = 11k$ , for some integer  $k$ .

$$x = \frac{11k + 1}{8}$$

When we put  $k = 5, 13, 21, 29, \dots$  then  $11k+1$  is divisible by 8.

$$x = \frac{11 \times 5 + 1}{8} = 7$$

$$x = \frac{11 \times 13 + 1}{8} = 18$$

$\therefore$  The solutions are 7, 18, 29, 40, ...

**Example 2.15** Compute  $x$ , such that  $10^4 \equiv x \pmod{19}$

**Solution**

$$10^2 = 100 \equiv 5 \pmod{19}$$

$$10^4 = (10^2)^2 \equiv 5^2 \pmod{19}$$

$$10^4 \equiv 25 \pmod{19}$$

$$10^4 \equiv 6 \pmod{19} \quad (\because 25 \equiv 6 \pmod{19})$$

$$\therefore x = 6.$$

**Example 2.16** Find the number of integer solutions of  $3x \equiv 1 \pmod{15}$ .

**Solution**

$3x \equiv 1 \pmod{15}$  can be written as

$3x - 1 = 15k$  for some integer  $k$

$$3x = 15k + 1$$

$$x = \frac{15k + 1}{3}$$

$$x = 5k + \frac{1}{3}$$

$\therefore 5k$  is an integer,  $5k + \frac{1}{3}$  cannot be an integer.

So there is no integer solution.

**Example 2.17** A man starts his journey from Chennai to Delhi by train. He starts at 22.30 hours on Wednesday. If it takes 32 hours of travelling time and assuming that the train is not late, when will he reach Delhi?





**Solution** Starting time 22.30, Travelling time 32 hours. Here we use modulo 24.

The reaching time is

$$\begin{aligned} 22.30 + 32 \pmod{24} &\equiv 54.30 \pmod{24} \\ &\equiv 6.30 \pmod{24} \quad (\because 32 = (1 \times 24) + 8) \\ &\qquad\qquad\qquad \text{Thursday Friday)} \end{aligned}$$

Thus, he will reach Delhi on Friday at 6.30 hours.

**Example 2.18** Kala and Vani are friends. Kala says, “Today is my birthday” and she asks Vani, “When will you celebrate your birthday?” Vani replies, “Today is Monday and I celebrated my birthday 75 days ago”. Find the day when Vani celebrated her birthday.

**Solution** Let us associate the numbers 0, 1, 2, 3, 4, 5, 6 to represent the weekdays from Sunday to Saturday respectively.

Vani says today is Monday. So the number for Monday is 1. Since Vani’s birthday was 75 days ago, we have to subtract 75 from 1 and take the modulo 7, since a week contain 7 days.

$$\begin{aligned} -74 \pmod{7} &\equiv -4 \pmod{7} \equiv 7-4 \pmod{7} \equiv 3 \pmod{7} \\ &\quad (\because -74 - 3 = -77 \text{ is divisible by } 7) \end{aligned}$$

Thus,  $1 - 75 \equiv 3 \pmod{7}$

The day for the number 3 is Wednesday.

Therefore, Vani’s birthday must be on Wednesday.



**Exercise 2.3**

1. Find the least positive value of  $x$  such that
  - (i)  $71 \equiv x \pmod{8}$  (ii)  $78 + x \equiv 3 \pmod{5}$  (iii)  $89 \equiv (x + 3) \pmod{4}$
  - (iv)  $96 \equiv \frac{x}{7} \pmod{5}$  (v)  $5x \equiv 4 \pmod{6}$
2. If  $x$  is congruent to 13 modulo 17 then  $7x - 3$  is congruent to which number modulo 17?
3. Solve  $5x \equiv 4 \pmod{6}$
4. Solve  $3x - 2 \equiv 0 \pmod{11}$
5. What is the time 100 hours after 7 a.m.?
6. What is the time 15 hours before 11 p.m.?
7. Today is Tuesday. My uncle will come after 45 days. In which day my uncle will be coming?
8. Prove that  $2^n + 6 \times 9^n$  is always divisible by 7 for any positive integer  $n$ .
9. Find the remainder when  $2^{81}$  is divided by 17.

10. The duration of flight travel from Chennai to London through British Airlines is approximately 11 hours. The airplane begins its journey on Sunday at 23:30 hours. If the time at Chennai is four and half hours ahead to that of London's time, then find the time at London, when will the flight lands at London Airport.

## 2.6 Sequences

Consider the following pictures.

There is some pattern or arrangement in these pictures. In the first picture, the first row contains one apple, the second row contains two apples and in the third row there are three

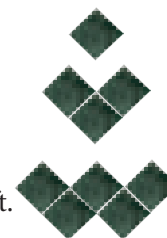
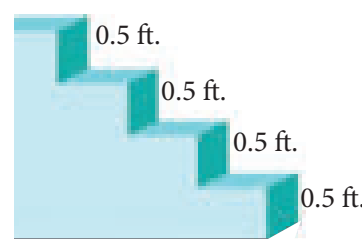
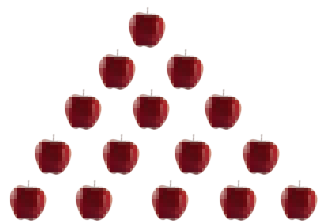

Fig.2.9

apples etc... The number of apples in each of the rows are 1, 2, 3, ...

In the second picture each step have 0.5 feet height. The total height of the steps from the base are 0.5 feet, 1 feet, 1.5 feet, ... In the third picture one square, 3 squares, 5 squares, ... These numbers belong to category called "Sequences".

### Definition

A **real valued sequence** is a function defined on the set of natural numbers and taking real values.

Each **element** in the sequence is called a **term** of the sequence. The element in the **first position** is called the **first term** of the sequence. The element in the **second position** is called **second term** of the sequence and so on.

If the  $n^{\text{th}}$  term is denoted by  $a_n$ , then  $a_1$  is the first term,  $a_2$  is the second term, and so on. A sequence can be written as  $a_1, a_2, a_3, \dots, a_n, \dots$

### Illustration

- 1, 3, 5, 7, ... is a sequence with general term  $a_n = 2n - 1$ . When we put  $n = 1, 2, 3, \dots$ , we get  $a_1 = 1, a_2 = 3, a_3 = 5, a_4 = 7, \dots$
- $\frac{1}{2}, \frac{1}{3}, \frac{1}{4}, \frac{1}{5}, \dots$  is a sequence with general term  $\frac{1}{n+1}$ . When we put  $n = 1, 2, 3, \dots$  we get  $a_1 = \frac{1}{2}, a_2 = \frac{1}{3}, a_3 = \frac{1}{4}, a_4 = \frac{1}{5}, \dots$

If the number of elements in a sequence is finite then it is called a **Finite sequence**. If the number of elements in a sequence is infinite then it is called an **Infinite sequence**.

## Sequence as a Function

A sequence can be considered as a function defined on the set of natural numbers  $\mathbb{N}$ . In particular, a sequence is a function  $f: \mathbb{N} \rightarrow \mathbb{R}$ , where  $\mathbb{R}$  is the set of all real numbers.

If the sequence is of the form  $a_1, a_2, a_3, \dots$  then we can associate the function to the sequence  $a_1, a_2, a_3, \dots$  by  $f(k) = a_k, k = 1, 2, 3, \dots$

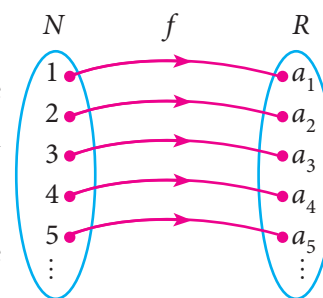

Fig 2.10



### Progress Check

- Fill in the blanks for the following sequences
  - 7, 13, 19, \_\_\_\_\_, ...
  - 2, \_\_\_\_\_, 10, 17, 26, ...
  - 1000, 100, 10, 1, \_\_\_\_\_, ...
- A sequence is a function defined on the set of \_\_\_\_\_.
- The  $n^{\text{th}}$  term of the sequence 0, 2, 6, 12, 20, ... can be expressed as \_\_\_\_\_.
- Say True or False
  - All sequences are functions
  - All functions are sequences.

**Example 2.19** Find the next three terms of the sequences

- $\frac{1}{2}, \frac{1}{6}, \frac{1}{10}, \frac{1}{14}, \dots$
- 5, 2, -1, -4, ...
- 1, 0.1, 0.01, ...

**Solution** (i)  $\frac{1}{2}, \frac{1}{6}, \frac{1}{10}, \frac{1}{14}, \dots$

$\xrightarrow{+4} \quad \xrightarrow{+4} \quad \xrightarrow{+4}$

In the above sequence the numerators are same and the denominator is increased by 4.

So the next three terms are  $a_5 = \frac{1}{14 + 4} = \frac{1}{18}$

$$a_6 = \frac{1}{18 + 4} = \frac{1}{22}$$

$$a_7 = \frac{1}{22 + 4} = \frac{1}{26}$$

(ii) 5, 2, -1, -4, ...

$\xrightarrow{-3} \quad \xrightarrow{-3} \quad \xrightarrow{-3}$

Here each term is decreased by 3. So the next three terms are -7, -10, -13.

(iii) 1, 0.1, 0.01, ...

$\xrightarrow{\sqrt{10}} \quad \xrightarrow{\sqrt{10}}$

### Note

Though all the sequences are functions, not all the functions are sequences.

Here each term is divided by 10. Hence, the next three terms are

$$a_4 = \frac{0.01}{10} = 0.001$$

$$a_5 = \frac{0.001}{10} = 0.0001$$

$$a_6 = \frac{0.0001}{10} = 0.00001$$

**Example 2.20** Find the general term for the following sequences

- (i) 3, 6, 9, ...    (ii)  $\frac{1}{2}, \frac{2}{3}, \frac{3}{4}, \dots$     (iii) 5, -25, 125, ...

**Solution** (i) 3, 6, 9, ...

Here the terms are multiples of 3. So the general term is

$$a_n = 3n,$$

- (ii)  $\frac{1}{2}, \frac{2}{3}, \frac{3}{4}, \dots$

$$a_1 = \frac{1}{2}; a_2 = \frac{2}{3}; a_3 = \frac{3}{4}$$

We see that the numerator of  $n^{\text{th}}$  term is  $n$ , and the denominator is one more than the numerator. Hence,  $a_n = \frac{n}{n+1}, n \in \mathbb{N}$

- (iii) 5, -25, 125, ...

The terms of the sequence have + and - sign alternatively and also they are in powers of 5.

So the general term  $a_n = (-1)^{n+1}5^n, n \in \mathbb{N}$

**Example 2.21** The general term of a sequence is defined as

$$a_n = \begin{cases} n(n+3); & n \in \mathbb{N} \text{ is odd} \\ n^2 + 1 & ; n \in \mathbb{N} \text{ is even} \end{cases}$$

Find the eleventh and eighteenth terms.

**Solution** To find  $a_{11}$ , since 11 is odd, we put  $n = 11$  in  $a_n = n(n+3)$

$$\text{Thus, the eleventh term } a_{11} = 11(11+3) = 154.$$

To find  $a_{18}$ , since 18 is even, we put  $n = 18$  in  $a_n = n^2 + 1$

$$\text{Thus, the eighteenth term } a_{18} = 18^2 + 1 = 325.$$

**Example 2.22** Find the first five terms of the following sequence.

$$a_1 = 1, a_2 = 1, a_n = \frac{a_{n-1}}{a_{n-2} + 3}; n \geq 3, n \in \mathbb{N}$$

**Solution** The first two terms of this sequence are given by  $a_1 = 1, a_2 = 1$ . The third term  $a_3$  depends on the first and second terms.

$$a_3 = \frac{a_{3-1}}{a_{3-2} + 3} = \frac{a_2}{a_1 + 3} = \frac{1}{1 + 3} = \frac{1}{4}$$

Similarly the fourth term  $a_4$  depends upon  $a_2$  and  $a_3$ .

$$a_4 = \frac{a_{4-1}}{a_{4-2} + 3} = \frac{a_3}{a_2 + 3} = \frac{\frac{1}{4}}{1 + 3} = \frac{\frac{1}{4}}{4} = \frac{1}{4} \times \frac{1}{4} = \frac{1}{16}$$

In the same way, the fifth term  $a_5$  can be calculated as

$$a_5 = \frac{a_{5-1}}{a_{5-2} + 3} = \frac{a_4}{a_3 + 3} = \frac{\frac{1}{16}}{\frac{1}{4} + 3} = \frac{1}{16} \times \frac{4}{13} = \frac{1}{52}$$

Therefore, the first five terms of the sequence are  $1, 1, \frac{1}{4}, \frac{1}{16}$  and  $\frac{1}{52}$



### Exercise 2.4

- Find the next three terms of the following sequence.
  - $8, 24, 72, \dots$
  - $5, 1, -3, \dots$
  - $\frac{1}{4}, \frac{2}{9}, \frac{3}{16}, \dots$
- Find the first four terms of the sequences whose  $n^{\text{th}}$  terms are given by
  - $a_n = n^3 - 2$
  - $a_n = (-1)^{n+1}n(n+1)$
  - $a_n = 2n^2 - 6$
- Find the  $n^{\text{th}}$  term of the following sequences
  - $2, 5, 10, 17, \dots$
  - $0, \frac{1}{2}, \frac{2}{3}, \dots$
  - $3, 8, 13, 18, \dots$
- Find the indicated terms of the sequences whose  $n^{\text{th}}$  terms are given by
  - $a_n = \frac{5n}{n+2}$ ;  $a_6$  and  $a_{13}$
  - $a_n = -(n^2 - 4)$ ;  $a_4$  and  $a_{11}$
- Find  $a_8$  and  $a_{15}$  whose  $n^{\text{th}}$  term is  $a_n = \begin{cases} \frac{n^2 - 1}{n + 3} & ; n \text{ is even, } n \in \mathbb{N} \\ \frac{n^2}{2n + 1} & ; n \text{ is odd, } n \in \mathbb{N} \end{cases}$
- If  $a_1 = 1, a_2 = 1$  and  $a_n = 2a_{n-1} + a_{n-2}, n \geq 3, n \in \mathbb{N}$ , then find the first six terms of the sequence.

## 2.7 Arithmetic Progression

Let us begin with the following two illustrations.

### Illustration 1

Make the following figures using match sticks

- How many match sticks are required for each figure? 3, 5, 7 and 9.

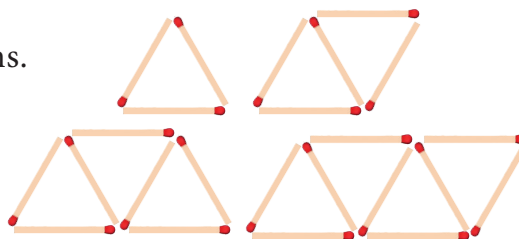

Fig.2.11

- Can we find the difference between the successive numbers?

$$5 - 3 = 7 - 5 = 9 - 7 = 2$$

Therefore, the difference between successive numbers is always 2.

### Illustration 2

A man got a job whose initial monthly salary is fixed at ₹10,000 with an annual increment of ₹2000. His salary during 1<sup>st</sup>, 2<sup>nd</sup> and 3<sup>rd</sup> years will be ₹10000, ₹12000 and ₹14000 respectively.

If we now calculate the difference of the salaries for the successive years, we get  $12000 - 10000 = 2000$ ;  $14000 - 12000 = 2000$ . Thus the difference between the successive numbers (salaries) is always 2000.

Did you observe the common property behind these two illustrations? In these two examples, the difference between successive terms always remains constant. Moreover, each term is obtained by adding a fixed number (2 and 2000 in illustrations 1 and 2 presented above) to the preceding term except the **first term**. This fixed number which is a constant for the differences between successive terms is called the **“common difference”**.

#### Definition

Let  $a$  and  $d$  be real numbers. Then the numbers of the form  $a, a + d, a + 2d, a + 3d, a + 4d, \dots$  is said to form **Arithmetic Progression** denoted by A.P. The number ‘ $a$ ’ is called the **first term** and ‘ $d$ ’ is called the **common difference**.

Simply, an Arithmetic Progression is a sequence whose successive terms differ by a constant number. Thus, for example, the set of even positive integers 2, 4, 6, 8, 10, 12, ... is an A.P. whose first term is  $a = 2$  and common difference is also  $d = 2$  since  $4 - 2 = 2$ ,  $6 - 4 = 2$ ,  $8 - 6 = 2$ , ...

Most of common real-life situations often produce numbers in A.P.

#### Note

- The difference between any two consecutive terms of an A.P. is always constant. That constant value is called the common difference.
- If there are finite numbers of terms in an A.P. then it is called Finite Arithmetic Progression. If there are infinitely many terms in an A.P. then it is called Infinite Arithmetic Progression.

### 2.7.1 Terms and Common Difference of an A.P.

1. The terms of an A.P. can be written as

$$t_1 = a = a + (1 - 1)d, \quad t_2 = a + d = a + (2 - 1)d,$$

$$t_3 = a + 2d = a + (3 - 1)d, \quad t_4 = a + 3d = a + (4 - 1)d, \dots$$

In general, the  $n^{\text{th}}$  term denoted by  $t_n$  can be written as  $t_n = a + (n - 1)d$ .

In an AP,  $n^{\text{th}}$  term is,  $t_n = a + (n - 1)d$ , here,  $a$  is the first term,  $d$  is the common difference.



2. In general to find the common difference of an A.P. we should subtract first term from the second term, second from the third and so on.

For example,  $t_1 = a, t_2 = a + d$

$$\therefore t_2 - t_1 = (a + d) - a = d$$

Similarly,  $t_2 = a + d, t_3 = a + 2d, \dots$

$$\therefore t_3 - t_2 = (a + 2d) - (a + d) = d$$

In general,  $d = t_2 - t_1 = t_3 - t_2 = t_4 - t_3 = \dots$

$$d = t_n - t_{n-1} \text{ for } n = 2, 3, 4, \dots$$



### Progress Check

- The difference between any two consecutive terms of an A.P. is \_\_\_\_\_.
- If  $a$  and  $d$  are the first term and common difference of an A.P. then the  $8^{\text{th}}$  term is \_\_\_\_\_.
- If  $t_n$  is the  $n^{\text{th}}$  term of an A.P., then  $t_{2n} - t_n$  is \_\_\_\_\_.

Let us try to find the common differences of the following A.P.'s

- (i) 1, 4, 7, 10, ...

$$d = 4 - 1 = 7 - 4 = 10 - 7 = \dots = 3$$

- (ii) 6, 2, -2, -6, ...

$$d = 2 - 6 = -2 - 2 = -6 - (-2) = \dots = -4$$

The common difference of an A.P. can be positive, negative or zero.



### Thinking Corner

If  $t_n$  is the  $n^{\text{th}}$  term of an A.P. then the value of  $t_{n+1} - t_{n-1}$  is \_\_\_\_\_.

**Example 2.23** Check whether the following sequences are in A.P. or not?

- (i)  $x + 2, 2x + 3, 3x + 4, \dots$  (ii) 2, 4, 8, 16, ... (iii)  $3\sqrt{2}, 5\sqrt{2}, 7\sqrt{2}, 9\sqrt{2}, \dots$

**Solution** To check that the given sequence is in A.P., it is enough to check if the differences between the consecutive terms are equal or not.

(i)  $t_2 - t_1 = (2x + 3) - (x + 2) = x + 1$

$$t_3 - t_2 = (3x + 4) - (2x + 3) = x + 1$$

$$t_2 - t_1 = t_3 - t_2$$

Thus, the differences between consecutive terms are equal.

Hence the sequence  $x + 2, 2x + 3, 3x + 4, \dots$  is in A.P.

(ii)  $t_2 - t_1 = 4 - 2 = 2$

$$t_3 - t_2 = 8 - 4 = 4$$

$$t_2 - t_1 \neq t_3 - t_2$$

Thus, the differences between consecutive terms are not equal. Hence the terms of the sequence 2, 4, 8, 16, ... are not in A.P.

$$\begin{aligned} \text{(iii) } t_2 - t_1 &= 5\sqrt{2} - 3\sqrt{2} = 2\sqrt{2} \\ t_3 - t_2 &= 7\sqrt{2} - 5\sqrt{2} = 2\sqrt{2} \\ t_4 - t_3 &= 9\sqrt{2} - 7\sqrt{2} = 2\sqrt{2} \end{aligned}$$

Thus, the differences between consecutive terms are equal. Hence the terms of the sequence  $3\sqrt{2}, 5\sqrt{2}, 7\sqrt{2}, 9\sqrt{2}, \dots$  are in A.P.

**Example 2.24** Write an A.P. whose first term is 20 and common difference is 8.

**Solution** First term =  $a = 20$ ; common difference =  $d = 8$

Arithmetic Progression is  $a, a + d, a + 2d, a + 3d, \dots$

In this case, we get  $20, 20 + 8, 20 + 2(8), 20 + 3(8), \dots$

So, the required A.P. is  $20, 28, 36, 44, \dots$

**Note**



An Arithmetic progression having a common difference of zero is called a constant arithmetic progression.



#### Activity 4

There are five boxes here. You have to pick one number from each box and form five Arithmetic Progressions.

8	6	14	1	26	3.5	20	11	32	8.5
-8	40	-14	-11	-3	70	-11	-2	-2	100
12	85	-5	2	7	55	-3	70	17	100

**Example 2.25** Find the  $15^{\text{th}}$ ,  $24^{\text{th}}$  and  $n^{\text{th}}$  term (general term) of an A.P. given by  $3, 15, 27, 39, \dots$

**Solution** We have, first term =  $a = 3$  and common difference =  $d = 15 - 3 = 12$ .

We know that  $n^{\text{th}}$  term (general term) of an A.P. with first term  $a$  and common difference  $d$  is given by  $t_n = a + (n - 1)d$

$$t_{15} = a + (15 - 1)d = a + 14d = 3 + 14(12) = 171$$

(Here  $a = 3$  and  $d = 12$ )

$$t_{24} = a + (24 - 1)d = a + 23d = 3 + 23(12) = 279$$

The  $n^{\text{th}}$  (general term) term is given by  $t_n = a + (n - 1)d$

Thus,

$$t_n = 3 + (n - 1)12$$

$$t_n = 12n - 9$$





**Note**

In a finite A.P. whose first term is  $a$  and last term  $l$ , then the number of terms in the A.P. is

$$\text{given by } l = a + (n - 1)d \Rightarrow n = \left( \frac{l - a}{d} \right) + 1$$

**Example 2.26** Find the number of terms in the A.P. 3, 6, 9, 12, ..., 111.

**Solution**

First term  $a = 3$ ; common difference  
 $d = 6 - 3 = 3$ ; last term  $l = 111$

$$\begin{aligned} \text{We know that, } n &= \left( \frac{l - a}{d} \right) + 1 \\ n &= \left( \frac{111 - 3}{3} \right) + 1 = 37 \end{aligned}$$

Thus the A.P. contain 37 terms.

**Progress Check**

1. The common difference of a constant A.P. is \_\_\_\_\_.
2. If  $a$  and  $l$  are first and last terms of an A.P. then the number of terms is \_\_\_\_\_.

**Example 2.27** Determine the general term of an A.P. whose 7<sup>th</sup> term is  $-1$  and 16<sup>th</sup> term is 17.

**Solution** Let the A.P. be  $t_1, t_2, t_3, t_4, \dots$

It is given that  $t_7 = -1$  and  $t_{16} = 17$

$$a + (7 - 1)d = -1 \text{ and } a + (16 - 1)d = 17$$

$$a + 6d = -1 \quad \dots(1)$$

$$a + 15d = 17 \quad \dots(2)$$

Subtracting equation (1) from equation (2), we get  $9d = 18 \Rightarrow d = 2$

Putting  $d = 2$  in equation (1), we get  $a + 12 = -1 \therefore a = -13$

Hence, general term  $t_n = a + (n - 1)d$

$$= -13 + (n - 1) \times 2 = 2n - 15$$

**Example 2.28** If  $l^{\text{th}}$ ,  $m^{\text{th}}$  and  $n^{\text{th}}$  terms of an A.P. are  $x$ ,  $y$ ,  $z$  respectively, then show that

$$(i) \ x(m - n) + y(n - l) + z(l - m) = 0 \quad (ii) \ (x - y)n + (y - z)l + (z - x)m = 0$$

**Solution** (i) Let  $a$  be the first term and  $d$  be the common difference. It is given that

$$t_l = x, t_m = y, t_n = z$$

Using the general term formula

$$a + (l - 1)d = x \quad \dots(1)$$

$$a + (m - 1)d = y \quad \dots(2)$$

$$a + (n - 1)d = z \quad \dots(3)$$

$$\begin{aligned}
 & \text{We have, } x(m-n) + y(n-l) + z(l-m) \\
 &= a[(m-n) + (n-l) + (l-m)] + d[(m-n)(l-1) + (n-l)(m-1) + (l-m)(n-1)] \\
 &= a[0] + d[lm - ln - m + n + mn - lm - n + l + ln - mn - l + m] \\
 &= a(0) + d(0) = 0
 \end{aligned}$$

(ii) On subtracting equation (2) from equation (1), equation (3) from equation (2) and equation (1) from equation (3), we get

$$\begin{aligned}
 x - y &= (l - m)d \\
 y - z &= (m - n)d \\
 z - x &= (n - l)d \\
 (x - y)n + (y - z)l + (z - x)m &= [(l - m)n + (m - n)l + (n - l)m]d \\
 &= [ln - mn + lm - nl + nm - lm]d = 0
 \end{aligned}$$

### Note



In an Arithmetic Progression

- If every term is added or subtracted by a constant, then the resulting sequence is also an A.P.
- If every term is multiplied or divided by a non-zero number, then the resulting sequence is also an A.P.
- If the sum of three consecutive terms of an A.P. is given, then they can be taken as  $a - d$ ,  $a$  and  $a + d$ . Here the common difference is  $d$ .
- If the sum of four consecutive terms of an A.P. is given then, they can be taken as  $a - 3d$ ,  $a - d$ ,  $a + d$  and  $a + 3d$ . Here common difference is  $2d$ .

**Example 2.29** In an A.P., sum of four consecutive terms is 28 and the sum of their squares is 276. Find the four numbers.

**Solution** Let us take the four terms in the form  $(a - 3d)$ ,  $(a - d)$ ,  $(a + d)$  and  $(a + 3d)$ .

Since, sum of the four terms is 28,

$$a - 3d + a - d + a + d + a + 3d = 28$$

$$4a = 28 \Rightarrow a = 7$$

Similarly, since sum of their squares is 276,

$$(a - 3d)^2 + (a - d)^2 + (a + d)^2 + (a + 3d)^2 = 276.$$

$$a^2 - 6ad + 9d^2 + a^2 - 2ad + d^2 + a^2 + 2ad + d^2 + a^2 + 6ad + 9d^2 = 276$$

$$4a^2 + 20d^2 = 276 \Rightarrow 4(7)^2 + 20d^2 = 276.$$

$$d^2 = 4 \Rightarrow d = \pm\sqrt{4} \text{ then, } d = \pm 2$$

If  $d = 2$  then the four numbers are  $7 - 3(2)$ ,  $7 - 2$ ,  $7 + 2$ ,  $7 + 3(2)$

That is the four numbers are 1, 5, 9 and 13.

If  $a = 7$ ,  $d = -2$  then the four numbers are 13, 9, 5 and 1

Therefore, the four consecutive terms of the A.P. are 1, 5, 9 and 13.

### Condition for three numbers to be in A.P.

If  $a, b, c$  are in A.P. then  $a = a$ ,  $b = a + d$ ,  $c = a + 2d$

$$\text{so } a + c = 2a + 2d = 2(a + d) = 2b$$

$$\text{Thus, } 2b = a + c$$

Similarly, if  $2b = a + c$ , then  $b - a = c - b$  so  $a, b, c$  are in A.P.

Thus three non-zero numbers  $a, b, c$  are in A.P. if and only if  $2b = a + c$

**Example 2.30** A mother divides ₹207 into three parts such that the amount are in A.P. and gives it to her three children. The product of the two least amounts that the children had ₹4623. Find the amount received by each child.

**Solution** Let the amount received by the three children be in the form of A.P. is given by

$a - d, a, a + d$ . Since, sum of the amount is ₹207, we have

$$(a - d) + a + (a + d) = 207$$

$$3a = 207 \Rightarrow a = 69$$

It is given that product of the two least amounts is 4623.

$$(a - d)a = 4623$$

$$(69 - d)69 = 4623$$

$$d = 2$$

Therefore, amount given by the mother to her three children are

₹(69-2), ₹69, ₹(69+2). That is, ₹67, ₹69 and ₹71.



### Progress Check

- If every term of an A.P. is multiplied by 3, then the common difference of the new A.P. is \_\_\_\_\_.
- Three numbers  $a, b$  and  $c$  will be in A.P. if and only if \_\_\_\_\_.



### Exercise 2.5

- Check whether the following sequences are in A.P.

(i)  $a - 3, a - 5, a - 7, \dots$       (ii)  $\frac{1}{2}, \frac{1}{3}, \frac{1}{4}, \frac{1}{5}, \dots$       (iii) 9, 13, 17, 21, 25,...

(iv)  $\frac{-1}{3}, 0, \frac{1}{3}, \frac{2}{3}, \dots$       (v) 1, -1, 1, -1, 1, -1, ...

- First term  $a$  and common difference  $d$  are given below. Find the corresponding A.P.

(i)  $a = 5, d = 6$       (ii)  $a = 7, d = -5$       (iii)  $a = \frac{3}{4}, d = \frac{1}{2}$

3. Find the first term and common difference of the Arithmetic Progressions whose  $n^{\text{th}}$  terms are given below
  - (i)  $t_n = -3 + 2n$
  - (ii)  $t_n = 4 - 7n$
4. Find the 19<sup>th</sup> term of an A.P.  $-11, -15, -19, \dots$
5. Which term of an A.P.  $16, 11, 6, 1, \dots$  is  $-54$ ?
6. Find the middle term(s) of an A.P.  $9, 15, 21, 27, \dots, 183$ .
7. If nine times ninth term is equal to the fifteen times fifteenth term, show that six times twenty fourth term is zero.
8. If  $3 + k, 18 - k, 5k + 1$  are in A.P. then find  $k$ .
9. Find  $x, y$  and  $z$ , given that the numbers  $x, 10, y, 24, z$  are in A.P.
10. In a theatre, there are 20 seats in the front row and 30 rows were allotted. Each successive row contains two additional seats than its front row. How many seats are there in the last row?
11. The sum of three consecutive terms that are in A.P. is 27 and their product is 288. Find the three terms.
12. The ratio of 6<sup>th</sup> and 8<sup>th</sup> term of an A.P. is 7:9. Find the ratio of 9<sup>th</sup> term to 13<sup>th</sup> term.
13. In a winter season let us take the temperature of Ooty from Monday to Friday to be in A.P. The sum of temperatures from Monday to Wednesday is  $0^\circ \text{C}$  and the sum of the temperatures from Wednesday to Friday is  $18^\circ \text{C}$ . Find the temperature on each of the five days.
14. Priya earned ₹15,000 in the first month. Thereafter her salary increased by ₹1500 per year. Her expenses are ₹13,000 during the first year and the expenses increases by ₹900 per year. How long will it take for her to save ₹20,000 per month.

## 2.8 Series

The sum of the terms of a sequence is called **series**. Let  $a_1, a_2, a_3, \dots, a_n, \dots$  be the sequence of real numbers. Then the real number  $a_1 + a_2 + a_3 + \dots$  is defined as the series of real numbers.

If a series has finite number of terms then it is called a **Finite series**. If a series has infinite number of terms then it is called an **Infinite series**. Let us focus our attention only on studying finite series.

### 2.8.1 Sum to $n$ terms of an A.P.

A series whose terms are in Arithmetic progression is called **Arithmetic series**.

Let  $a, a + d, a + 2d, a + 3d, \dots$  be the Arithmetic Progression.

The sum of first  $n$  terms of a Arithmetic Progression denoted by  $S_n$  is given by,

$$S_n = a + (a + d) + (a + 2d) + \dots + (a + (n - 1)d) \quad \dots(1)$$

Rewriting the above in reverse order

$$S_n = (a + (n - 1)d) + (a + (n - 2)d) + \dots + (a + d) + a \quad \dots(2)$$

Adding (1) and (2) we get,

$$\begin{aligned} 2S_n &= [a + a + (n - 1)d] + [a + d + a + (n - 2)d] + \dots + [a + (n - 2)d + (a + d)] + [a + (n - 1)d + a] \\ &= [2a + (n - 1)d] + [2a + (n - 1)d + \dots + [2a + (n - 1)d] \quad (n \text{ terms}) \end{aligned}$$

$$2S_n = n \times [2a + (n - 1)d] \quad \Rightarrow \quad S_n = \frac{n}{2} [2a + (n - 1)d]$$

#### Note

If the first term  $a$ , and the last term  $l$  ( $n^{\text{th}}$  term) are given then

$$S_n = \frac{n}{2} [2a + (n - 1)d] = \frac{n}{2} [a + a + (n - 1)d] \quad (\because l = a + (n - 1)d)$$

$$S_n = \frac{n}{2} [a + l].$$



#### Progress Check

1. The sum of terms of a sequence is called \_\_\_\_\_.
2. If a series have finite number of terms then it is called \_\_\_\_\_.
3. A series whose terms are in \_\_\_\_\_ is called Arithmetic series.
4. If the first and last terms of an A.P. are given, then the formula to find the sum is \_\_\_\_\_.

**Example 2.31** Find the sum of first 15 terms of the A. P.  $8, 7\frac{1}{4}, 6\frac{1}{2}, 5\frac{3}{4}, \dots$

**Solution** Here the first term  $a = 8$ , common difference  $d = 7\frac{1}{4} - 8 = -\frac{3}{4}$ ,

$$\text{Sum of first } n \text{ terms of an A.P. } S_n = \frac{n}{2} [2a + (n - 1)d]$$

$$S_{15} = \frac{15}{2} \left[ 2 \times 8 + (15 - 1) \left( -\frac{3}{4} \right) \right]$$

$$S_{15} = \frac{15}{2} \left[ 16 - \frac{21}{2} \right] = \frac{165}{4}$$

**Example 2.32** Find the sum of  $0.40 + 0.43 + 0.46 + \dots + 1$ .

**Solution** Here the value of  $n$  is not given. But the last term is given. From this, we can find the value of  $n$ .

Given,  $a = 0.40$  and  $l = 1$ , we find  $d = 0.43 - 0.40 = 0.03$ .

$$\begin{aligned}\text{Therefore, } n &= \left(\frac{l-a}{d}\right) + 1 \\ &= \left(\frac{1-0.40}{0.03}\right) + 1 = 21\end{aligned}$$

Sum of first  $n$  terms of an A.P.  $S_n = \frac{n}{2}[a + l]$

$$, n = 21. \quad \text{Therefore, } S_{21} = \frac{21}{2}[0.40 + 1] = 14.7$$

So, the sum of 21 terms of the given series is 14.7.

**Example 2.33** How many terms of the series  $1 + 5 + 9 + \dots$  must be taken so that their sum is 190?

**Solution** Here we have to find the value of  $n$ , such that  $S_n = 190$ .

First term  $a = 1$ , common difference  $d = 5 - 1 = 4$ .

Sum of first  $n$  terms of an A.P.

$$\begin{aligned}S_n &= \frac{n}{2}[2a + (n-1)d] = 190 \\ \frac{n}{2}[2 \times 1 + (n-1) \times 4] &= 190 \\ n[4n - 2] &= 380 \\ 2n^2 - n - 190 &= 0 \\ (n-10)(2n+19) &= 0\end{aligned}$$

But,  $n = 10$  as  $n = -\frac{19}{2}$  is impossible. Therefore,  $n = 10$ .

### Thinking Corner

The value of  $n$  must be positive. Why?



### Progress Check

State True or False. Justify it.

1. The  $n^{\text{th}}$  term of any A.P. is of the form  $pn+q$  where  $p$  and  $q$  are some constants.
2. The sum to  $n^{\text{th}}$  term of any A.P. is of the form  $pn^2+qn+r$  where  $p, q, r$  are some constants.

**Example 2.34** The  $13^{\text{th}}$  term of an A.P. is 3 and the sum of first 13 terms is 234. Find the common difference and the sum of first 21 terms.

**Solution** Given, the  $13^{\text{th}}$  term = 3 so,  $t_{13} = a + 12d = 3 \quad \dots(1)$

$$\begin{aligned} \text{Sum of first 13 terms} = 234 &\Rightarrow S_{13} = \frac{13}{2}[2a + 12d] = 234 \\ &2a + 12d = 36 \quad \dots(2) \end{aligned}$$

Solving (1) and (2) we get,  $a = 33$ ,  $d = \frac{-5}{2}$

Therefore, common difference is  $\frac{-5}{2}$ .

$$\text{Sum of first 21 terms } S_{21} = \frac{21}{2} \left[ 2 \times 33 + (21 - 1) \times \left( -\frac{5}{2} \right) \right] = \frac{21}{2} [66 - 50] = 168.$$

**Example 2.35** In an A.P. the sum of first  $n$  terms is  $\frac{5n^2}{2} + \frac{3n}{2}$ . Find the 17<sup>th</sup> term.

**Solution** The 17<sup>th</sup> term can be obtained by subtracting the sum of first 16 terms from the sum of first 17 terms

$$\begin{aligned} S_{17} &= \frac{5 \times (17)^2}{2} + \frac{3 \times 17}{2} = \frac{1445}{2} + \frac{51}{2} = 748 \\ S_{16} &= \frac{5 \times (16)^2}{2} + \frac{3 \times 16}{2} = \frac{1280}{2} + \frac{48}{2} = 664 \end{aligned}$$

$$\text{Now, } t_{17} = S_{17} - S_{16} = 748 - 664 = 84$$

**Example 2.36** Find the sum of all natural numbers between 300 and 600 which are divisible by 7.

**Solution** The natural numbers between 300 and 600 which are divisible by 7 are 301, 308, 315, ..., 595.

The sum of all natural numbers between 300 and 600 is  $301 + 308 + 315 + \dots + 595$ .

The terms of the above series are in A.P.

First term  $a = 301$ ; common difference  $d = 7$ ; Last term  $l = 595$ .

$$n = \left( \frac{l - a}{d} \right) + 1 = \left( \frac{595 - 301}{7} \right) + 1 = 43$$

$$\therefore S_n = \frac{n}{2}[a + l], \text{ we have } S_{43} = \frac{43}{2}[301 + 595] = 19264.$$

**Example 2.37** A mosaic is designed in the shape of an equilateral triangle, 12 ft on each side. Each tile in the mosaic is in the shape of an equilateral triangle of 12 inch side. The tiles are alternate in colour as shown in the figure. Find the number of tiles of each colour and total number of tiles in the mosaic.

**Solution** Since the mosaic is in the shape of an equilateral triangle of 12 feet, and the tile is in the shape of an equilateral triangle of 12 inch (1 feet), there will be 12 rows in the mosaic.

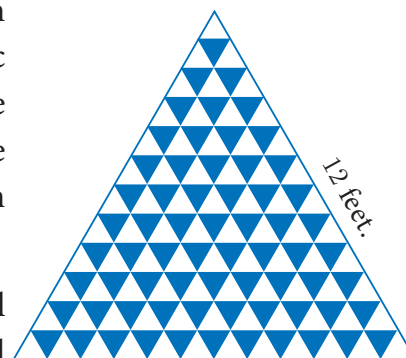

Fig.2.12

From the figure, it is clear that number of white tiles in each row are 1, 2, 3, 4, ..., 12 which clearly forms an Arithmetic Progression.

Similarly the number of blue tiles in each row are 0, 1, 2, 3, ..., 11 which is also an Arithmetic Progression.

$$\text{Number of white tiles} = 1 + 2 + 3 + \dots + 12 = \frac{12}{2}[1 + 12] = 78$$

$$\text{Number of blue tiles} = 0 + 1 + 2 + 3 + \dots + 11 = \frac{12}{2}[0 + 11] = 66$$

$$\text{The total number of tiles in the mosaic} = 78 + 66 = 144$$

**Example 2.38** The houses of a street are numbered from 1 to 49. Senthil's house is numbered such that the sum of numbers of the houses prior to Senthil's house is equal to the sum of numbers of the houses following Senthil's house. Find Senthil's house number?

**Solution** Let Senthil's house number be  $x$ .

$$\text{It is given that } 1 + 2 + 3 + \dots + (x - 1) = (x + 1) + (x + 2) + \dots + 49$$

$$1 + 2 + 3 + \dots + (x - 1) = [1 + 2 + 3 + \dots + 49] - [1 + 2 + 3 + \dots + x]$$

$$\frac{x-1}{2}[1 + (x-1)] = \frac{49}{2}[1 + 49] - \frac{x}{2}[1 + x]$$

$$\frac{x(x-1)}{2} = \frac{49 \times 50}{2} - \frac{x(x+1)}{2}$$

$$x^2 - x = 2450 - x^2 - x \Rightarrow 2x^2 = 2450$$

$$x^2 = 1225 \Rightarrow x = 35$$

Therefore, Senthil's house number is 35.

**Example 2.39** The sum of first  $n$ ,  $2n$  and  $3n$  terms of an A.P. are  $S_1$ ,  $S_2$  and  $S_3$  respectively. Prove that  $S_3 = 3(S_2 - S_1)$ .

**Solution** If  $S_1, S_2$  and  $S_3$  are sum of first  $n, 2n$  and  $3n$  terms of an A.P. respectively then

$$S_1 = \frac{n}{2}[2a + (n-1)d], \quad S_2 = \frac{2n}{2}[2a + (2n-1)d], \quad S_3 = \frac{3n}{2}[2a + (3n-1)d]$$

$$\text{Consider, } S_2 - S_1 = \frac{2n}{2}[2a + (2n-1)d] - \frac{n}{2}[2a + (n-1)d]$$

$$= \frac{n}{2}[[4a + 2(2n-1)d] - [2a + (n-1)d]]$$

$$S_2 - S_1 = \frac{n}{2} \times [2a + (3n-1)d]$$

$$3(S_2 - S_1) = \frac{3n}{2}[2a + (3n-1)d]$$

$$3(S_2 - S_1) = S_3$$

### Thinking Corner



1. What is the sum of first  $n$  odd natural numbers?
2. What is the sum of first  $n$  even natural numbers?





### Exercise 2.6

- Find the sum of the following
  - 3, 7, 11, ... up to 40 terms.
  - 102, 97, 92, ... up to 27 terms.
  - $6 + 13 + 20 + \dots + 97$
- How many consecutive odd integers beginning with 5 will sum to 480?
- Find the sum of first 28 terms of an A.P. whose  $n^{\text{th}}$  term is  $4n - 3$ .
- The sum of first  $n$  terms of a certain series is given as  $2n^2 - 3n$ . Show that the series is an A.P.
- The  $104^{\text{th}}$  term and  $4^{\text{th}}$  term of an A.P. are 125 and 0. Find the sum of first 35 terms.
- Find the sum of all odd positive integers less than 450.
- Find the sum of all natural numbers between 602 and 902 which are not divisible by 4.
- Raghu wish to buy a laptop. He can buy it by paying ₹40,000 cash or by giving it in 10 installments as ₹4800 in the first month, ₹4750 in the second month, ₹4700 in the third month and so on. If he pays the money in this fashion, find
  - total amount paid in 10 installments.
  - how much extra amount that he has to pay than the cost?
- A man repays a loan of ₹65,000 by paying ₹400 in the first month and then increasing the payment by ₹300 every month. How long will it take for him to clear the loan?
- A brick staircase has a total of 30 steps. The bottom step requires 100 bricks. Each successive step requires two bricks less than the previous step.
  - How many bricks are required for the top most step?
  - How many bricks are required to build the stair case?
- If  $S_1, S_2, S_3, \dots, S_m$  are the sums of  $n$  terms of  $m$  A.P.'s whose first terms are  $1, 2, 3, \dots, m$  and whose common differences are  $1, 3, 5, \dots, (2m - 1)$  respectively, then show that
 
$$S_1 + S_2 + S_3 + \dots + S_m = \frac{1}{2}mn(mn + 1).$$
- Find the sum  $\left[ \frac{a-b}{a+b} + \frac{3a-2b}{a+b} + \frac{5a-3b}{a+b} + \dots \text{to 12 terms} \right]$ .

## 2.9 Geometric Progression

In the diagram given in Fig.2.13,  $\triangle DEF$  is formed by joining the mid points of the sides  $AB$ ,  $BC$  and  $CA$  of  $\triangle ABC$ . Then the size of the triangle  $\triangle DEF$  is exactly one-fourth of the size of  $\triangle ABC$ . Similarly  $\triangle GHI$  is also one-fourth of  $\triangle DEF$  and so on. In general, the successive areas are one-fourth of the previous areas.



The area of these triangles are

$$\Delta ABC, \frac{1}{4} \Delta ABC, \frac{1}{4} \times \frac{1}{4} \Delta ABC, \dots$$

$$\text{That is, } \Delta ABC, \frac{1}{4} \Delta ABC, \frac{1}{16} \Delta ABC, \dots$$

In this case, we see that beginning with  $\Delta ABC$ , we see that the successive triangles are formed whose areas are precisely one-fourth the area of the previous triangle. So, each term is obtained by multiplying  $\frac{1}{4}$  to the previous term.

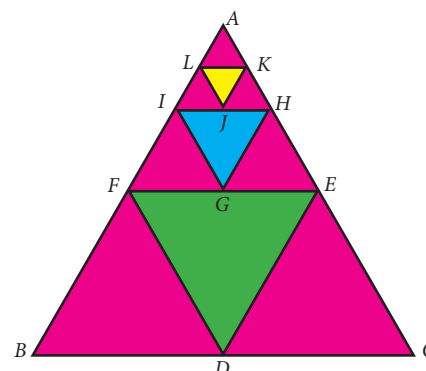

Fig.2.13

As another case, let us consider that a viral disease is spreading in a way such that at any stage two new persons get affected from an affected person. At first stage, one person is affected, at second stage two persons are affected and is spreading to four persons and so on. Then, number of persons affected at each stage are 1, 2, 4, 8, ... where except the first term, each term is precisely twice the previous term.

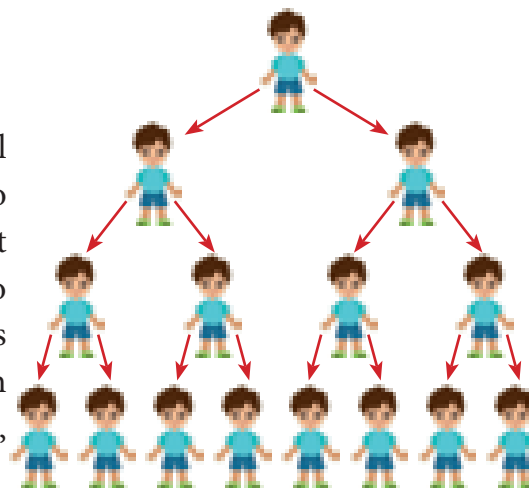

Fig.2.14

From the above examples, it is clear that each term is got by multiplying a fixed number to the preceding number.

This idea leads us to the concept of **Geometric Progression**.

### Definition

A Geometric Progression is a sequence in which each term is obtained by **multiplying** a fixed **non-zero number** to the preceding term except the first term. The fixed number is called **common ratio**. The common ratio is usually denoted by  $r$ .

### 2.9.1 General form of Geometric Progression

Let  $a$  and  $r \neq 0$  be real numbers. Then the numbers of the form  $a, ar, ar^2, \dots, ar^{n-1}, \dots$  is called a **Geometric Progression**. The number ' $a$ ' is called the first term and number ' $r$ ' is called the common ratio.

We note that beginning with first term  $a$ , each term is obtained by multiplied with the common ratio ' $r$ ' to give  $ar, ar^2, ar^3, \dots$

### 2.9.2 General term of Geometric Progression

We try to find a formula for  $n^{\text{th}}$  term or general term of Geometric Progression (G.P.) whose terms are in the common ratio.



$a, ar, ar^2, \dots, ar^{n-1}, \dots$  where  $a$  is the first term and ' $r$ ' is the common ratio. Let  $t_n$  be the  $n^{\text{th}}$  term of the G.P.

$$\begin{aligned} \text{Then } t_1 &= a = a \times r^0 = a \times r^{1-1} \\ t_2 &= t_1 \times r = a \times r = a \times r^{2-1} \\ t_3 &= t_2 \times r = ar \times r = ar^2 = ar^{3-1} \\ &\vdots \\ t_n &= t_{n-1} \times r = ar^{n-2} \times r = ar^{n-2+1} = ar^{n-1} \end{aligned}$$

Thus, the general term or  $n^{\text{th}}$  term of a G.P. is  $t_n = ar^{n-1}$

### Note

If we consider the ratio of successive terms of the G.P. then we have

$$\frac{t_2}{t_1} = \frac{ar}{a} = r, \quad \frac{t_3}{t_2} = \frac{ar^2}{ar} = r, \quad \frac{t_4}{t_3} = \frac{ar^3}{ar^2} = r, \quad \frac{t_5}{t_4} = \frac{ar^4}{ar^3} = r, \dots$$

Thus, the ratio between any two consecutive terms of the Geometric Progression is always constant and that constant is the common ratio of the given Progression.



### Progress Check

- A G.P. is obtained by multiplying \_\_\_\_\_ to the preceding term.
- The ratio between any two consecutive terms of the G.P. is \_\_\_\_\_ and it is called \_\_\_\_\_.
- Fill in the blanks if the following are in G.P.
  - $\frac{1}{8}, \frac{3}{4}, \frac{9}{2}, \dots$
  - $7, \frac{7}{2}, \dots$
  - $\dots, 2\sqrt{2}, 4, \dots$

**Example 2.40** Which of the following sequences form a Geometric Progression?

- (i) 7, 14, 21, 28, ...    (ii)  $\frac{1}{2}, 1, 2, 4, \dots$     (iii) 5, 25, 50, 75, ...

**Solution** To check if a given sequence form a G.P. we have to see if the ratio between successive terms are equal.

- (i) 7, 14, 21, 28, ...

$$\frac{t_2}{t_1} = \frac{14}{7} = 2; \quad \frac{t_3}{t_2} = \frac{21}{14} = \frac{3}{2}; \quad \frac{t_4}{t_3} = \frac{28}{21} = \frac{4}{3}$$

Since the ratios between successive terms are not equal, the sequence 7, 14, 21, 28, ... is not a Geometric Progression.

- (ii)  $\frac{1}{2}, 1, 2, 4, \dots$

$$\frac{t_2}{t_1} = \frac{1}{\frac{1}{2}} = 2; \quad \frac{t_3}{t_2} = \frac{2}{1} = 2; \quad \frac{t_4}{t_3} = \frac{4}{2} = 2$$

Here the ratios between successive terms are equal. Therefore the sequence

$\frac{1}{2}, 1, 2, 4, \dots$  is a Geometric Progression with common ratio  $r = 2$ .

(iii) 5, 25, 50, 75,...

$$\frac{t_2}{t_1} = \frac{25}{5} = 5; \quad \frac{t_3}{t_2} = \frac{50}{25} = 2; \quad \frac{t_4}{t_3} = \frac{75}{50} = \frac{3}{2}$$

### Thinking Corner



Is the sequence  
 $2, 2^2, 2^{2^2}, 2^{2^{2^2}}, \dots$  is a G.P. ?

Since the ratios between successive terms are not equal, the sequence

5, 25, 50, 75, ... is not a Geometric Progression.

**Example 2.41** Find the geometric progression whose first term and common ratios are given by (i)  $a = -7, r = 6$  (ii)  $a = 256, r = 0.5$

**Solution** (i) The general form of Geometric progression is  $a, ar, ar^2, \dots$

$$a = -7, \quad ar = -7 \times 6 = -42, \quad ar^2 = -7 \times 6^2 = -252$$

Therefore the required Geometric Progression is  $-7, -42, -252, \dots$

(ii) The general form of Geometric progression is  $a, ar, ar^2, \dots$

$$a = 256, \quad ar = 256 \times 0.5 = 128, \quad ar^2 = 256 \times (0.5)^2 = 64$$

Therefore the required Geometric progression is  $256, 128, 64, \dots$



### Progress Check

1. If first term =  $a$ , common ratio =  $r$ , then find the value of  $t_9$  and  $t_{27}$ .
2. In a G.P. if  $t_1 = \frac{1}{5}$  and  $t_2 = \frac{1}{25}$  then the common ratio is \_\_\_\_\_.

**Example 2.42** Find the 8<sup>th</sup> term of the G.P. 9, 3, 1, ...

**Solution** To find the 8<sup>th</sup> term we have to use the  $n^{\text{th}}$  term formula  $t_n = ar^{n-1}$

$$\text{First term } a = 9, \quad \text{Common ratio } r = \frac{t_2}{t_1} = \frac{3}{9} = \frac{1}{3}$$

$$t_8 = 9 \times \left(\frac{1}{3}\right)^{8-1} = 9 \times \left(\frac{1}{3}\right)^7 = \frac{1}{243}$$

Therefore the 8<sup>th</sup> term of the G.P. is  $\frac{1}{243}$ .

**Example 2.43** In a Geometric progression, the 4<sup>th</sup> term is  $\frac{8}{9}$  and the 7<sup>th</sup> term is  $\frac{64}{243}$ . Find the Geometric Progression.

$$\text{4<sup>th</sup> term, } t_4 = \frac{8}{9} \Rightarrow ar^3 = \frac{8}{9} \quad \dots(1)$$

$$\text{7<sup>th</sup> term, } t_7 = \frac{64}{243} \Rightarrow ar^6 = \frac{64}{243} \quad \dots(2)$$

Dividing (2) by (1) we get,  $\frac{ar^6}{ar^3} = \frac{64}{\frac{243}{8}}$

$$r^3 = \frac{8}{27} \Rightarrow r = \frac{2}{3}$$

Substituting the value of  $r$  in (1), we get  $a \times \left(\frac{2}{3}\right)^3 = \frac{8}{9} \Rightarrow a = 3$

Therefore the Geometric Progression is  $a, ar, ar^2, \dots$  That is,  $3, 2, \frac{4}{3}, \dots$

### Note

- When the product of three consecutive terms of a G.P. are given, we can take the three terms as  $\frac{a}{r}, a, ar$ .
- When the products of four consecutive terms are given for a G.P. then we can take the four terms as  $\frac{a}{r^3}, \frac{a}{r}, ar, ar^3$ .
- When each term of a Geometric Progression is multiplied or divided by a non-zero constant then the resulting sequence is also a Geometric Progression.

**Example 2.44** The product of three consecutive terms of a Geometric Progression is 343 and their sum is  $\frac{91}{3}$ . Find the three terms.

**Solution** Since the product of 3 consecutive terms is given.

we can take them as  $\frac{a}{r}, a, ar$ .

Product of the terms = 343

$$\frac{a}{r} \times a \times ar = 343$$

$$a^3 = 7^3 \Rightarrow a = 7$$

Sum of the terms =  $\frac{91}{3}$

Hence  $a\left(\frac{1}{r} + 1 + r\right) = \frac{91}{3} \Rightarrow 7\left(\frac{1+r+r^2}{r}\right) = \frac{91}{3}$

$$3 + 3r + 3r^2 = 13r \Rightarrow 3r^2 - 10r + 3 = 0$$

$$(3r - 1)(r - 3) = 0 \Rightarrow r = 3 \text{ or } r = \frac{1}{3}$$

If  $a = 7, r = 3$  then the three terms are  $\frac{7}{3}, 7, 21$ .

If  $a = 7, r = \frac{1}{3}$  then the three terms are  $21, 7, \frac{7}{3}$ .

### Condition for three numbers to be in G.P.

If  $a, b, c$  are in G.P. then  $b = ar, c = ar^2$ . So  $ac = a \times ar^2 = (ar)^2 = b^2$ . Thus  $b^2 = ac$

Similarly, if  $b^2 = ac$ , then  $\frac{b}{a} = \frac{c}{b}$ . So  $a, b, c$  are in G.P.

Thus three non-zero numbers  $a, b, c$  are in G.P. if and only if  $b^2 = ac$ .

### Thinking Corner

1. Split 64 into three parts such that the numbers are in G.P.
2. If  $a, b, c, \dots$  are in G.P. then  $2a, 2b, 2c, \dots$  are in \_\_\_\_\_
3. If  $3, x, 6.75$  are in G.P. then  $x$  is \_\_\_\_\_



### Progress Check

Three non-zero numbers  $a, b, c$  are in G.P. if and only if \_\_\_\_\_.

**Example 2.45** The present value of a machine is ₹40,000 and its value depreciates each year by 10%. Find the estimated value of the machine in the 6<sup>th</sup> year.

**Solution** The value of the machine at present is ₹40,000. Since it is depreciated at the rate of 10% after one year the value of the machine is 90% of the initial value.

That is the value of the machine at the end of the first year is  $40,000 \times \frac{90}{100}$

After two years, the value of the machine is 90% of the value in the first year.

Value of the machine at the end of the 2<sup>nd</sup> year is  $40,000 \times \left(\frac{90}{100}\right)^2$

Continuing this way, the value of the machine depreciates in the following way as

$$40000, 40000 \times \frac{90}{100}, 40000 \times \left(\frac{90}{100}\right)^2 \dots$$

This sequence is in the form of G.P. with first term 40,000 and common ratio  $\frac{90}{100}$ . For finding the value of the machine at the end of 5<sup>th</sup> year (i.e. in 6<sup>th</sup> year), we need to find the sixth term of this G.P.

Thus,  $n = 6$ ,  $a = 40,000$ ,  $r = \frac{90}{100}$ .

Using  $t_n = ar^{n-1}$ , we have  $t_6 = 40,000 \times \left(\frac{90}{100}\right)^{6-1} = 40000 \times \left(\frac{90}{100}\right)^5$

$$t_6 = 40,000 \times \frac{9}{10} \times \frac{9}{10} \times \frac{9}{10} \times \frac{9}{10} \times \frac{9}{10} = 23619.6$$

Therefore the value of the machine in 6<sup>th</sup> year = ₹23619.60



### Exercise 2.7

- Which of the following sequences are in G.P.?
  - 3, 9, 27, 81, ...
  - 4, 44, 444, 4444, ...
  - 0.5, 0.05, 0.005, ...
  - $\frac{1}{3}, \frac{1}{6}, \frac{1}{12}, \dots$
  - 1, -5, 25, -125, ...
  - 120, 60, 30, 18, ...
  - 16, 4, 1,  $\frac{1}{4}, \dots$
- Write the first three terms of the G.P. whose first term and the common ratio are given below.
  - $a = 6, r = 3$
  - $a = \sqrt{2}, r = \sqrt{2}$
  - $a = 1000, r = \frac{2}{5}$
- In a G.P. 729, 243, 81, ... find  $t_7$ .
- Find  $x$  so that  $x + 6$ ,  $x + 12$  and  $x + 15$  are consecutive terms of a Geometric Progression.
- Find the number of terms in the following G.P.
  - 4, 8, 16, ..., 8192?
  - $\frac{1}{3}, \frac{1}{9}, \frac{1}{27}, \dots, \frac{1}{2187}$

6. In a G.P. the 9<sup>th</sup> term is 32805 and 6<sup>th</sup> term is 1215. Find the 12<sup>th</sup> term.
7. Find the 10<sup>th</sup> term of a G.P. whose 8<sup>th</sup> term is 768 and the common ratio is 2.
8. If  $a, b, c$  are in A.P. then show that  $3^a, 3^b, 3^c$  are in G.P.
9. In a G.P. the product of three consecutive terms is 27 and the sum of the product of two terms taken at a time is  $\frac{57}{2}$ . Find the three terms.
10. A man joined a company as Assistant Manager. The company gave him a starting salary of ₹60,000 and agreed to increase his salary 5% annually. What will be his salary after 5 years?
11. Sivamani is attending an interview for a job and the company gave two offers to him.  
Offer A: ₹20,000 to start with followed by a guaranteed annual increase of 6% for the first 5 years.  
Offer B: ₹22,000 to start with followed by a guaranteed annual increase of 3% for the first 5 years.  
What is his salary in the 4<sup>th</sup> year with respect to the offers A and B?
12. If  $a, b, c$  are three consecutive terms of an A.P. and  $x, y, z$  are three consecutive terms of a G.P. then prove that  $x^{b-c} \times y^{c-a} \times z^{a-b} = 1$ .

## 2.10 Sum to $n$ terms of a Geometric progression

A series whose terms are in Geometric progression is called **Geometric series**.

Let  $a, ar, ar^2, \dots, ar^{n-1}, \dots$  be the Geometric Progression.

The sum of first  $n$  terms of the Geometric progression is

$$S_n = a + ar + ar^2 + \dots + ar^{n-2} + ar^{n-1} \quad \dots (1)$$

Multiplying both sides by  $r$ , we get  $rS_n = ar + ar^2 + ar^3 + \dots + ar^{n-1} + ar^n \quad \dots (2)$

$$(2)-(1) \Rightarrow rS_n - S_n = ar^n - a$$

$$S_n(r-1) = a(r^n - 1)$$

Thus, the sum to  $n$  terms is  $S_n = \frac{a(r^n - 1)}{r - 1}, r \neq 1$ .

### Note

The above formula for sum of first  $n$  terms of a G.P. is not applicable when  $r = 1$ .

If  $r = 1$ , then

$$S_n = a + a + a + \dots + a = na$$



### Progress Check

1. A series whose terms are in Geometric progression is called \_\_\_\_\_.
2. When  $r = 1$ , the formula for finding sum to  $n$  terms of a G.P. is \_\_\_\_\_.
3. When  $r \neq 1$ , the formula for finding sum to  $n$  terms of a G.P. is \_\_\_\_\_.

### 2.10.1 Sum to infinite terms of a G.P.

The sum of infinite terms of a G.P. is given by  $S_{\infty} = a + ar + ar^2 + ar^3 + \dots = \frac{a}{1-r}$ ,  $-1 < r < 1$

**Example 2.46** Find the sum of 8 terms of the G.P.  $1, -3, 9, -27, \dots$

**Solutions** Here, the first term  $a = 1$ , common ratio  $r = \frac{-3}{1} = -3 < 1$ , Here,  $n = 8$ .

Sum to  $n$  terms of a G.P. is  $S_n = \frac{a(r^n - 1)}{r - 1}$  if  $r \neq 1$

$$\text{Hence, } S_8 = \frac{1((-3)^8 - 1)}{(-3) - 1} = \frac{6561 - 1}{-4} = -1640$$

**Example 2.47** Find the first term of a G.P. in which  $S_6 = 4095$  and  $r = 4$ .

**Solution** Common ratio  $= 4 > 1$ , Sum of first 6 terms  $S_6 = 4095$

$$\text{Hence, } S_6 = \frac{a(r^6 - 1)}{r - 1} = 4095$$

$$\therefore r = 4, \frac{a(4^6 - 1)}{4 - 1} = 4095 \Rightarrow a \times \frac{4095}{3} = 4095$$

$$\text{First term } a = 3.$$

**Example 2.48** How many terms of the series  $1 + 4 + 16 + \dots$  make the sum 1365?

**Solution** Let  $n$  be the number of terms to be added to get the sum 1365

$$a = 1, r = \frac{4}{1} = 4 > 1$$

$$S_n = 1365 \Rightarrow \frac{a(r^n - 1)}{r - 1} = 1365$$

$$\frac{1(4^n - 1)}{4 - 1} = 1365 \text{ so, } (4^n - 1) = 4095$$

$$4^n = 4096 \text{ then } 4^n = 4^6$$

$$n = 6$$

**Example 2.49** Find the sum  $3 + 1 + \frac{1}{3} + \dots \infty$

**Solution** Here  $a = 3$ ,  $r = \frac{t_2}{t_1} = \frac{1}{3}$

$$\text{Sum of infinite terms } S_{\infty} = \frac{a}{1-r} = \frac{3}{1-\frac{1}{3}} = \frac{9}{2}$$

**Example 2.50** Find the rational form of the number  $0.6666\dots$

**Solution** We can express the number  $0.6666\dots$  as follows

$$0.6666\dots = 0.6 + 0.06 + 0.006 + 0.0006 + \dots$$

We now see that numbers  $0.6, 0.06, 0.006, \dots$  form a G.P. whose first term  $a = 0.6$  and common ratio  $r = \frac{0.06}{0.6} = 0.1$ . Also  $-1 < r = 0.1 < 1$

Using the infinite G.P. formula, we have

$$0.6666\dots = 0.6 + 0.06 + 0.006 + 0.0006 + \dots = \frac{0.6}{1-0.1} = \frac{0.6}{0.9} = \frac{2}{3}$$

Thus the rational number equivalent of  $0.6666\dots$  is  $\frac{2}{3}$



#### Progress Check

1. Sum to infinite number of terms of a G.P. is \_\_\_\_.
2. For what values of  $r$ , does the formula for infinite G.P. valid?





### Activity 5

The sides of a given square is 10 cm. The mid points of its sides are joined to form a new square. Again, the mid points of the sides of this new square are joined to form another square. This process is continued indefinitely. Find the sum of the areas and the sum of the perimeters of the squares formed through this process.

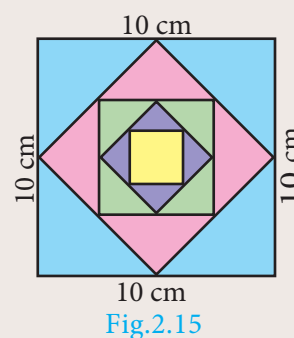

**Example 2.51** Find the sum to  $n$  terms of the series  $5 + 55 + 555 + \dots$

**Solution** The series is neither Arithmetic nor Geometric series. So it can be split into two series and then find the sum.

$$\begin{aligned} 5 + 55 + 555 + \dots + n \text{ terms} &= 5[1 + 11 + 111 + \dots + n \text{ terms}] \\ &= \frac{5}{9}[9 + 99 + 999 + \dots + n \text{ terms}] \\ &= \frac{5}{9}[(10 - 1) + (100 - 1) + (1000 - 1) + \dots + n \text{ terms}] \\ &= \frac{5}{9}[(10 + 100 + 1000 + \dots + n \text{ terms}) - n] \\ &= \frac{5}{9}\left[\frac{10(10^n - 1)}{(10 - 1)} - n\right] = \frac{50(10^n - 1)}{81} - \frac{5n}{9} \end{aligned}$$



### Progress Check

1. Is the series  $3 + 33 + 333 + \dots$  a Geometric series?
2. The value of  $r$ , such that  $1 + r + r^2 + r^3 \dots = \frac{3}{4}$  is \_\_\_\_.

**Example 2.52** Find the least positive integer  $n$  such that  $1 + 6 + 6^2 + \dots + 6^n > 5000$

**Solution** We have to find the least number of terms for which the sum must be greater than 5000.

That is, to find the least value of  $n$ , such that  $S_n > 5000$

$$\text{We have, } S_n = \frac{a(r^n - 1)}{r - 1} = \frac{1(6^n - 1)}{6 - 1} = \frac{6^n - 1}{5}$$

$$S_n > 5000 \Rightarrow \frac{6^n - 1}{5} > 5000$$

$$6^n - 1 > 25000 \Rightarrow 6^n > 25001$$

$$\therefore 6^5 = 7776 \text{ and } 6^6 = 46656$$

The least positive value of  $n$  is 6 such that  $1 + 6 + 6^2 + \dots + 6^n > 5000$ .

**Example 2.53** A person saved money every year, half as much as he could in the previous year. If he had totally saved ₹ 7875 in 6 years then how much did he save in the first year?

**Solution** Total amount saved in 6 years is  $S_6 = 7875$

Since he saved half as much money as every year he saved in the previous year,

We have  $r = \frac{1}{2} < 1$

$$\frac{a(1-r^n)}{1-r} = \frac{a\left(1-\left(\frac{1}{2}\right)^6\right)}{1-\frac{1}{2}} = 7875$$

$$\frac{a\left(1-\frac{1}{64}\right)}{\frac{1}{2}} = 7875 \Rightarrow a \times \frac{63}{32} = 7875$$

$$a = \frac{7875 \times 32}{63}$$

$$a = 4000$$

The amount saved in the first year is ₹ 4000.



### Exercise 2.8

- Find the sum of first  $n$  terms of the G.P. (i)  $5, -3, \frac{9}{5}, -\frac{27}{25}, \dots$  (ii)  $256, 64, 16, \dots$
- Find the sum of first six terms of the G.P.  $5, 15, 45, \dots$
- Find the first term of the G.P. whose common ratio 5 and whose sum to first 6 terms is 46872.
- Find the sum to infinity of (i)  $9 + 3 + 1 + \dots$  (ii)  $21 + 14 + \frac{28}{3} + \dots$
- If the first term of an infinite G.P. is 8 and its sum to infinity is  $\frac{32}{3}$  then find the common ratio.
- Find the sum to  $n$  terms of the series  
(i)  $0.4 + 0.44 + 0.444 + \dots$  to  $n$  terms (ii)  $3 + 33 + 333 + \dots$  to  $n$  terms
- Find the sum of the Geometric series  $3 + 6 + 12 + \dots + 1536$ .
- Kumar writes a letter to four of his friends. He asks each one of them to copy the letter and mail to four different persons with the instruction that they continue the process similarly. Assuming that the process is unaltered and it costs ₹2 to mail one letter, find the amount spent on postage when  $8^{\text{th}}$  set of letters is mailed.
- Find the rational form of the number  $0.\overline{123}$ .
- If  $S_n = (x + y) + (x^2 + xy + y^2) + (x^3 + x^2y + xy^2 + y^3) + \dots + n$  terms then prove that  

$$(x - y)S_n = \left[ \frac{x^2(x^n - 1)}{x - 1} - \frac{y^2(y^n - 1)}{y - 1} \right]$$

## 2.11 Special Series

There are some series whose sum can be expressed by explicit formulae. Such series are called **special series**.

Here we study some common special series like

- (i) Sum of first ‘ $n$ ’ natural numbers
- (ii) Sum of first ‘ $n$ ’ odd natural numbers.
- (iii) Sum of squares of first ‘ $n$ ’ natural numbers.
- (iv) Sum of cubes of first ‘ $n$ ’ natural numbers.

We can derive the formula for sum of any powers of first  $n$  natural numbers using the expression  $(x + 1)^{k+1} - x^{k+1}$ . That is to find  $1^k + 2^k + 3^k + \dots + n^k$  we can use the expression  $(x + 1)^{k+1} - x^{k+1}$ .

### 2.11.1 Sum of first $n$ natural numbers

To find  $1 + 2 + 3 + \dots + n$ , let us consider the identity  $(x + 1)^2 - x^2 = 2x + 1$

Where  $x = 1, 2, 3, \dots, n - 1, n$

$$\begin{aligned} x = 1, & \quad 2^2 - 1^2 = 2(1) + 1 \\ x = 2, & \quad 3^2 - 2^2 = 2(2) + 1 \\ x = 3, & \quad 4^2 - 3^2 = 2(3) + 1 \\ & \quad \vdots \quad \quad \quad \vdots \\ x = n - 1, & \quad n^2 - (n - 1)^2 = 2(n - 1) + 1 \\ x = n, & \quad (n + 1)^2 - n^2 = 2(n) + 1 \end{aligned}$$

Adding all these equations and cancelling the terms on the Left Hand side, we get,

$$\begin{aligned} (n + 1)^2 - 1^2 &= 2(1 + 2 + 3 + \dots + n) + n \\ n^2 + 2n &= 2(1 + 2 + 3 + \dots + n) + n \\ 2(1 + 2 + 3 + \dots + n) &= n^2 + n = n(n + 1) \\ 1 + 2 + 3 + \dots + n &= \frac{n(n + 1)}{2} \end{aligned}$$

### 2.11.2 Sum of first $n$ odd natural numbers

$$1 + 3 + 5 + \dots + (2n - 1)$$

It is an A.P. with  $a = 1$ ,  $d = 2$  and  $l = 2n - 1$

$$\begin{aligned} S_n &= \frac{n}{2} [a + l] \\ &= \frac{n}{2} [1 + 2n - 1] \\ S_n &= \frac{n}{2} \times 2n = n^2 \end{aligned}$$

### 2.11.3 Sum of squares of first $n$ natural numbers

To find  $1^2 + 2^2 + 3^2 + \dots + n^2$ , let us consider the identity  $(x + 1)^3 - x^3 = 3x^2 + 3x + 1$

Where  $x = 1, 2, 3, \dots, n - 1, n$

$$\begin{aligned} x = 1, & \quad 2^3 - 1^3 = 3(1)^2 + 3(1) + 1 \\ x = 2, & \quad 3^3 - 2^3 = 3(2)^2 + 3(2) + 1 \\ x = 3, & \quad 4^3 - 3^3 = 3(3)^2 + 3(3) + 1 \\ & \quad \vdots \quad \quad \quad \vdots \\ x = n - 1, & \quad n^3 - (n - 1)^3 = 3(n - 1)^2 + 3(n - 1) + 1 \\ x = n, & \quad (n + 1)^3 - n^3 = 3n^2 + 3n + 1 \end{aligned}$$

Adding all these equations and cancelling the terms on the Left Hand side, we get,

$$\begin{aligned} (n+1)^3 - 1^3 &= 3(1^2 + 2^2 + 3^2 + \dots + n^2) + 3(1 + 2 + 3 + \dots + n) + n \\ n^3 + 3n^2 + 3n &= 3(1^2 + 2^2 + 3^2 + \dots + n^2) + \frac{3n(n+1)}{2} + n \\ 3(1^2 + 2^2 + 3^2 + \dots + n^2) &= n^3 + 3n^2 + 2n - \frac{3n(n+1)}{2} = \frac{2n^3 + 6n^2 + 4n - 3n^2 - 3n}{2} \\ 3(1^2 + 2^2 + 3^2 + \dots + n^2) &= \frac{2n^3 + 3n^2 + n}{2} = \frac{n(2n^2 + 3n + 1)}{2} = \frac{n(n+1)(2n+1)}{2} \\ 1^2 + 2^2 + 3^2 + \dots + n^2 &= \frac{n(n+1)(2n+1)}{6} \end{aligned}$$

### 2.11.4 Sum of cubes of first $n$ natural numbers

To find  $1^3 + 2^3 + 3^3 + \dots + n^3$ , let us consider the identity  
 $(x+1)^4 - x^4 = 4x^3 + 6x^2 + 4x + 1$

Where  $x = 1, 2, 3, \dots, n - 1, n$

$$\begin{aligned} x = 1, \quad 2^4 - 1^4 &= 4(1)^3 + 6(1)^2 + 4(1) + 1 \\ x = 2, \quad 3^4 - 2^4 &= 4(2)^3 + 6(2)^2 + 4(2) + 1 \\ x = 3, \quad 4^4 - 3^4 &= 4(3)^3 + 6(3)^2 + 4(3) + 1 \\ &\vdots \\ x = n - 1, \quad n^4 - (n - 1)^4 &= 4(n - 1)^3 + 6(n - 1)^2 + 4(n - 1) + 1 \\ x = n, \quad (n + 1)^4 - n^4 &= 4n^3 + 6n^2 + 4n + 1 \end{aligned}$$

Adding all these equations and cancelling the terms on the Left Hand side, we get,

$$\begin{aligned} (n+1)^4 - 1^4 &= 4(1^3 + 2^3 + 3^3 + \dots + n^3) + 6(1^2 + 2^2 + 3^2 + \dots + n^2) + 4(1 + 2 + 3 + \dots + n) + n \\ n^4 + 4n^3 + 6n^2 + 4n &= 4(1^3 + 2^3 + 3^3 + \dots + n^3) + 6 \times \frac{n(n+1)(2n+1)}{6} + 4 \times \frac{n(n+1)}{2} + n \\ 4(1^3 + 2^3 + 3^3 + \dots + n^3) &= n^4 + 4n^3 + 6n^2 + 4n - 2n^3 - n^2 - 2n^2 - n - 2n^2 - 2n - n \\ 4(1^3 + 2^3 + 3^3 + \dots + n^3) &= n^4 + 2n^3 + n^2 = n^2(n^2 + 2n + 1) = n^2(n+1)^2 \\ 1^3 + 2^3 + 3^3 + \dots + n^3 &= \left( \frac{n(n+1)}{2} \right)^2 \end{aligned}$$

### Ideal Friendship



Consider the numbers 220 and 284.

Sum of the divisors of 220 (excluding 220) =  $1+2+4+5+10+11+20+22+44+55+110=284$

Sum of the divisors of 284 (excluding 284) =  $1+2+4+71+142=220$ .

Thus, sum of divisors of one number excluding itself is the other. Such pair of numbers is called **Amicable Numbers** or **Friendly Numbers**.

220 and 284 are least pair of Amicable Numbers. They were discovered by Pythagoras. We now know more than 12 million amicable pair of Numbers.





### Activity 6

Take a triangle like this

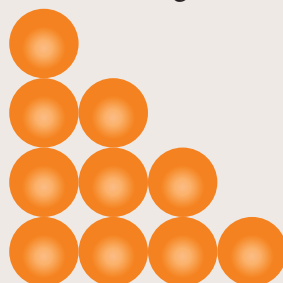

Fig.2.16  $(1 + 2 + 3 + 4)$

Make another triangle like this.

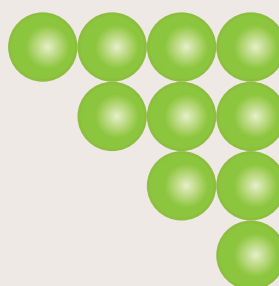

Fig.2.17  $(4 + 3 + 2 + 1)$

Join the second triangle with the first to get

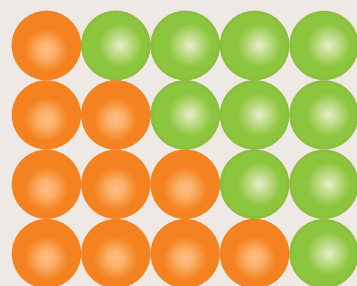

Fig.2.18

Thus, two copies of  $1 + 2 + 3 + 4$  provide a rectangle of size  $4 \times 5$ .

We can write in numbers, what we did with pictures.

Let us write,  $(4 + 3 + 2 + 1) + (1 + 2 + 3 + 4) = 4 \times 5$

$$2(1 + 2 + 3 + 4) = 4 \times 5$$

Therefore,  $1 + 2 + 3 + 4 = \frac{4 \times 5}{2} = 10$

In a similar, fashion, try to find the sum of first 5 natural numbers. Can you relate these answers to any of the known formula?

1. The sum of first  $n$  natural numbers are also called **Triangular Numbers** because they form triangle shapes.
2. The sum of squares of first  $n$  natural numbers are also called **Square Pyramidal Numbers** because they form pyramid shapes with square base.



### Thinking Corner



1. How many squares are there in a standard chess board?
2. How many rectangles are there in a standard chess board?

Here is a summary of list of some useful summation formulae which we discussed. These formulae are used in solving summation problems with finite terms.

$$\sum_{k=1}^n k = 1 + 2 + 3 + \dots + n = \frac{n(n+1)}{2}$$

$$\sum_{k=1}^n (2k-1) = 1 + 2 + 3 + \dots + (2n-1) = n^2$$

$$\sum_{k=1}^n k^2 = 1^2 + 2^2 + 3^2 + \dots + n^2 = \frac{n(n+1)(2n+1)}{6}$$

$$\sum_{k=1}^n k^3 = 1^3 + 2^3 + 3^3 + \dots + n^3 = \left[ \frac{n(n+1)}{2} \right]^2$$

**Example 2.54** Find the value of (i)  $1 + 2 + 3 + \dots + 50$  (ii)  $16 + 17 + 18 + \dots + 75$

**Solution** (i)  $1 + 2 + 3 + \dots + 50$

$$\text{Using, } 1 + 2 + 3 + \dots + n = \frac{n(n+1)}{2}$$

$$1 + 2 + 3 + \dots + 50 = \frac{50 \times (50 + 1)}{2} = 1275$$

$$\begin{aligned} \text{(ii) } 16 + 17 + 18 + \dots + 75 &= (1 + 2 + 3 + \dots + 75) - (1 + 2 + 3 + \dots + 15) \\ &= \frac{75(75 + 1)}{2} - \frac{15(15 + 1)}{2} \\ &= 2850 - 120 = 2730 \end{aligned}$$



### Progress Check

- The sum of cubes of first  $n$  natural numbers is \_\_\_\_\_ of the first  $n$  natural numbers.
- The average of first 100 natural numbers is \_\_\_\_\_.

**Example 2.55** Find the sum of (i)  $1 + 3 + 5 + \dots$  to 40 terms

(ii)  $2 + 4 + 6 + \dots + 80$  (iii)  $1 + 3 + 5 + \dots + 55$

**Solution** (i)  $1 + 3 + 5 + \dots$  40 terms  $= 40^2 = 1600$

$$\text{(ii) } 2 + 4 + 6 + \dots + 80 = 2(1 + 2 + 3 + \dots + 40) = 2 \times \frac{40 \times (40 + 1)}{2} = 1640$$

$$\text{(iii) } 1 + 3 + 5 + \dots + 55$$

Here the number of terms is not given. Now we have to find the number of terms using the formula,  $n = \frac{(l - a)}{d} + 1 \Rightarrow n = \frac{(55 - 1)}{2} + 1 = 28$

$$\text{Therefore, } 1 + 3 + 5 + \dots + 55 = (28)^2 = 784$$

**Example 2.56** Find the sum of (i)  $1^2 + 2^2 + \dots + 19^2$

(ii)  $5^2 + 10^2 + 15^2 + \dots + 105^2$  (iii)  $15^2 + 16^2 + 17^2 + \dots + 28^2$

$$\text{Solution (i) } 1^2 + 2^2 + \dots + 19^2 = \frac{19 \times (19 + 1)(2 \times 19 + 1)}{6} = \frac{19 \times 20 \times 39}{6} = 2470$$

$$\begin{aligned} \text{(ii) } 5^2 + 10^2 + 15^2 + \dots + 105^2 &= 5^2(1^2 + 2^2 + 3^2 + \dots + 21^2) \\ &= 25 \times \frac{21 \times (21 + 1)(2 \times 21 + 1)}{6} \\ &= \frac{25 \times 21 \times 22 \times 43}{6} = 82775 \end{aligned}$$

$$\begin{aligned} \text{(iii) } 15^2 + 16^2 + 17^2 + \dots + 28^2 &= (1^2 + 2^2 + 3^2 + \dots + 28^2) - (1^2 + 2^2 + 3^2 + \dots + 14^2) \\ &= \frac{28 \times 29 \times 57}{6} - \frac{14 \times 15 \times 29}{6} = 7714 - 1015 = 6699 \end{aligned}$$



**Example 2.57** Find the sum of (i)  $1^3 + 2^3 + 3^3 + \dots + 16^3$  (ii)  $9^3 + 10^3 + \dots + 21^3$

**Solution** (i)  $1^3 + 2^3 + 3^3 + \dots + 16^3 = \left[ \frac{16 \times (16 + 1)}{2} \right]^2 = (136)^2 = 18496$

(ii)  $9^3 + 10^3 + \dots + 21^3 = (1^3 + 2^3 + 3^3 + \dots + 21^3) - (1^3 + 2^3 + 3^3 + \dots + 8^3)$   
 $= \left[ \frac{21 \times (21 + 1)}{2} \right]^2 - \left[ \frac{8 \times (8 + 1)}{2} \right]^2 = (231)^2 - (36)^2 = 52065$

**Example 2.58** If  $1 + 2 + 3 + \dots + n = 666$  then find  $n$ .

**Solution** Since,  $1 + 2 + 3 + \dots + n = \frac{n(n+1)}{2}$ , we have  $\frac{n(n+1)}{2} = 666$

$$n^2 + n - 1332 = 0 \Rightarrow (n + 37)(n - 36) = 0$$

So,  $n = -37$  or  $n = 36$

But  $n \neq -37$  ( $\because n$  is a natural number); Hence  $n = 36$ .



### Progress Check

Say True or False. Justify them.

- The sum of first  $n$  odd natural numbers is always an odd number.
- The sum of consecutive even numbers is always an even number.
- The difference between the sum of squares of first  $n$  natural numbers and the sum of first  $n$  natural numbers is always divisible by 2.
- The sum of cubes of the first  $n$  natural numbers is always a square number.



### Exercise 2.9

- Find the sum of the following series
  - $1 + 2 + 3 + \dots + 60$
  - $3 + 6 + 9 + \dots + 96$
  - $51 + 52 + 53 + \dots + 92$
  - $1 + 4 + 9 + 16 + \dots + 225$
  - $6^2 + 7^2 + 8^2 + \dots + 21^2$
  - $10^3 + 11^3 + 12^3 + \dots + 20^3$
  - $1 + 3 + 5 + \dots + 71$
- If  $1 + 2 + 3 + \dots + k = 325$ , then find  $1^3 + 2^3 + 3^3 + \dots + k^3$ .
- If  $1^3 + 2^3 + 3^3 + \dots + k^3 = 44100$  then find  $1 + 2 + 3 + \dots + k$ .
- How many terms of the series  $1^3 + 2^3 + 3^3 + \dots$  should be taken to get the sum 14400?
- The sum of the cubes of the first  $n$  natural numbers is 2025, then find the value of  $n$ .
- Rekha has 15 square colour papers of sizes 10 cm, 11 cm, 12 cm, ..., 24 cm. How much area can be decorated with these colour papers?
- Find the sum of the series  $(2^3 - 1^3) + (4^3 - 3^3) + (6^3 - 5^3) + \dots$  to
  - $n$  terms
  - 8 terms



### Exercise 2.10



### Multiple choice questions

- Euclid's division lemma states that for positive integers  $a$  and  $b$ , there exist unique integers  $q$  and  $r$  such that  $a = bq + r$ , where  $r$  must satisfy.  
 (A)  $1 < r < b$       (B)  $0 < r < b$       (C)  $0 \leq r < b$       (D)  $0 < r \leq b$
- Using Euclid's division lemma, if the cube of any positive integer is divided by 9 then the possible remainders are  
 (A) 0, 1, 8      (B) 1, 4, 8      (C) 0, 1, 3      (D) 1, 3, 5
- If the HCF of 65 and 117 is expressible in the form of  $65m - 117$ , then the value of  $m$  is  
 (A) 4      (B) 2      (C) 1      (D) 3
- The sum of the exponents of the prime factors in the prime factorization of 1729 is  
 (A) 1      (B) 2      (C) 3      (D) 4
- The least number that is divisible by all the numbers from 1 to 10 (both inclusive) is  
 (A) 2025      (B) 5220      (C) 5025      (D) 2520
- $7^{4k} \equiv \underline{\hspace{2cm}} \pmod{100}$   
 (A) 1      (B) 2      (C) 3      (D) 4
- Given  $F_1 = 1$ ,  $F_2 = 3$  and  $F_n = F_{n-1} + F_{n-2}$  then  $F_5$  is  
 (A) 3      (B) 5      (C) 8      (D) 11
- The first term of an arithmetic progression is unity and the common difference is 4. Which of the following will be a term of this A.P.  
 (A) 4551      (B) 10091      (C) 7881      (D) 13531
- If 6 times of 6<sup>th</sup> term of an A.P. is equal to 7 times the 7<sup>th</sup> term, then the 13<sup>th</sup> term of the A.P. is  
 (A) 0      (B) 6      (C) 7      (D) 13
- An A.P. consists of 31 terms. If its 16<sup>th</sup> term is  $m$ , then the sum of all the terms of this A.P. is  
 (A) 16  $m$       (B) 62  $m$       (C) 31  $m$       (D)  $\frac{31}{2} m$
- In an A.P., the first term is 1 and the common difference is 4. How many terms of the A.P. must be taken for their sum to be equal to 120?  
 (A) 6      (B) 7      (C) 8      (D) 9
- If  $A = 2^{65}$  and  $B = 2^{64} + 2^{63} + 2^{62} + \dots + 2^0$  which of the following is true?  
 (A)  $B$  is  $2^{64}$  more than  $A$       (B)  $A$  and  $B$  are equal  
 (C)  $B$  is larger than  $A$  by 1      (D)  $A$  is larger than  $B$  by 1



13. The next term of the sequence  $\frac{3}{16}, \frac{1}{8}, \frac{1}{12}, \frac{1}{18}, \dots$  is  
 (A)  $\frac{1}{24}$  (B)  $\frac{1}{27}$  (C)  $\frac{2}{3}$  (D)  $\frac{1}{81}$
14. If the sequence  $t_1, t_2, t_3, \dots$  are in A.P. then the sequence  $t_6, t_{12}, t_{18}, \dots$  is  
 (A) a Geometric Progression (B) an Arithmetic Progression  
 (C) neither an Arithmetic Progression nor a Geometric Progression  
 (D) a constant sequence
15. The value of  $(1^3 + 2^3 + 3^3 + \dots + 15^3) - (1 + 2 + 3 + \dots + 15)$  is  
 (A) 14400 (B) 14200 (C) 14280 (D) 14520

### Unit Exercise - 2



- Prove that  $n^2 - n$  divisible by 2 for every positive integer  $n$ .
- A milk man has 175 litres of cow's milk and 105 litres of buffalow's milk. He wishes to sell the milk by filling the two types of milk in cans of equal capacity. Calculate the following (i) Capacity of a can (ii) Number of cans of cow's milk (iii) Number of cans of buffalow's milk.
- When the positive integers  $a, b$  and  $c$  are divided by 13 the respective remainders are 9, 7 and 10. Find the remainder when  $a + 2b + 3c$  is divided by 13.
- Show that 107 is of the form  $4q + 3$  for any integer  $q$ .
- If  $(m + 1)^{\text{th}}$  term of an A.P. is twice the  $(n + 1)^{\text{th}}$  term, then prove that  $(3m + 1)^{\text{th}}$  term is twice the  $(m + n + 1)^{\text{th}}$  term.
- Find the 12<sup>th</sup> term from the last term of the A. P  $-2, -4, -6, \dots - 100$ .
- Two A.P.'s have the same common difference. The first term of one A.P. is 2 and that of the other is 7. Show that the difference between their 10<sup>th</sup> terms is the same as the difference between their 21<sup>st</sup> terms, which is the same as the difference between any two corresponding terms.
- A man saved ₹16500 in ten years. In each year after the first he saved ₹100 more than he did in the preceding year. How much did he save in the first year?
- Find the G.P. in which the 2<sup>nd</sup> term is  $\sqrt{6}$  and the 6<sup>th</sup> term is  $9\sqrt{6}$ .
- The value of a motor cycle depreciates at the rate of 15% per year. What will be the value of the motor cycle 3 year hence, which is now purchased for ₹ 45,000?

### Points to Remember



- Euclid's division lemma**

If  $a$  and  $b$  are two positive integers then there exist unique integers  $q$  and  $r$  such that  $a = bq + r$ ,  $0 \leq r < |b|$

- Fundamental theorem of arithmetic**

Every composite number can be expressed as a product of primes and this factorization is unique except for the order in which the prime factors occur.

● **Arithmetic Progression**

(i) Arithmetic Progression is  $a, a + d, a + 2d, a + 3d, \dots$ .  $n^{\text{th}}$  term is given by  $t_n = a + (n - 1)d$

(ii) Sum to first  $n$  terms of an A.P. is  $S_n = \frac{n}{2}[2a + (n - 1)d]$

(iii) If the last term  $l$  ( $n^{\text{th}}$  term) is given, then  $S_n = \frac{n}{2}[a + l]$

● **Geometric Progression**

(i) Geometric Progression is  $a, ar, ar^2, \dots, ar^{n-1}$ .  $n^{\text{th}}$  term is given by  $t_n = ar^{n-1}$

(ii) Sum to first  $n$  terms of an G.P. is  $S_n = \frac{a(r^n - 1)}{r - 1}$  if  $r \neq 1$

(iii) Suppose  $r = 1$  then  $S_n = na$

(iv) Sum to infinite terms of a G.P.  $a + ar + ar^2 + \dots$  is  $S_\infty = \frac{a}{1 - r}$ , where  $-1 < r < 1$

● **Special Series**

(i) The sum of first  $n$  natural numbers  $1 + 2 + 3 + \dots + n = \frac{n(n + 1)}{2}$

(ii) The sum of squares of first  $n$  natural numbers

$$1^2 + 2^2 + 3^2 + \dots + n^2 = \frac{n(n + 1)(2n + 1)}{6}$$

(iii) The sum of cubes of first  $n$  natural numbers  $1^3 + 2^3 + 3^3 + \dots + n^3 = \left[ \frac{n(n + 1)}{2} \right]^2$

(iv) The sum of first  $n$  odd natural numbers  $1 + 3 + 5 + \dots + (2n - 1) = n^2$

**ICT CORNER**



**ICT 2.1**

**Step 1:** Open the Browser type the URL Link given below (or) Scan the QR Code. GeoGebra work book named “Numbers and Sequences” will open. In the left side of the work book there are many activity related to mensuration chapter. Select the work sheet “Euclid’s Lemma division”

**Step 2:** In the given worksheet Drag the point mentioned as “Drag Me” to get new set of points. Now compare the Division algorithm you learned from textbook.

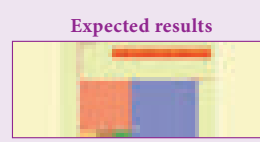
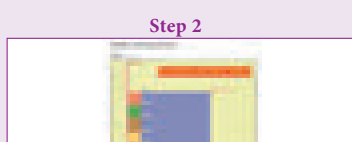

**ICT 2.2**

**Step 1:** Open the Browser type the URL Link given below (or) Scan the QR Code. GeoGebra work book named “Numbers and Sequences” will open. In the left side of the work book there are many activity related to mensuration chapter. Select the work sheet “Bouncing Ball Problem”.

**Step 2:** In the given worksheet you can change the height, Number of bounces and debounce ratio by typing new value. Then click “Get Ball”, and then click “Drop”. The ball bounces as per your value entered. Observe the working given on right hand side to learn the sum of sequence.

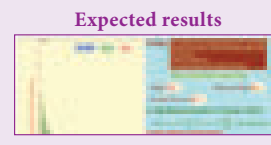
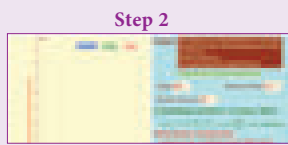

You can repeat the same steps for other activities

<https://www.geogebra.org/m/jfr2zzgy#chapter/356192>  
or Scan the QR Code.



# 3

# ALGEBRA

“A person who can, within a year, solve  $x^2 - 92y^2 = 1$  is  
amathematician”

- Brahmagupta

Niccolo Fontana Tartaglia was an Italian mathematician, engineer, surveyor and bookkeeper from then Republic of Venice (now Italy). He published many books, including the first Italian translations of Archimedes and Euclid, and an acclaimed compilation of mathematics. Tartaglia was the first to apply mathematics to the investigation of the paths of cannonballs; his work was later validated by Galileo’s studies on falling bodies.



Niccolo Fontana Tartaglia  
1499/1500 – 1557 AD(CE)

Tartaglia along with Cardano were credited for finding methods to solve any third degree polynomials called cubic equations. He also provided a nice formula for calculating volume of any tetrahedron using distance between pairs of its four vertices.



## Learning Outcomes

- To solve system of linear equations in three variables by the method of elimination
- To find GCD and LCM of polynomials
- To simplify algebraic rational expressions
- To understand and compute the square root of polynomials
- To learn about quadratic equations
- To draw quadratic graphs
- To learn about matrix, its types and operations on matrices



## 3.1 Introduction

Algebra can be thought of as the next level of study of numbers. If we need to determine anything subject to certain specific conditions, then we need Algebra. In that sense, the study of Algebra is considered as “Science of determining unknowns”. During third century AD(CE) Diophantus of Alexandria wrote a monumental book titled “Arithmetica” in thirteen volumes of which only six has survived. This book is the first source where the conditions of the problems are stated as equations and they are eventually solved. Diophantus realized that for many real life situation problems, the variables considered are usually positive integers.

The term “Algebra” has evolved as a misspelling of the word ‘al-jabr’ from one of the important work titled Al-Kitāb al-mukhtaṣar fī hisāb al-jabr wa’l-muqābala (“The Compendious Book on Calculation by Completion and Balancing”) written by Persian Mathematician **Al-Khwarizmi** of 9<sup>th</sup> Century AD(CE) Since Al-Khwarizmi’s Al-Jabr book provided the most appropriate methods of solving equations, he is hailed as “**Father of Algebra**”.

In the earlier classes, we had studied several important concepts in Algebra. In this class, we will continue our journey to understand other important concepts which will be of much help in solving problems of greater scope. Real understanding of these ideas will benefit much in learning higher mathematics in future classes.

### Simultaneous Linear Equations in Two Variables

Let us recall solving a pair of linear equations in two variables.

#### Definition

##### Linear Equation in two variables

Any first degree equation containing two variables  $x$  and  $y$  is called a linear equation in two variables. The general form of linear equation in two variables  $x$  and  $y$  is  $ax+by+c=0$ , where atleast one of  $a, b$  is non-zero and  $a, b, c$  are real numbers.

Note that linear equations are first degree equations in the given variables.

#### Note

- $xy - 7 = 3$  is not a linear equation in two variables since the term  $xy$  is of degree 2.
- A linear equation in two variables represent a straight line in  $xy$  plane.

**Example 3.1** The father’s age is six times his son’s age. Six years hence the age of father will be four times his son’s age. Find the present ages (in years) of the son and father.

**Solution** Let the present age of father be  $x$  years and  
the present age of son be  $y$  years

$$\text{Given, } x = 6y \quad \dots (1)$$

$$x + 6 = 4(y + 6) \quad \dots (2)$$

Substituting (1) in (2),  $6y + 6 = 4(y + 6)$

$$6y + 6 = 4y + 24 \Rightarrow y = 9$$

Therefore, son’s age = 9 years and father’s age = 54 years.

**Example 3.2** Solve  $2x - 3y = 6$ ,  $x + y = 1$

$$\text{Solution } 2x - 3y = 6 \quad \dots (1)$$

$$x + y = 1 \quad \dots (2)$$

$$(1) \times 1 \Rightarrow 2x - 3y = 6$$

$$(2) \times 2 \Rightarrow 2x + 2y = 2$$

$$-5y = 4 \Rightarrow y = \frac{-4}{5}$$

Substituting  $y = \frac{-4}{5}$  in (2),  $x - \frac{4}{5} = 1$  we get,  $x = \frac{9}{5}$

Therefore,  $x = \frac{9}{5}$ ,  $y = \frac{-4}{5}$ .

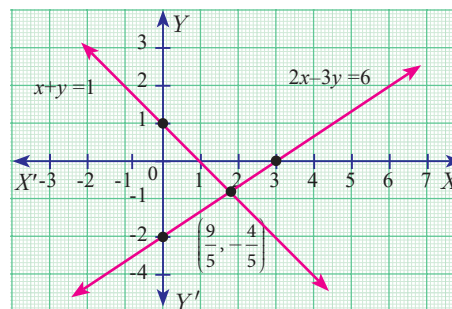

Fig. 3.1

### 3.2 Simultaneous Linear Equations in Three Variables

Right from the primitive needs of calculating amount spent for various items in a super market, finding ages of people under specific conditions, finding path of an object when it is thrown upwards at an angle, Algebra plays a vital role in our daily life.

Any point in the space can be determined uniquely by knowing its latitude, longitude and altitude. Hence to locate the position of an object at a particular place situated on the Earth, three satellites are positioned to arrive three equations. Among these three equations, we get two linear equations and one quadratic (second degree) equation. Hence we can solve for the variables latitude, longitude and altitude to uniquely fix the position of any object at a given point of time. This is the basis of

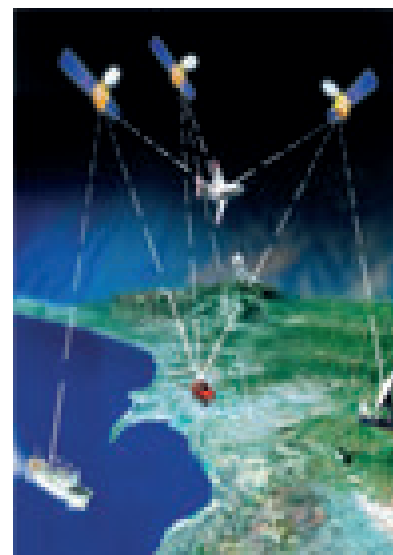

Fig. 3.2

**Geo-Positioning System** (GPS). Hence the concept of linear equations in three variables is used in **GPS systems**.

#### 3.2.1 System of Linear Equations in Three Variables

In earlier classes, we have learnt different methods of solving **Simultaneous Linear Equations** in two variables. Here we shall learn to solve the system of linear equations in three variables namely,  $x$ ,  $y$  and  $z$ . The general form of a linear equation in three variables  $x$ ,  $y$  and  $z$  is  $ax + by + cz + d = 0$  where  $a$ ,  $b$ ,  $c$ ,  $d$  are real numbers, and atleast one of  $a$ ,  $b$ ,  $c$  is non-zero.

**Note**

➤ A linear equation in two variables of the form  $ax + by + c = 0$ , represents a straight line.

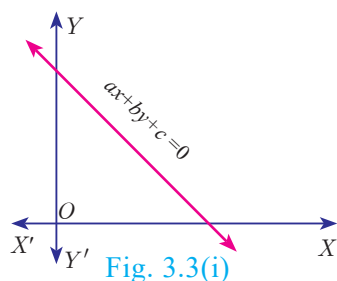

Fig. 3.3(i)

➤ A linear equation in three variables of the form  $ax + by + cz + d = 0$ , represents a plane.

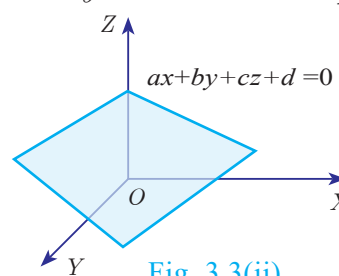

Fig. 3.3(ii)

**General Form:** A system of linear equations in three variables  $x, y, z$  has the general form

$$\begin{aligned} a_1x + b_1y + c_1z + d_1 &= 0 \\ a_2x + b_2y + c_2z + d_2 &= 0 \\ a_3x + b_3y + c_3z + d_3 &= 0 \end{aligned}$$

Each equation in the system represents a plane in three dimensional space and solution of the system of equations is precisely the point of intersection of the three planes defined by the three linear equations of the system. The system may have only one solution, infinitely many solutions or no solution depending on how the planes intersect one another.

The figures presented below illustrate each of these possibilities

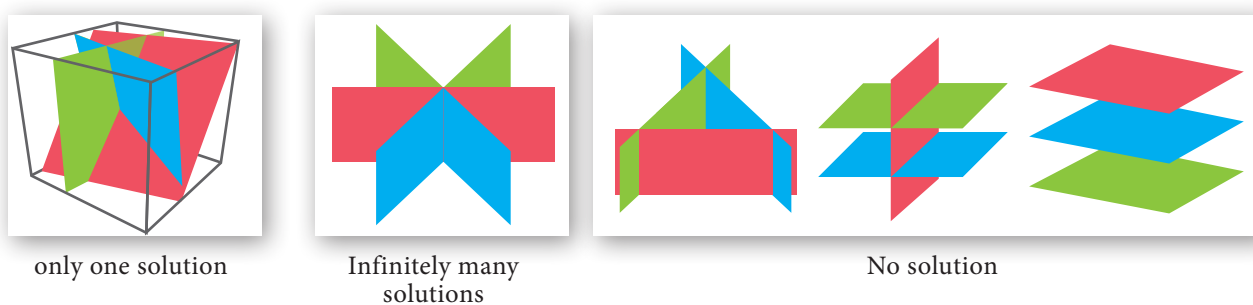

Fig. 3.4

### Procedure for solving system of linear equations in three variables

- Step 1:** By taking any two equations from the given three, first multiply by some suitable non-zero constant to make the co-efficient of one variable (either  $x$  or  $y$  or  $z$ ) numerically equal.
- Step 2:** Eliminate one of the variables whose co-efficients are numerically equal from the equations.
- Step 3:** Eliminate the same variable from another pair.
- Step 4:** Now we have two equations in two variables.
- Step 5:** Solve them using any method studied in earlier classes.
- Step 6:** The remaining variable is then found by substituting in any one of the given equations.

**Note**

- If you obtain a false equation such as  $0=1$ , in any of the steps then the system has no solution.
- If you do not obtain a false solution, but obtain an identity, such as  $0=0$  then the system has infinitely many solutions.

**Example 3.3** Solve the following system of linear equations in three variables  $3x - 2y + z = 2, 2x + 3y - z = 5, x + y + z = 6$ .

**Solution**  $3x - 2y + z = 2 \dots(1)$      $2x + 3y - z = 5 \dots(2)$      $x + y + z = 6 \dots(3)$

$$\begin{array}{r} \text{Adding (1) and (2),} \\ 3x - 2y + z = 2 \\ 2x + 3y - z = 5 \\ \hline 5x + y = 7 \end{array} \quad \begin{array}{l} (+) \\ \\ \dots(4) \end{array}$$

$$\begin{array}{r} \text{Adding (2) and (3),} \\ 2x + 3y - z = 5 \\ x + y + z = 6 \\ \hline 3x + 4y = 11 \end{array} \quad \begin{array}{l} (+) \\ \\ \dots(5) \end{array}$$

$$\begin{array}{r} 4 \times (4) - (5) \\ 20x + 4y = 28 \\ 3x + 4y = 11 \\ \hline 17x = 17 \Rightarrow x = 1 \end{array} \quad \begin{array}{l} (-) \\ \\ \end{array}$$

Substituting  $x = 1$  in (4),  $5 + y = 7 \Rightarrow y = 2$

Substituting  $x = 1, y = 2$  in (3),  $1 + 2 + z = 6$  we get,  $z = 3$

Therefore,  $x = 1, y = 2, z = 3$

**Example 3.4** In an interschool athletic meet, with total of 24 individual prices, securing a total of 56 points, a first place secures 5 points, a second place secures 3 points, and a third place secures 1 point. Having as many third place finishers as first and second place finishers, find how many athletes finished in each place.

**Solution** Let the number of I, II and III place finishers be  $x, y$  and  $z$  respectively.

Total number of events = 24; Total number of points = 56.

Hence, the linear equations in three variables are

$$x + y + z = 24 \dots(1) \quad 5x + 3y + z = 56 \dots(2) \quad x + y = z \dots(3)$$

Substituting (3) in (1) we get,  $z + z = 24 \Rightarrow z = 12$

$\therefore$  (3) will be,  $x + y = 12$

$$\begin{array}{r} (2) \Rightarrow \\ 3 \times (3) \Rightarrow \\ \hline 5x + 3y = 44 \\ 3x + 3y = 36 \\ \hline 2x = 8 \end{array} \quad \begin{array}{l} (-) \\ \\ \text{we get, } x = 4 \end{array}$$

Substituting  $x = 4, z = 12$  in (3) we get,  $y = 12 - 4 = 8$

Therefore, Number of first place finishers is 4

Number of second place finishers is 8

Number of third place finishers is 12.

**Example 3.5** Solve  $x + 2y - z = 5; x - y + z = -2; -5x - 4y + z = -11$

**Solution**  $x + 2y - z = 5 \dots(1) \quad x - y + z = -2 \dots(2) \quad -5x - 4y + z = -11 \dots(3)$

$$\begin{array}{r} \text{Adding (1) and (2) we get,} \\ x + 2y - z = 5 \\ x - y + z = -2 \\ \hline 2x + y = 3 \end{array} \quad \begin{array}{l} (+) \\ \\ \dots(4) \end{array}$$

Subtracting (2) and (3),

$$\begin{array}{r} x - y + z = -2 \\ -5x - 4y + z = -11 \quad (-) \\ \hline 6x + 3y = 9 \end{array}$$

Dividing by 3  $2x + y = 3 \quad \dots(5)$

Subtracting (4) and (5),

$$\begin{array}{r} 2x + y = 3 \\ 2x + y = 3 \\ \hline 0 = 0 \end{array}$$

Here we arrive at an identity  $0=0$ .

Hence the system has an infinite number of solutions.

**Example 3.6** Solve  $3x + y - 3z = 1$ ;  $-2x - y + 2z = 1$ ;  $-x - y + z = 2$ .

**Solution**  $3x + y - 3z = 1 \quad \dots(1) \quad -2x - y + 2z = 1 \quad \dots(2) \quad -x - y + z = 2 \quad \dots(3)$

Adding (1) and (2),

$$\begin{array}{r} 3x + y - 3z = 1 \\ -2x - y + 2z = 1 \quad (+) \\ \hline x - z = 2 \end{array} \quad \dots(4)$$

Adding (1) and (3),

$$\begin{array}{r} 3x + y - 3z = 1 \\ -x - y + z = 2 \quad (+) \\ \hline 2x - 2z = 3 \end{array} \quad \dots(5)$$

Now, (5)  $-2 \times$ (4) we get,

$$\begin{array}{r} 2x - 2z = 3 \\ 2x - 2z = 4 \quad (-) \\ \hline 0 = -1 \end{array}$$

Here we arrive at a contradiction as  $0 \neq -1$ .

This means that the system is inconsistent and has no solution.

**Example 3.7** Solve  $\frac{x}{2} - 1 = \frac{y}{6} + 1 = \frac{z}{7} + 2$ ;  $\frac{y}{3} + \frac{z}{2} = 13$

**Solution** Considering,  $\frac{x}{2} - 1 = \frac{y}{6} + 1$

$$\frac{x}{2} - \frac{y}{6} = 1 + 1 \Rightarrow \frac{6x - 2y}{12} = 2 \text{ we get, } 3x - y = 12 \quad \dots(1)$$

Considering,  $\frac{x}{2} - 1 = \frac{z}{7} + 2$

$$\frac{x}{2} - \frac{z}{7} = 1 + 2 \Rightarrow \frac{7x - 2z}{14} = 3 \text{ we get, } 7x - 2z = 42 \quad \dots(2)$$

Also, from  $\frac{y}{3} + \frac{z}{2} = 13 \Rightarrow \frac{2y + 3z}{6} = 13 \text{ we get, } 2y + 3z = 78 \quad \dots(3)$





Eliminating  $z$  from (2) and (3)

$$\begin{array}{rcl}
 (2) \times 3 \Rightarrow & 21x & -6z = 126 \\
 (3) \times 2 \Rightarrow & & 4y + 6z = 156 \quad (+) \\
 \hline
 & 21x + 4y & = 282 \\
 (1) \times 4 \Rightarrow & 12x - 4y & = 48 \quad (+) \\
 \hline
 & 33x & = 330 \quad \text{so, } x = 10
 \end{array}$$

Substituting  $x = 10$  in (1),  $30 - y = 12$  we get,  $y = 18$

Substituting  $x = 10$  in (2),  $70 - 2z = 42$  then,  $z = 14$

$\therefore x = 10, y = 18, z = 14.$

**Example 3.8** Solve :  $\frac{1}{2x} + \frac{1}{4y} - \frac{1}{3z} = \frac{1}{4}$  ;  $\frac{1}{x} = \frac{1}{3y}$  ;  $\frac{1}{x} - \frac{1}{5y} + \frac{4}{z} = 2\frac{2}{15}$

**Solution** Let  $\frac{1}{x} = p$ ,  $\frac{1}{y} = q$ ,  $\frac{1}{z} = r$

The given equations are written as

$$\begin{aligned}
 \frac{p}{2} + \frac{q}{4} - \frac{r}{3} &= \frac{1}{4} \\
 p &= \frac{q}{3} \\
 p - \frac{q}{5} + 4r &= 2\frac{2}{15} = \frac{32}{15}
 \end{aligned}$$

By simplifying we get,

$$6p + 3q - 4r = 3 \quad \dots(1)$$

$$3p = q \quad \dots(2)$$

$$15p - 3q + 60r = 32 \quad \dots(3)$$

Substituting (2) in (1) and (3) we get,

$$15p - 4r = 3 \quad \dots(4)$$

$$6p + 60r = 32 \text{ reduces to } 3p + 30r = 16 \quad \dots(5)$$

Solving (4) and (5),

$$\begin{array}{rcl}
 15p - 4r & = & 3 \\
 15p + 150r & = & 80 \quad (-) \\
 \hline
 -154r & = & -77 \quad \text{we get, } r = \frac{1}{2}
 \end{array}$$

Substituting  $r = \frac{1}{2}$  in (4) we get,  $15p - 2 = 3 \Rightarrow p = \frac{1}{3}$

From (2),  $q = 3p$  we get  $q = 1$

Therefore,  $x = \frac{1}{p} = 3$ ,  $y = \frac{1}{q} = 1$ ,  $z = \frac{1}{r} = 2$ . i.e.,  $x = 3, y = 1, z = 2.$

**Example 3.9** The sum of thrice the first number, second number and twice the third number is 5. If thrice the second number is subtracted from the sum of first number and thrice the third we get 2. If the third number is subtracted from the sum of twice the first, thrice the second, we get 1. Find the numbers.

**Solution** Let the three numbers be  $x, y, z$

From the given data we get the following equations,

$$3x + y + 2z = 5 \dots(1) \quad x + 3z - 3y = 2 \quad \dots(2) \quad 2x + 3y - z = 1 \dots(3)$$

$$(1) \times 1 \Rightarrow 3x + y + 2z = 5$$

$$(2) \times 3 \Rightarrow 3x - 9y + 9z = 6 \quad (-)$$

$$\hline 10y - 7z = -1 \quad \dots(4)$$

$$(1) \times 2 \Rightarrow 6x + 2y + 4z = 10$$

$$(3) \times 3 \Rightarrow 6x + 9y - 3z = 3 \quad (-)$$

$$\hline -7y + 7z = 7 \quad \dots(5)$$

Adding (4) and (5),  $10y - 7z = -1$

$$-7y + 7z = 7$$

$$\hline 3y = 6 \Rightarrow y = 2$$

Substituting  $y = 2$  in (5),  $-14 + 7z = 7 \Rightarrow z = 3$

Substituting  $y = 2$  and  $z = 3$  in (1),

$$3x + 2 + 6 = 5 \text{ we get } x = -1$$

Therefore,  $x = -1, y = 2, z = 3$ .

### Thinking Corner

- The number of possible solutions when solving system of linear equations in three variables are \_\_\_\_\_.
- If three planes are parallel then the number of possible point(s) of intersection is/are \_\_\_\_\_.



### Progress Check

- For a system of linear equations in three variables the minimum number of equations required to get unique solution is \_\_\_\_\_.
- A system with \_\_\_\_\_ will reduce to identity.
- A system with \_\_\_\_\_ will provide absurd equation.



### Exercise 3.1

1. Solve the following system of linear equations in three variables

(i)  $x + y + z = 5; 2x - y + z = 9; x - 2y + 3z = 16$

(ii)  $\frac{1}{x} - \frac{2}{y} + 4 = 0; \frac{1}{y} - \frac{1}{z} + 1 = 0; \frac{2}{z} + \frac{3}{x} = 14$

(iii)  $x + 20 = \frac{3y}{2} + 10 = 2z + 5 = 110 - (y + z)$

2. Discuss the nature of solutions of the following system of equations
- (i)  $x + 2y - z = 6$ ;  $-3x - 2y + 5z = -12$ ;  $x - 2z = 3$
- (ii)  $2y + z = 3(-x + 1)$ ;  $-x + 3y - z = -4$ ;  $3x + 2y + z = -\frac{1}{2}$
- (iii)  $\frac{y+z}{4} = \frac{z+x}{3} = \frac{x+y}{2}$ ;  $x + y + z = 27$
3. Vani, her father and her grand father have an average age of 53. One-half of her grand father's age plus one-third of her father's age plus one fourth of Vani's age is 65. Four years ago if Vani's grandfather was four times as old as Vani then how old are they all now ?
4. The sum of the digits of a three-digit number is 11. If the digits are reversed, the new number is 46 more than five times the former number. If the hundreds digit plus twice the tens digit is equal to the units digit, then find the original three digit number ?
5. There are 12 pieces of five, ten and twenty rupee currencies whose total value is ₹105. When first 2 sorts are interchanged in their numbers its value will be increased by ₹20. Find the number of currencies in each sort.

### 3.3 GCD and LCM of Polynomials

#### 3.3.1 Greatest Common Divisor (GCD) or Highest Common Factor (HCF) of Polynomials

In our previous class we have learnt how to find the GCD (HCF) of second degree and third degree expressions by the method of factorization. Now we shall learn how to find the GCD of the given polynomials by the method of long division.

As discussed in Chapter 2, (Numbers and Sequences) to find GCD of two positive integers using Euclidean Algorithm, similar techniques can be employed for two given polynomials also.

The following procedure gives a systematic way of finding **Greatest Common Divisor** of two given polynomials  $f(x)$  and  $g(x)$ .

**Step 1:** First, divide  $f(x)$  by  $g(x)$  to obtain  $f(x) = g(x)q(x) + r(x)$  where  $q(x)$  is the quotient and  $r(x)$  is the remainder. Then,  $\deg[r(x)] < \deg[g(x)]$

**Step 2:** If the remainder  $r(x)$  is non-zero, divide  $g(x)$  by  $r(x)$  to obtain  $g(x) = r(x)q_1(x) + r_1(x)$  where  $r_1(x)$  is the new remainder. Then  $\deg[r_1(x)] < \deg[r(x)]$ . If the remainder  $r_1(x)$  is zero, then  $r(x)$  is the required GCD.

**Step 3:** If  $r_1(x)$  is non-zero, then continue the process until we get zero as remainder. The divisor at this stage will be the required GCD.

We write  $GCD[f(x), g(x)]$  to denote the GCD of the polynomials  $f(x), g(x)$ .

#### Note



If  $f(x)$  and  $g(x)$  are two polynomials of same degree then the polynomial carrying the highest coefficient will be the dividend. In case, if both have the same coefficient then compare the next least degree's coefficient and proceed with the division.



## Progress Check

1. When two polynomials of same degree has to be divided, \_\_\_\_\_ should be considered to fix the dividend and divisor.
2. If  $r(x) = 0$  when  $f(x)$  is divided by  $g(x)$  then  $g(x)$  is called \_\_\_\_\_ of the polynomials.
3. If  $f(x) = g(x)q(x) + r(x)$ , \_\_\_\_\_ must be added to  $f(x)$  to make  $f(x)$  completely divisible by  $g(x)$ .
4. If  $f(x) = g(x)q(x) + r(x)$ , \_\_\_\_\_ must be subtracted to  $f(x)$  to make  $f(x)$  completely divisible by  $g(x)$ .

**Example 3.10** Find the GCD of the polynomials  $x^3 + x^2 - x + 2$  and  $2x^3 - 5x^2 + 5x - 3$ .

**Solution** Let  $f(x) = 2x^3 - 5x^2 + 5x - 3$  and  $g(x) = x^3 + x^2 - x + 2$

$$\begin{array}{r}
 2 \\
 \hline
 x^3 + x^2 - x + 2 \quad \begin{array}{l} 2x^3 - 5x^2 + 5x - 3 \\ 2x^3 + 2x^2 - 2x + 4 \end{array} \quad (-) \\
 \hline
 -7x^2 + 7x - 7 \\
 \hline
 = -7(x^2 - x + 1)
 \end{array}$$

$-7(x^2 - x + 1) \neq 0$ , note that  $-7$  is not a divisor of  $g(x)$

Now dividing  $g(x) = x^3 + x^2 - x + 2$  by the new remainder  $x^2 - x + 1$  (leaving the constant factor), we get

$$\begin{array}{r}
 x + 2 \\
 \hline
 x^2 - x + 1 \quad \begin{array}{l} x^3 + x^2 - x + 2 \\ x^3 - x^2 + x \end{array} \quad (-) \\
 \hline
 2x^2 - 2x + 2 \\
 \hline
 2x^2 - 2x + 2 \quad (-) \\
 \hline
 0
 \end{array}$$

Here, we get zero remainder.

Therefore,  $\text{GCD}(2x^3 - 5x^2 + 5x - 3, x^3 + x^2 - x + 2) = x^2 - x + 1$ .

**Example 3.11** Find the GCD of  $6x^3 - 30x^2 + 60x - 48$  and  $3x^3 - 12x^2 + 21x - 18$ .

**Solution** Let,  $f(x) = 6x^3 - 30x^2 + 60x - 48 = 6(x^3 - 5x^2 + 10x - 8)$  and  
 $g(x) = 3x^3 - 12x^2 + 21x - 18 = 3(x^3 - 4x^2 + 7x - 6)$

Now, we shall find the GCD of  $x^3 - 5x^2 + 10x - 8$  and  $x^3 - 4x^2 + 7x - 6$

$$\begin{array}{r}
 1 \\
 \hline
 x^3 - 5x^2 + 10x - 8 \quad \left| \begin{array}{l} x^3 - 4x^2 + 7x - 6 \\ x^3 - 5x^2 + 10x - 8 \end{array} \right. \quad (-) \\
 \hline
 x^2 - 3x + 2
 \end{array}$$

$$\begin{array}{r}
 x - 2 \\
 \hline
 x^2 - 3x + 2 \quad \left| \begin{array}{l} x^3 - 5x^2 + 10x - 8 \\ x^3 - 3x^2 + 2x \end{array} \right. \quad (-) \\
 \hline
 -2x^2 + 8x - 8 \\
 -2x^2 + 6x - 4 \quad (-) \\
 \hline
 2x - 4 \\
 = 2(x - 2)
 \end{array}$$

$$\begin{array}{r}
 x - 1 \\
 \hline
 x - 2 \quad \left| \begin{array}{l} x^2 - 3x + 2 \\ x^2 - 2x \end{array} \right. \quad (-) \\
 \hline
 -x + 2 \\
 -x + 2 \quad (-) \\
 \hline
 0
 \end{array}$$

Here, we get zero as remainder.

GCD of leading coefficients 3 and 6 is 3.

Thus,  $\text{GCD} \left[ (6x^3 - 30x^2 + 60x - 48, 3x^3 - 12x^2 + 21x - 18) \right] = 3(x - 2)$ .

### 3.3.2 Least Common Multiple (LCM) of Polynomials

The **Least Common Multiple** of two or more algebraic expressions is the expression of highest degree (or power) such that the expressions exactly divide it.

Consider the following simple expressions  $a^3b^2$ ,  $a^2b^3$ .

For these expressions  $LCM = a^3b^3$ .

To find LCM by factorization method

- (i) Each expression is first resolved into its factors.
- (ii) The highest power of the factors will be the LCM.
- (iii) If the expressions have numerical coefficients, find their LCM.
- (iv) The product of the LCM of factors and coefficient is the required LCM.

**Example 3.12** Find the LCM of the following

(i)  $8x^4y^2$ ,  $48x^2y^4$

(ii)  $5x - 10$ ,  $5x^2 - 20$

(iii)  $x^4 - 1$ ,  $x^2 - 2x + 1$

(iv)  $x^3 - 27$ ,  $(x - 3)^2$ ,  $x^2 - 9$

**Solution** (i)  $8x^4y^2, 48x^2y^4$

First let us find the LCM of the numerical coefficients.

That is,  $\text{LCM}(8, 48) = 2 \times 2 \times 2 \times 6 = 48$

Then find the LCM of the terms involving variables.

That is,  $\text{LCM}(x^4y^2, x^2y^4) = x^4y^4$

Finally find the LCM of the given expression.

We conclude that the LCM of the given expression is the product of the LCM of the numerical coefficient and the LCM of the terms with variables.

Therefore,  $\text{LCM}(8x^4y^2, 48x^2y^4) = 48x^4y^4$

(ii)  $(5x - 10), (5x^2 - 20)$

$$5x - 10 = 5(x - 2)$$

$$5x^2 - 20 = 5(x^2 - 4) = 5(x + 2)(x - 2)$$

Therefore,  $\text{LCM}[(5x - 10), (5x^2 - 20)] = 5(x + 2)(x - 2)$

(iii)  $(x^4 - 1), x^2 - 2x + 1$

$$x^4 - 1 = (x^2)^2 - 1 = (x^2 + 1)(x^2 - 1) = (x^2 + 1)(x + 1)(x - 1)$$

$$x^2 - 2x + 1 = (x - 1)^2$$

Therefore,  $\text{LCM}[(x^4 - 1), (x^2 - 2x + 1)] = (x^2 + 1)(x + 1)(x - 1)^2$

(iv)  $x^3 - 27, (x - 3)^2, x^2 - 9$

$$x^3 - 27 = (x - 3)(x^2 + 3x + 9); (x - 3)^2 = (x - 3)^2; (x^2 - 9) = (x + 3)(x - 3)$$

Therefore,  $\text{LCM}[(x^3 - 27), (x - 3)^2, (x^2 - 9)] = (x - 3)^2(x + 3)(x^2 + 3x + 9)$

### Thinking Corner



Complete the factor tree for the given polynomials  $f(x)$  and  $g(x)$ . Hence find their GCD and LCM.

$$f(x) = 2x^3 - 9x^2 - 32x - 21$$

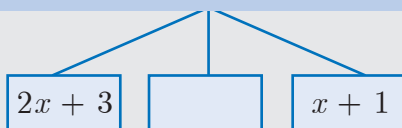

$$g(x) = 2x^3 - 7x^2 - 43x - 42$$



GCD [ $f(x)$  and  $g(x)$ ] = \_\_\_\_\_

LCM [ $f(x)$  and  $g(x)$ ] = \_\_\_\_\_



### Exercise 3.2

1. Find the GCD of the given polynomials

(i)  $x^4 + 3x^3 - x - 3, x^3 + x^2 - 5x + 3$

(ii)  $x^4 - 1, x^3 - 11x^2 + x - 11$

(iii)  $3x^4 + 6x^3 - 12x^2 - 24x, 4x^4 + 14x^3 + 8x^2 - 8x$

(iv)  $3x^3 + 3x^2 + 3x + 3, 6x^3 + 12x^2 + 6x + 12$

2. Find the LCM of the given expressions.

- (i)  $4x^2y, 8x^3y^2$                       (ii)  $9a^3b^2, 12a^2b^2c$                       (iii)  $16m, 12m^2n^2, 8n^2$   
 (iv)  $p^2 - 3p + 2, p^2 - 4$                       (v)  $2x^2 - 5x - 3, 4x^2 - 36$   
 (vi)  $(2x^2 - 3xy)^2, (4x - 6y)^3, 8x^3 - 27y^3$

### 3.3.3 Relationship between LCM and GCD

Let us consider two numbers 12 and 18.

We observe that,  $LCM(12,18) = 36, GCD(12,18) = 6$ .

Now,  $LCM(12,18) \times GCD(12,18) = 36 \times 6 = 216 = 12 \times 18$

Thus  $LCM \times GCD$  is equal to the product of two given numbers.

Similarly, the product of two polynomials is the product of their LCM and GCD, That is,  $f(x) \times g(x) = LCM[f(x), g(x)] \times GCD[f(x), g(x)]$

#### Illustration

Consider

$$f(x) = 12(x^2 - y^2) \text{ and } g(x) = 8(x^3 - y^3)$$

Now

$$f(x) = 12(x^2 - y^2) = 2^2 \times 3 \times (x + y)(x - y) \quad \dots(1)$$

and

$$g(x) = 8(x^3 - y^3) = 2^3 \times (x - y)(x^2 + xy + y^2) \quad \dots(2)$$

From (1) and (2) we get,

$$\begin{aligned} LCM[f(x), g(x)] &= 2^3 \times 3 \times (x + y)(x - y)(x^2 + xy + y^2) \\ &= 24 \times (x^2 - y^2)(x^2 + xy + y^2) \end{aligned}$$

$$GCD[f(x), g(x)] = 2^2 \times (x - y) = 4(x - y)$$

$$LCM \times GCD = 24 \times 4 \times (x^2 - y^2) \times (x^2 + xy + y^2) \times (x - y)$$

$$LCM \times GCD = 96(x^3 - y^3)(x^2 - y^2) \quad \dots(3)$$

product of  $f(x)$  and  $g(x) = 12(x^2 - y^2) \times 8(x^3 - y^3)$

$$= 96(x^2 - y^2)(x^3 - y^3) \quad \dots(4)$$

From (3) and (4) we obtain  $LCM \times GCD = f(x) \times g(x)$

#### Thinking Corner

Is  $f(x) \times g(x) \times r(x) = LCM[f(x), g(x), r(x)] \times GCD[f(x), g(x), r(x)]$  ?



#### Exercise 3.3

- Find the LCM and GCD for the following and verify that  $f(x) \times g(x) = LCM \times GCD$ 
  - $21x^2y, 35xy^2$
  - $(x^3 - 1)(x + 1), (x^3 + 1)$
  - $(x^2y + xy^2), (x^2 + xy)$
- Find the LCM of each pair of the following polynomials
  - $a^2 + 4a - 12, a^2 - 5a + 6$  whose  $GCD$  is  $a - 2$
  - $x^4 - 27a^3x, (x - 3a)^2$  whose  $GCD$  is  $(x - 3a)$

3. Find the GCD of each pair of the following polynomials
- (i)  $12(x^4 - x^3)$ ,  $8(x^4 - 3x^3 + 2x^2)$  whose LCM is  $24x^3(x-1)(x-2)$
- (ii)  $(x^3 + y^3)$ ,  $(x^4 + x^2y^2 + y^4)$  whose LCM is  $(x^3 + y^3)(x^2 + xy + y^2)$
4. Given the LCM and GCD of the two polynomials  $p(x)$  and  $q(x)$  find the unknown polynomial in the following table

S.No.	LCM	GCD	$p(x)$	$q(x)$
(i)	$a^3 - 10a^2 + 11a + 70$	$a - 7$	$a^2 - 12a + 35$	
(ii)	$(x^4 - y^4)(x^4 + x^2y^2 + y^4)$	$(x^2 - y^2)$		$(x^4 - y^4)(x^2 + y^2 - xy)$

### 3.4 Rational Expressions

**Definition :** An expression is called a rational expression if it can be written in the form  $\frac{p(x)}{q(x)}$  where  $p(x)$  and  $q(x)$  are polynomials and  $q(x) \neq 0$ . A **rational expression** is the ratio of two polynomials.

The following are examples of rational expressions.

$$\frac{9}{x}, \frac{2y+1}{y^2-4y+9}, \frac{z^3+5}{z-4}, \frac{a}{a+10}$$

The rational expressions are applied for describing distance-time, modeling multi-task problems, to combine workers or machines to complete a job schedule and much more.

#### 3.4.1 Reduction of Rational Expression

A rational expression  $\frac{p(x)}{q(x)}$  is said to be in its lowest form if  $GCD(p(x), q(x)) = 1$ .

To reduce a rational expression to its lowest form, follow the given steps

- Factorize the numerator and the denominator
- If there are common factors in the numerator and denominator, cancel them.
- The resulting expression will be a rational expression in its lowest form.

**Example 3.13** Reduce the rational expressions to its lowest form

$$(i) \frac{x-3}{x^2-9} \quad (ii) \frac{x^2-16}{x^2+8x+16}$$

**Solution** (i)  $\frac{x-3}{x^2-9} = \frac{x-3}{(x+3)(x-3)} = \frac{1}{x+3}$

(ii)  $\frac{x^2-16}{x^2+8x+16} = \frac{(x+4)(x-4)}{(x+4)^2} = \frac{x-4}{x+4}$



#### 3.4.2 Excluded Value

A value that makes a rational expression  $\frac{p(x)}{q(x)}$  (in its lowest form) undefined is called an **Excluded value**.



To find excluded value for a given rational expression in its lowest form, say  $\frac{p(x)}{q(x)}$ , consider the denominator  $q(x) = 0$ .

For example, the rational expression  $\frac{5}{x-10}$  is undefined when  $x = 10$ . So, 10 is called an excluded value for  $\frac{5}{x-10}$ .

**Example 3.14** Find the excluded values of the following expressions (if any).

(i)  $\frac{x+10}{8x}$       (ii)  $\frac{7p+2}{8p^2+13p+5}$       (iii)  $\frac{x}{x^2+1}$

**Solution**

(i)  $\frac{x+10}{8x}$

The expression  $\frac{x+10}{8x}$  is undefined when  $8x = 0$  or  $x = 0$ . Hence the excluded value is 0.

(ii)  $\frac{7p+2}{8p^2+13p+5}$

The expression  $\frac{7p+2}{8p^2+13p+5}$  is undefined when  $8p^2+13p+5 = 0$   
that is,  $(8p+5)(p+1) = 0$

$p = \frac{-5}{8}$ ,  $p = -1$ . The excluded values are  $\frac{-5}{8}$  and  $-1$ .

(iii)  $\frac{x}{x^2+1}$

Here  $x^2 \geq 0$  for all  $x$ . Therefore,  $x^2 + 1 \geq 0 + 1 = 1$ . Hence,  $x^2 + 1 \neq 0$  for any  $x$ .  
Therefore, there can be no real excluded values for the given rational expression  $\frac{x}{x^2+1}$ .

### Thinking Corner

1. Are  $x^2 - 1$  and  $\tan x = \frac{\sin x}{\cos x}$  rational expressions?

2. The number of excluded values of  $\frac{x^3 + x^2 - 10x + 8}{x^4 + 8x^2 - 9}$  is \_\_\_\_\_.



### Exercise 3.4

1. Reduce each of the following rational expressions to its lowest form.

(i)  $\frac{x^2-1}{x^2+x}$       (ii)  $\frac{x^2-11x+18}{x^2-4x+4}$       (iii)  $\frac{9x^2+81x}{x^3+8x^2-9x}$       (iv)  $\frac{p^2-3p-40}{2p^3-24p^2+64p}$

2. Find the excluded values, if any of the following expressions.

(i)  $\frac{y}{y^2-25}$       (ii)  $\frac{t}{t^2-5t+6}$       (iii)  $\frac{x^2+6x+8}{x^2+x-2}$       (iv)  $\frac{x^3-27}{x^3+x^2-6x}$

### 3.4.3 Operations of Rational Expressions

We have studied the concepts of addition, subtraction, multiplication and division of rational numbers in previous classes. Now let us generalize the above for rational expressions.

#### Multiplication of Rational Expressions

If  $\frac{p(x)}{q(x)}$  and  $\frac{r(x)}{s(x)}$  are two rational expressions where  $q(x) \neq 0$ ,  $s(x) \neq 0$ ,

$$\text{their product is } \frac{p(x)}{q(x)} \times \frac{r(x)}{s(x)} = \frac{p(x) \times r(x)}{q(x) \times s(x)}$$

In other words, the product of two rational expression is the product of their numerators divided by the product of their denominators and the resulting expression is then reduced to its lowest form.

#### Division of Rational Expressions

If  $\frac{p(x)}{q(x)}$  and  $\frac{r(x)}{s(x)}$  are two rational expressions, where  $q(x), s(x) \neq 0$  then,

$$\frac{p(x)}{q(x)} \div \frac{r(x)}{s(x)} = \frac{p(x)}{q(x)} \times \frac{s(x)}{r(x)} = \frac{p(x) \times s(x)}{q(x) \times r(x)}$$

Thus division of one rational expression by other is equivalent to the product of first and reciprocal of the second expression. If the resulting expression is not in its lowest form then reduce to its lowest form.



#### Progress Check

Find the unknown expression in the following figures.

1.

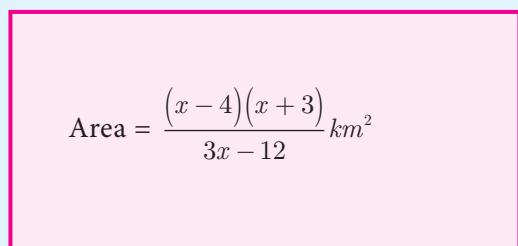

breadth = ?

$$\text{length} = \frac{x-3}{3} \text{ km}$$

Fig. 3.5

2.

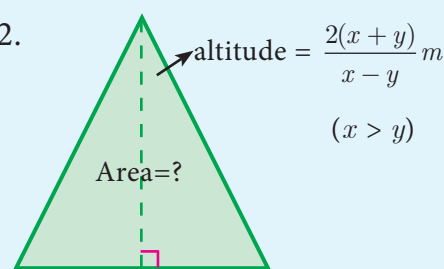

$$(x > y)$$

Fig. 3.6

**Example 3.15** (i) Multiply  $\frac{x^3}{9y^2}$  by  $\frac{27y}{x^5}$  (ii) Multiply  $\frac{x^4b^2}{x-1}$  by  $\frac{x^2-1}{a^4b^3}$

**Solution** (i)  $\frac{x^3}{9y^2} \times \frac{27y}{x^5} = \frac{3}{x^2y}$  (ii)  $\frac{x^4b^2}{x-1} \times \frac{x^2-1}{a^4b^3} = \frac{x^4 \times b^2}{x-1} \times \frac{(x+1)(x-1)}{a^4 \times b^3} = \frac{x^4(x+1)}{a^4b}$

**Example 3.16** Find

$$(i) \frac{14x^4}{y} \sqrt{\frac{7x}{3y^4}} \quad (ii) \frac{x^2-16}{x+4} \div \frac{x-4}{x+4} \quad (iii) \frac{16x^2-2x-3}{3x^2-2x-1} \div \frac{8x^2+11x+3}{3x^2-11x-4}$$

**Solution :**

(i)  $\frac{14x^4}{y} \sqrt{\frac{7x}{3y^4}} = \frac{14x^4}{y} \times \frac{3y^4}{7x} = 6x^3y^3$

(ii)  $\frac{x^2 - 16}{x + 4} \div \frac{x - 4}{x + 4} = \frac{(x + 4)(x - 4)}{(x + 4)} \times \left(\frac{x + 4}{x - 4}\right) = x + 4$

(iii)  $\frac{16x^2 - 2x - 3}{3x^2 - 2x - 1} \div \frac{8x^2 + 11x + 3}{3x^2 - 11x - 4} = \frac{16x^2 - 2x - 3}{3x^2 - 2x - 1} \times \frac{3x^2 - 11x - 4}{8x^2 + 11x + 3}$   
 $= \frac{(8x + 3)(2x - 1)}{(3x + 1)(x - 1)} \times \frac{(3x + 1)(x - 4)}{(8x + 3)(x + 1)} = \frac{(2x - 1)(x - 4)}{(x - 1)(x + 1)} = \frac{2x^2 - 9x + 4}{x^2 - 1}$

**Exercise 3.5**

1. Simplify

(i)  $\frac{4x^2y}{2z^2} \times \frac{6xz^3}{20y^4}$       (ii)  $\frac{p^2 - 10p + 21}{p - 7} \times \frac{p^2 + p - 12}{(p - 3)^2}$       (iii)  $\frac{5t^3}{4t - 8} \times \frac{6t - 12}{10t}$

2. Simplify

(i)  $\frac{x + 4}{3x + 4y} \times \frac{9x^2 - 16y^2}{2x^2 + 3x - 20}$       (ii)  $\frac{x^3 - y^3}{3x^2 + 9xy + 6y^2} \times \frac{x^2 + 2xy + y^2}{x^2 - y^2}$

3. Simplify

(i)  $\frac{2a^2 + 5a + 3}{2a^2 + 7a + 6} \div \frac{a^2 + 6a + 5}{-5a^2 - 35a - 50}$       (ii)  $\frac{b^2 + 3b - 28}{b^2 + 4b + 4} \div \frac{b^2 - 49}{b^2 - 5b - 14}$

(iii)  $\frac{x + 2}{4y} \div \frac{x^2 - x - 6}{12y^2}$       (iv)  $\frac{12t^2 - 22t + 8}{3t} \div \frac{3t^2 + 2t - 8}{2t^2 + 4t}$

4. If  $x = \frac{a^2 + 3a - 4}{3a^2 - 3}$  and  $y = \frac{a^2 + 2a - 8}{2a^2 - 2a - 4}$  find the value of  $x^2y^{-2}$ .5. If a polynomial  $p(x) = x^2 - 5x - 14$  is divided by another polynomial  $q(x)$  we get  $\frac{x - 7}{x + 2}$ , find  $q(x)$ .**Activity 1**

(i) The length of a rectangular garden is the sum of a number and its reciprocal. The breadth is the difference of the square of the same number and its reciprocal. Find the length, breadth and the ratio of the length to the breadth of the rectangle.

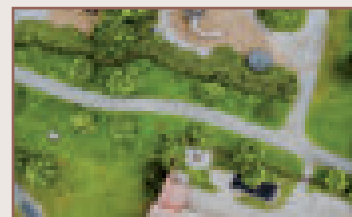

(ii) Find the ratio of the perimeter to the area of the given triangle.

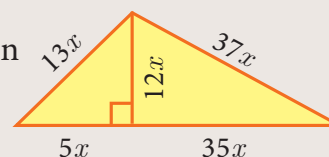

## Addition and Subtraction of Rational Expressions

### Addition and Subtraction of Rational Expressions with Like Denominators

- Add or Subtract the numerators
- Write the sum or difference of the numerators found in step (i) over the common denominator.
- Reduce the resulting rational expression into its lowest form.

**Example 3.17** Find  $\frac{x^2 + 20x + 36}{x^2 - 3x - 28} - \frac{x^2 + 12x + 4}{x^2 - 3x - 28}$

**Solution**

$$\frac{x^2 + 20x + 36}{x^2 - 3x - 28} - \frac{x^2 + 12x + 4}{x^2 - 3x - 28} = \frac{(x^2 + 20x + 36) - (x^2 + 12x + 4)}{x^2 - 3x - 28}$$

$$= \frac{8x + 32}{x^2 - 3x - 28} = \frac{8(x + 4)}{(x - 7)(x + 4)} = \frac{8}{x - 7}$$

### Addition and Subtraction of Rational Expressions with unlike Denominators

- Determine the Least Common Multiple of the denominator.
- Rewrite each fraction as an equivalent fraction with the LCM obtained in step (i). This is done by multiplying both the numerators and denominator of each expression by any factors needed to obtain the LCM.
- Follow the same steps given for doing addition or subtraction of the rational expression with like denominators.



#### Progress Check

- Write an expression that represents the perimeter of the figure and simplify.

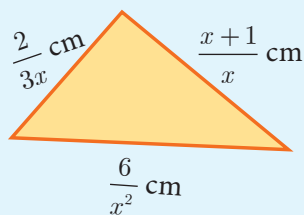

- Find the base of the given parallelogram whose perimeter is  $\frac{4x^2 + 10x - 50}{(x - 3)(x + 5)}$

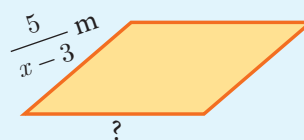

**Example 3.18** Simplify  $\frac{1}{x^2 - 5x + 6} + \frac{1}{x^2 - 3x + 2} - \frac{1}{x^2 - 8x + 15}$

**Solution**

$$\frac{1}{x^2 - 5x + 6} + \frac{1}{x^2 - 3x + 2} - \frac{1}{x^2 - 8x + 15}$$

$$= \frac{1}{(x - 2)(x - 3)} + \frac{1}{(x - 2)(x - 1)} - \frac{1}{(x - 5)(x - 3)}$$

$$= \frac{(x - 1)(x - 5) + (x - 3)(x - 5) - (x - 1)(x - 2)}{(x - 1)(x - 2)(x - 3)(x - 5)}$$

$$= \frac{(x^2 - 6x + 5) + (x^2 - 8x + 15) - (x^2 - 3x + 2)}{(x - 1)(x - 2)(x - 3)(x - 5)}$$

#### Thinking Corner

##### Say True or False

- The sum of two rational expressions is always a rational expression.
- The product of two rational expressions is always a rational expression.

$$= \frac{x^2 - 11x + 18}{(x-1)(x-2)(x-3)(x-5)} = \frac{(x-9)(x-2)}{(x-1)(x-2)(x-3)(x-5)}$$

$$= \frac{x-9}{(x-1)(x-3)(x-5)}$$



### Exercise 3.6

- Simplify (i)  $\frac{x(x+1)}{x-2} + \frac{x(1-x)}{x-2}$  (ii)  $\frac{x+2}{x+3} + \frac{x-1}{x-2}$  (iii)  $\frac{x^3}{x-y} + \frac{y^3}{y-x}$
- Simplify (i)  $\frac{(2x+1)(x-2)}{x-4} - \frac{(2x^2-5x+2)}{x-4}$  (ii)  $\frac{4x}{x^2-1} - \frac{x+1}{x-1}$
- Subtract  $\frac{1}{x^2+2}$  from  $\frac{2x^3+x^2+3}{(x^2+2)^2}$
- Which rational expression should be subtracted from  $\frac{x^2+6x+8}{x^3+8}$  to get  $\frac{3}{x^2-2x+4}$
- If  $A = \frac{2x+1}{2x-1}$ ,  $B = \frac{2x-1}{2x+1}$  find  $\frac{1}{A-B} - \frac{2B}{A^2-B^2}$
- If  $A = \frac{x}{x+1}$ ,  $B = \frac{1}{x+1}$ , prove that  $\frac{(A+B)^2 + (A-B)^2}{A \div B} = \frac{2(x^2+1)}{x(x+1)^2}$
- Pari needs 4 hours to complete a work. His friend Yuvan needs 6 hours to complete the same work. How long will it take to complete if they work together?
- Iniya bought 50 kg of fruits consisting of apples and bananas. She paid twice as much per kg for the apple as she did for the banana. If Iniya bought ₹ 1800 worth of apples and ₹ 600 worth bananas, then how many kgs of each fruit did she buy?

### 3.5 Square Root of Polynomials

The **square root** of a given positive real number is another number which when multiplied with itself is the given number.

Similarly, the square root of a given expression  $p(x)$  is another expression  $q(x)$  which when multiplied by itself gives  $p(x)$ , that is,  $q(x)$ .  $q(x) = p(x)$

So,  $|q(x)| = \sqrt{p(x)}$  where  $|q(x)|$  is the absolute value of  $q(x)$ .

The following two methods are used to find the square root of a given expression

- (i) Factorization method (ii) Division method



#### Progress Check

- Is  $x^2 + 4x + 4$  a perfect square?
- What is the value of  $x$  in  $3\sqrt{x} = 9$ ?
- The square root of  $361x^4y^2$  is \_\_\_\_\_.
- $\sqrt{a^2x^2 + 2abx + b^2} = \text{_____}$ .
- If a polynomial is a perfect square then, its factors will be repeated \_\_\_\_\_ number of times (odd / even).

### 3.5.1 Find the Square Root by Factorization Method

**Example 3.19** Find the square root of the following expressions

$$(i) 256(x-a)^8(x-b)^4(x-c)^{16}(x-d)^{20} \quad (ii) \frac{144 a^8 b^{12} c^{16}}{81 f^{12} g^4 h^{14}}$$

**Solution** (i)  $\sqrt{256(x-a)^8(x-b)^4(x-c)^{16}(x-d)^{20}} = 16|(x-a)^4(x-b)^2(x-c)^8(x-d)^{10}|$   
 (ii)  $\sqrt{\frac{144a^8b^{12}c^{16}}{81f^{12}g^4h^{14}}} = \frac{4}{3} \left| \frac{a^4b^6c^8}{f^6g^2h^7} \right|$

**Example 3.20** Find the square root of the following expressions

$$(i) 16x^2 + 9y^2 - 24xy + 24x - 18y + 9 \quad (ii) (6x^2 + x - 1)(3x^2 + 2x - 1)(2x^2 + 3x + 1)$$

$$(iii) \left[ \sqrt{15x^2 + (\sqrt{3} + \sqrt{10})x + \sqrt{2}} \right] \left[ \sqrt{5x^2 + (2\sqrt{5} + 1)x + 2} \right] \left[ \sqrt{3x^2 + (\sqrt{2} + 2\sqrt{3})x + 2\sqrt{2}} \right]$$

**Solution** (i)  $\sqrt{16x^2 + 9y^2 - 24xy + 24x - 18y + 9}$

$$= \sqrt{(4x)^2 + (-3y)^2 + (3)^2 + 2(4x)(-3y) + 2(-3y)(3) + 2(4x)(3)}$$

$$= \sqrt{(4x - 3y + 3)^2} = |4x - 3y + 3|$$

(ii)  $\sqrt{(6x^2 + x - 1)(3x^2 + 2x - 1)(2x^2 + 3x + 1)}$

$$= \sqrt{(3x-1)(2x+1)(3x-1)(x+1)(2x+1)(x+1)} = |(3x-1)(2x+1)(x+1)|$$

(iii) First let us factorize the polynomials

$$\begin{aligned} \sqrt{15x^2 + (\sqrt{3} + \sqrt{10})x + \sqrt{2}} &= \sqrt{15x^2 + \sqrt{3}x + \sqrt{10}x + \sqrt{2}} \\ &= \sqrt{3x(\sqrt{5}x + 1) + \sqrt{2}(\sqrt{5}x + 1)} \\ &= (\sqrt{5}x + 1) \times (\sqrt{3}x + \sqrt{2}) \\ \sqrt{5x^2 + (2\sqrt{5} + 1)x + 2} &= \sqrt{5x^2 + 2\sqrt{5}x + x + 2} \\ &= \sqrt{5x(x+2) + 1(x+2)} = (\sqrt{5}x + 1)(x+2) \\ \sqrt{3x^2 + (\sqrt{2} + 2\sqrt{3})x + 2\sqrt{2}} &= \sqrt{3x^2 + \sqrt{2}x + 2\sqrt{3}x + 2\sqrt{2}} \\ &= x(\sqrt{3}x + \sqrt{2}) + 2(\sqrt{3}x + \sqrt{2}) = (x+2)(\sqrt{3}x + \sqrt{2}) \end{aligned}$$

Therefore,

$$\begin{aligned} &\sqrt{\left[ \sqrt{15x^2 + (\sqrt{3} + \sqrt{10})x + \sqrt{2}} \right] \left[ \sqrt{5x^2 + (2\sqrt{5} + 1)x + 2} \right] \left[ \sqrt{3x^2 + (\sqrt{2} + 2\sqrt{3})x + 2\sqrt{2}} \right]} \\ &= \sqrt{(\sqrt{5}x + 1)(\sqrt{3}x + \sqrt{2})(\sqrt{5}x + 1)(x+2)(\sqrt{3}x + \sqrt{2})(x+2)} = \left| (\sqrt{5}x + 1)(\sqrt{3}x + \sqrt{2})(x+2) \right| \end{aligned}$$



### Exercise 3.7

1. Find the square root of the following rational expressions.

(i)  $\frac{400x^4y^{12}z^{16}}{100x^8y^4z^4}$

(ii)  $\frac{7x^2 + 2\sqrt{14}x + 2}{x^2 - \frac{1}{2}x + \frac{1}{16}}$

(iii)  $\frac{121(a+b)^8(x+y)^8(b-c)^8}{81(b-c)^4(a-b)^{12}(b-c)^4}$

2. Find the square root of the following

(i)  $4x^2 + 20x + 25$

(ii)  $9x^2 - 24xy + 30xz - 40yz + 25z^2 + 16y^2$

(iii)  $(4x^2 - 9x + 2)(7x^2 - 13x - 2)(28x^2 - 3x - 1)$

(iv)  $\left(2x^2 + \frac{17}{6}x + 1\right)\left(\frac{3}{2}x^2 + 4x + 2\right)\left(\frac{4}{3}x^2 + \frac{11}{3}x + 2\right)$

### 3.5.2 Finding the Square Root of a Polynomial by Division Method

The long division method in finding the square root of a polynomial is useful when the degree of the polynomial is higher.

**Example 3.21** Find the square root of  $64x^4 - 16x^3 + 17x^2 - 2x + 1$

**Solution**

$$\begin{array}{r}
 8x^2 - x + 1 \\
 8x^2 \overline{) 64x^4 - 16x^3 + 17x^2 - 2x + 1} \quad (-) \\
 \underline{64x^4} \phantom{- 16x^3 + 17x^2 - 2x + 1} \\
 16x^2 - x \phantom{+ 1} \\
 \underline{-16x^3 + 17x^2} \phantom{- 2x + 1} \quad (-) \\
 \phantom{16x^2 - x} -16x^3 + x^2 \phantom{- 2x + 1} \\
 \underline{-16x^3 + x^2} \phantom{- 2x + 1} \\
 16x^2 - 2x + 1 \\
 \underline{16x^2 - 2x + 1} \quad (-) \\
 0
 \end{array}$$

**Note**



Before proceeding to find the square root of a polynomial, one has to ensure that the degrees of the variables are in descending or ascending order.

Therefore,  $\sqrt{64x^4 - 16x^3 + 17x^2 - 2x + 1} = |8x^2 - x + 1|$

**Example 3.22** If  $9x^4 + 12x^3 + 28x^2 + ax + b$  is a perfect square, find the values of  $a$  and  $b$ .

**Solution**

$$\begin{array}{r}
 3x^2 + 2x + 4 \\
 3x^2 \overline{) 9x^4 + 12x^3 + 28x^2 + ax + b} \quad (-) \\
 \underline{9x^4} \phantom{+ 12x^3 + 28x^2 + ax + b} \\
 6x^2 + 2x \phantom{+ b} \\
 \underline{12x^3 + 28x^2} \phantom{+ ax + b} \quad (-) \\
 \phantom{6x^2 + 2x} 12x^3 + 4x^2 \phantom{+ ax + b} \\
 \underline{12x^3 + 4x^2} \phantom{+ ax + b} \\
 6x^2 + 4x + 4 \phantom{+ b} \\
 \underline{24x^2 + ax + b} \quad (-) \\
 \phantom{6x^2 + 4x + 4} 24x^2 + 16x + 16 \phantom{+ b} \\
 \underline{24x^2 + 16x + 16} \\
 0
 \end{array}$$

Because the given polynomial is a perfect square  $a - 16 = 0$ ,  $b - 16 = 0$   
Therefore  $a = 16$ ,  $b = 16$ .



### Exercise 3.8

- Find the square root of the following polynomials by division method
  - $x^4 - 12x^3 + 42x^2 - 36x + 9$
  - $37x^2 - 28x^3 + 4x^4 + 42x + 9$
  - $16x^4 + 8x^2 + 1$
  - $121x^4 - 198x^3 - 183x^2 + 216x + 144$
- Find the values of  $a$  and  $b$  if the following polynomials are perfect squares
  - $4x^4 - 12x^3 + 37x^2 + bx + a$
  - $ax^4 + bx^3 + 361x^2 + 220x + 100$
- Find the values of  $m$  and  $n$  if the following polynomials are perfect squares
  - $36x^4 - 60x^3 + 61x^2 - mx + n$
  - $x^4 - 8x^3 + mx^2 + nx + 16$

## 3.6 Quadratic Equations

### Introduction

Arab mathematician Abraham bar Hiyya Ha-Nasi, often known by the Latin name Savasorda, is famed for his book 'Liber Embadorum' published in 1145 AD(CE) which is the first book published in Europe to give the complete solution of a quadratic equation.

For a period of more than three thousand years beginning from early civilizations to current times, humanity knew how to solve a general quadratic equation in terms of its co-efficients by using four arithmetical operations and extraction of roots. This process is called "Solving by Radicals". Huge amount of research has been carried to this day in solving various types of equations.

### Quadratic Expression

An expression of degree  $n$  in variable  $x$  is  $a_0x^n + a_1x^{n-1} + a_2x^{n-2} + \dots + a_{n-1}x + a_n$  where  $a_0 \neq 0$  and  $a_1, a_2, \dots, a_n$  are real numbers.  $a_0, a_1, a_2, \dots, a_n$  are called coefficients of the expression.

In particular an expression of degree 2 is called a **Quadratic Expression** which is expressed as  $p(x) = ax^2 + bx + c$ ,  $a \neq 0$  and  $a, b, c$  are real numbers.

#### 3.6.1 Zeroes of a Quadratic Polynomial

Let  $p(x)$  be a polynomial.  $x=a$  is called zero of  $p(x)$  if  $p(a)=0$

For example, if  $p(x)=x^2-2x-8$  then  $p(-2)=4+4-8 = 0$  and  $p(4)= 16- 8 -8 = 0$

Therefore  $-2$  and  $4$  are zeroes of the polynomial  $p(x)=x^2-2x-8$ .





### 3.6.2 Roots of Quadratic Equations

Let  $ax^2 + bx + c = 0$ , ( $a \neq 0$ ) be a quadratic equation. The values of  $x$  such that the expression  $ax^2 + bx + c$  becomes zero are called **roots of the quadratic equation**  $ax^2 + bx + c = 0$ .

We have,  $ax^2 + bx + c = 0$

$$a \left[ x^2 + \frac{b}{a}x + \frac{c}{a} \right] = 0$$

$$x^2 + \frac{b}{a}x + \frac{c}{a} = 0 \quad (\text{since } a \neq 0)$$

$$x^2 + \frac{b}{2a}(2x) + \left(\frac{b}{2a}\right)^2 - \left(\frac{b}{2a}\right)^2 + \frac{c}{a} = 0$$

That is,  $x^2 + (2x)\left(\frac{b}{2a}\right) + \left(\frac{b}{2a}\right)^2 = \frac{b^2}{4a^2} - \frac{c}{a}$

$$\left(x + \frac{b}{2a}\right)^2 = \frac{b^2 - 4ac}{4a^2}$$

$$x + \frac{b}{2a} = \frac{\pm\sqrt{b^2 - 4ac}}{2a}$$

$$x = \frac{-b \pm \sqrt{b^2 - 4ac}}{2a}$$

Therefore, the roots are  $\frac{-b + \sqrt{b^2 - 4ac}}{2a}$  and  $\frac{-b - \sqrt{b^2 - 4ac}}{2a}$



### 3.6.3 Formation of a Quadratic Equation

If  $\alpha$  and  $\beta$  are roots of a quadratic equation  $ax^2 + bx + c = 0$  then

$$\alpha = \frac{-b + \sqrt{b^2 - 4ac}}{2a} \quad \text{and} \quad \beta = \frac{-b - \sqrt{b^2 - 4ac}}{2a}$$

Also,  $\alpha + \beta = \frac{-b + \sqrt{b^2 - 4ac} - b - \sqrt{b^2 - 4ac}}{2a} = \frac{-b}{a}$

and  $\alpha\beta = \left(\frac{-b + \sqrt{b^2 - 4ac}}{2a}\right) \times \left(\frac{-b - \sqrt{b^2 - 4ac}}{2a}\right) = \frac{c}{a}$ .

Since,  $(x - \alpha)$  and  $(x - \beta)$  are factors of  $ax^2 + bx + c = 0$ ,

We have  $(x - \alpha)(x - \beta) = 0$

Hence,  $x^2 - (\alpha + \beta)x + \alpha\beta = 0$

That is,  $x^2 - (\text{sum of roots})x + \text{product of roots} = 0$  is the general form of the quadratic equation when the roots are given.

#### Note

$ax^2 + bx + c = 0$   
can equivalently  
be expressed as  
 $x^2 + \frac{b}{a}x + \frac{c}{a} = 0$ .  
since  $a \neq 0$

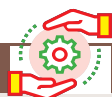

## Activity 2

Consider a rectangular garden in front of a house, whose dimensions are  $(2k + 6)$  metre and  $k$  metre. A smaller rectangular portion of the garden of dimensions  $k$  metre and 3 metres is leveled. Find the area of the garden, not leveled.

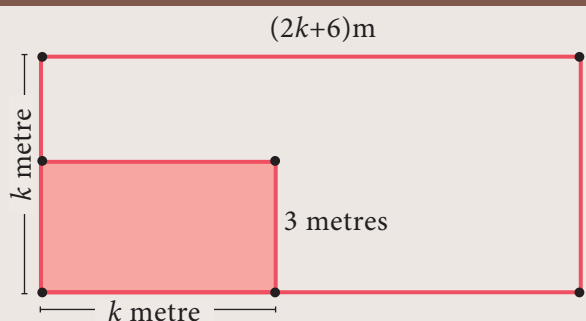

**Example 3.23** Find the zeroes of the quadratic expression  $x^2 + 8x + 12$ .

**Solution** Let  $p(x) = x^2 + 8x + 12 = (x+2)(x+6)$

$$p(-2) = 4 - 16 + 12 = 0$$

$$p(-6) = 36 - 48 + 12 = 0$$

Therefore  $-2$  and  $-6$  are zeros of  $p(x) = x^2 + 8x + 12$

**Example 3.24** Write down the quadratic equation in general form for which sum and product of the roots are given below.

(i) 9, 14      (ii)  $-\frac{7}{2}, \frac{5}{2}$       (iii)  $-\frac{3}{5}, -\frac{1}{2}$

**Solution** (i) General form of the quadratic equation when the roots are given is

$$x^2 - (\text{sum of the roots})x + \text{product of the roots} = 0$$

$$x^2 - 9x + 14 = 0$$

$$(ii) x^2 - \left(-\frac{7}{2}\right)x + \frac{5}{2} = 0 \Rightarrow 2x^2 + 7x + 5 = 0$$

$$(iii) x^2 - \left(-\frac{3}{5}\right)x + \left(-\frac{1}{2}\right) = 0 \Rightarrow \frac{10x^2 + 6x - 5}{10} = 0$$

Therefore,  $10x^2 + 6x - 5 = 0$ .

**Example 3.25** Find the sum and product of the roots for each of the following quadratic equations: (i)  $x^2 + 8x - 65 = 0$       (ii)  $2x^2 + 5x + 7 = 0$

(iii)  $kx^2 - k^2x - 2k^3 = 0$

**Solution** Let  $\alpha$  and  $\beta$  be the roots of the given quadratic equation

(i)  $x^2 + 8x - 65 = 0$

$$a = 1, b = 8, c = -65$$

$$\alpha + \beta = -\frac{b}{a} = -8 \text{ and } \alpha\beta = \frac{c}{a} = -65$$

$$\alpha + \beta = -8; \alpha\beta = -65$$

(ii)  $2x^2 + 5x + 7 = 0$

$$a = 2, \quad b = 5, \quad c = 7$$

$$\alpha + \beta = -\frac{b}{a} = -\frac{5}{2} \quad \text{and} \quad \alpha\beta = \frac{c}{a} = \frac{7}{2}$$

$$\alpha + \beta = -\frac{5}{2}; \quad \alpha\beta = \frac{7}{2}$$

(iii)  $kx^2 - k^2x - 2k^3 = 0$

$$a = k, \quad b = -k^2, \quad c = -2k^3$$

$$\alpha + \beta = -\frac{b}{a} = \frac{-(-k^2)}{k} = k \quad \text{and} \quad \alpha\beta = \frac{c}{a} = \frac{-2k^3}{k} = -2k^2$$

**Exercise 3.9**

1. Determine the quadratic equations, whose sum and product of roots are

(i)  $-9, 20$       (ii)  $\frac{5}{3}, 4$       (iii)  $\frac{-3}{2}, -1$       (iv)  $-(2-a)^2, (a+5)^2$

2. Find the sum and product of the roots for each of the following quadratic equations

(i)  $x^2 + 3x - 28 = 0$       (ii)  $x^2 + 3x = 0$       (iii)  $3 + \frac{1}{a} = \frac{10}{a^2}$       (iv)  $3y^2 - y - 4 = 0$

### 3.6.4 Solving Quadratic Equations

We have already learnt how to solve linear equations in one, two and three variable(s). Recall that the values of the variables which satisfies a given equation are called its **solution(s)**. In this section, we are going to study three methods of solving quadratic equation, namely factorization method, completing the square method and using formula.

#### Solving a quadratic equation by factorization method.

We follow the steps provided below to solve a quadratic equation through factorization method.

**Step 1:** Write the equation in general form  $ax^2 + bx + c = 0$

**Step 2:** By splitting the middle term, factorize the given equation.

**Step 3:** After factorizing, the given quadratic equation can be written as product of two linear factors.

**Step 4:** Equate each linear factor to zero and solve for  $x$ .

These values of  $x$  gives the roots of the equation.

**Example 3.26** Solve  $2x^2 - 2\sqrt{6}x + 3 = 0$

**Solution**  $2x^2 - 2\sqrt{6}x + 3 = 2x^2 - \sqrt{6}x - \sqrt{6}x + 3$  (by splitting the middle term)

$$= \sqrt{2}x(\sqrt{2}x - \sqrt{3}) - \sqrt{3}(\sqrt{2}x - \sqrt{3}) = (\sqrt{2}x - \sqrt{3})(\sqrt{2}x - \sqrt{3})$$

Now, equating the factors to zero we get,

$$(\sqrt{2}x - \sqrt{3})(\sqrt{2}x - \sqrt{3}) = 0$$

$$(\sqrt{2}x - \sqrt{3})^2 = 0$$

$$\sqrt{2}x - \sqrt{3} = 0$$

$$\therefore \text{the solution is } x = \frac{\sqrt{3}}{\sqrt{2}}.$$

**Example 3.27** Solve  $2m^2 + 19m + 30 = 0$

**Solution**  $2m^2 + 19m + 30 = 2m^2 + 4m + 15m + 30 = 2m(m + 2) + 15(m + 2)$

$$= (m + 2)(2m + 15)$$

Equating the factors to zero we get,

$$(m + 2)(2m + 15) = 0$$

$$m + 2 = 0 \Rightarrow m = -2 \text{ or } 2m + 15 = 0 \text{ we get, } m = \frac{-15}{2}$$

Therefore the roots are  $-2, \frac{-15}{2}$ .

Some equations which are not quadratic can be solved by reducing them to quadratic equations by suitable substitutions. Such examples are illustrated below.

**Example 3.28** Solve  $x^4 - 13x^2 + 42 = 0$

**Solution** Let  $x^2 = a$ . Then,  $(x^2)^2 - 13x^2 + 42 = a^2 - 13a + 42 = (a - 7)(a - 6)$

Given,  $(a - 7)(a - 6) = 0$  we get,  $a = 7$  or  $6$ .

Since  $a = x^2$ ,  $x^2 = 7$  then,  $x = \pm\sqrt{7}$  or  $x^2 = 6$  we get,  $x = \pm\sqrt{6}$

Therefore the roots are  $x = \pm\sqrt{7}, \pm\sqrt{6}$

**Example 3.29** Solve  $\frac{x}{x-1} + \frac{x-1}{x} = 2\frac{1}{2}$

**Solution** Let  $y = \frac{x}{x-1}$  then  $\frac{1}{y} = \frac{x-1}{x}$ .

Therefore,  $\frac{x}{x-1} + \frac{x-1}{x} = 2\frac{1}{2}$  becomes  $y + \frac{1}{y} = \frac{5}{2}$

$$2y^2 - 5y + 2 = 0 \text{ then, } y = \frac{1}{2}, 2$$

$$\frac{x}{x-1} = \frac{1}{2} \text{ we get, } 2x = x - 1 \text{ implies } x = -1$$

$$\frac{x}{x-1} = 2 \text{ we get, } x = 2x - 2 \text{ implies } x = 2$$

Therefore, the roots are  $x = -1, 2$ .



### Exercise 3.10

1. Solve the following quadratic equations by factorization method

(i)  $4x^2 - 7x - 2 = 0$       (ii)  $3(p^2 - 6) = p(p + 5)$       (iii)  $\sqrt{a(a-7)} = 3\sqrt{2}$

(iv)  $\sqrt{2}x^2 + 7x + 5\sqrt{2} = 0$       (v)  $2x^2 - x + \frac{1}{8} = 0$

2. The number of volleyball games that must be scheduled in a league with  $n$  teams is given by  $G(n) = \frac{n^2 - n}{2}$  where each team plays with every other team exactly once. A league schedules 15 games. How many teams are in the league?

### Solving a Quadratic Equation by Completing the Square Method

In deriving the formula for the roots of a quadratic equation we used completing the squares method. The same technique can be applied in solving any given quadratic equation through the following steps.

**Step 1:** Write the quadratic equation in general form  $ax^2 + bx + c = 0$ .

**Step 2:** Divide both sides of the equation by the coefficient of  $x^2$  if it is not 1.

**Step 3:** Shift the constant term to the right hand side.

**Step 4:** Add the square of one-half of the coefficient of  $x$  to both sides.

**Step 5:** Write the left hand side as a square and simplify the right hand side.

**Step 6:** Take the square root on both sides and solve for  $x$ .

**Example 3.30** Solve  $x^2 - 3x - 2 = 0$

**Solution**  $x^2 - 3x - 2 = 0$

$$x^2 - 3x = 2 \quad \text{(Shifting the Constant to RHS)}$$

$$x^2 - 3x + \left(\frac{3}{2}\right)^2 = 2 + \left(\frac{3}{2}\right)^2 \quad \text{(Add } \left[\frac{1}{2}(\text{co-efficient of } x)\right]^2 \text{ to both sides)}$$

$$\left(x - \frac{3}{2}\right)^2 = \frac{17}{4} \quad \text{(writing the LHS as complete square)}$$

$$x - \frac{3}{2} = \pm \frac{\sqrt{17}}{2} \quad (\text{Taking the square root on both sides})$$

$$x = \frac{3}{2} + \frac{\sqrt{17}}{2} \quad \text{or} \quad x = \frac{3}{2} - \frac{\sqrt{17}}{2}$$

$$\text{Therefore, } x = \frac{3 + \sqrt{17}}{2}, \frac{3 - \sqrt{17}}{2}$$

**Example 3.31** Solve  $2x^2 - x - 1 = 0$

**Solution**  $2x^2 - x - 1 = 0$

$$x^2 - \frac{x}{2} - \frac{1}{2} = 0 \quad (\div 2 \text{ make co-efficient of } x^2 \text{ as } 1)$$

$$x^2 - \frac{x}{2} = \frac{1}{2}$$

$$x^2 - \frac{x}{2} + \left(\frac{1}{4}\right)^2 = \frac{1}{2} + \left(\frac{1}{4}\right)^2$$

$$\left(x - \frac{1}{4}\right)^2 = \frac{9}{16} = \left(\frac{3}{4}\right)^2$$

$$x - \frac{1}{4} = \pm \frac{3}{4} \Rightarrow x = 1, -\frac{1}{2}$$

### Solving a Quadratic Equation by Formula Method

The formula for finding roots of a quadratic equation  $ax^2 + bx + c = 0$  (derivation given in section 3.6.2) is  $x = \frac{-b \pm \sqrt{b^2 - 4ac}}{2a}$ .



The formula for finding roots of a quadratic equation was known to Ancient Babylonians, though not in a form as we derived. They found the roots by creating the steps as a verse, which is a common practice at their times. Babylonians used quadratic equations for deciding to choose the dimensions of their land for agriculture.

**Example 3.32** Solve  $x^2 + 2x - 2 = 0$  by formula method

**Solution** Compare  $x^2 + 2x - 2 = 0$  with the standard form  $ax^2 + bx + c = 0$

$$a = 1, b = 2, c = -2$$

$$x = \frac{-b \pm \sqrt{b^2 - 4ac}}{2a}$$

substituting the values of  $a$ ,  $b$  and  $c$  in the formula we get,

$$x = \frac{-2 \pm \sqrt{(2)^2 - 4(1)(-2)}}{2(1)} = \frac{-2 \pm \sqrt{12}}{2} = -1 \pm \sqrt{3}$$

Therefore,  $x = -1 + \sqrt{3}, -1 - \sqrt{3}$

**Example 3.33** Solve  $2x^2 - 3x - 3 = 0$  by formula method.

**Solution** Compare  $2x^2 - 3x - 3 = 0$  with the standard form  $ax^2 + bx + c = 0$

$$a = 2, b = -3, c = -3$$

$$x = \frac{-b \pm \sqrt{b^2 - 4ac}}{2a}$$

substituting the values of  $a$ ,  $b$  and  $c$  in the formula we get,

$$x = \frac{-(-3) \pm \sqrt{(-3)^2 - 4(2)(-3)}}{2(2)} = \frac{3 \pm \sqrt{33}}{4}$$

$$\text{Therefore, } x = \frac{3 + \sqrt{33}}{4}, \frac{3 - \sqrt{33}}{4}$$

**Example 3.34** Solve  $3p^2 + 2\sqrt{5}p - 5 = 0$  by formula method.

**Solution** Compare  $3p^2 + 2\sqrt{5}p - 5 = 0$  with the Standard form  $ax^2 + bx + c = 0$

$$a = 3, b = 2\sqrt{5}, c = -5.$$

$$p = \frac{-b \pm \sqrt{b^2 - 4ac}}{2a}$$

substituting the values of  $a$ ,  $b$  and  $c$  in the formula we get,

$$p = \frac{-2\sqrt{5} \pm \sqrt{(2\sqrt{5})^2 - 4(3)(-5)}}{2(3)} = \frac{-2\sqrt{5} \pm \sqrt{80}}{6} = \frac{-\sqrt{5} \pm 2\sqrt{5}}{3}$$

$$\text{Therefore, } x = \frac{\sqrt{5}}{3}, -\sqrt{5}$$

**Example 3.35** Solve  $pqx^2 - (p+q)^2x + (p+q)^2 = 0$

**Solution** Compare the coefficients of the given equation with the standard form  $ax^2 + bx + c = 0$

$$a = pq, b = -(p+q)^2, c = (p+q)^2$$

$$x = \frac{-b \pm \sqrt{b^2 - 4ac}}{2a}$$

substituting the values of  $a$ ,  $b$  and  $c$  in the formula we get,

$$\begin{aligned} x &= \frac{-[-(p+q)^2] \pm \sqrt{[-(p+q)^2]^2 - 4(pq)(p+q)^2}}{2pq} \\ &= \frac{(p+q)^2 \pm \sqrt{(p+q)^4 - 4(pq)(p+q)^2}}{2pq} \end{aligned}$$

$$\begin{aligned}
 &= \frac{(p+q)^2 \pm \sqrt{(p+q)^2[(p+q)^2 - 4pq]}}{2pq} \\
 &= \frac{(p+q)^2 \pm \sqrt{(p+q)^2(p^2 + q^2 + 2pq - 4pq)}}{2pq} \\
 &= \frac{(p+q)^2 \pm \sqrt{(p+q)^2(p-q)^2}}{2pq} \\
 &= \frac{(p+q)^2 \pm (p+q)(p-q)}{2pq} = \frac{(p+q)\{(p+q) \pm (p-q)\}}{2pq}
 \end{aligned}$$

Therefore,  $x = \frac{p+q}{2pq} \times 2p$ ,  $\frac{p+q}{2pq} \times 2q$  we get,  $x = \frac{p+q}{q}$ ,  $\frac{p+q}{p}$

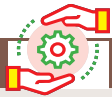

### Activity 3

Serve the fishes (Equations) with its appropriate food (roots). Identify a fish which cannot be served?

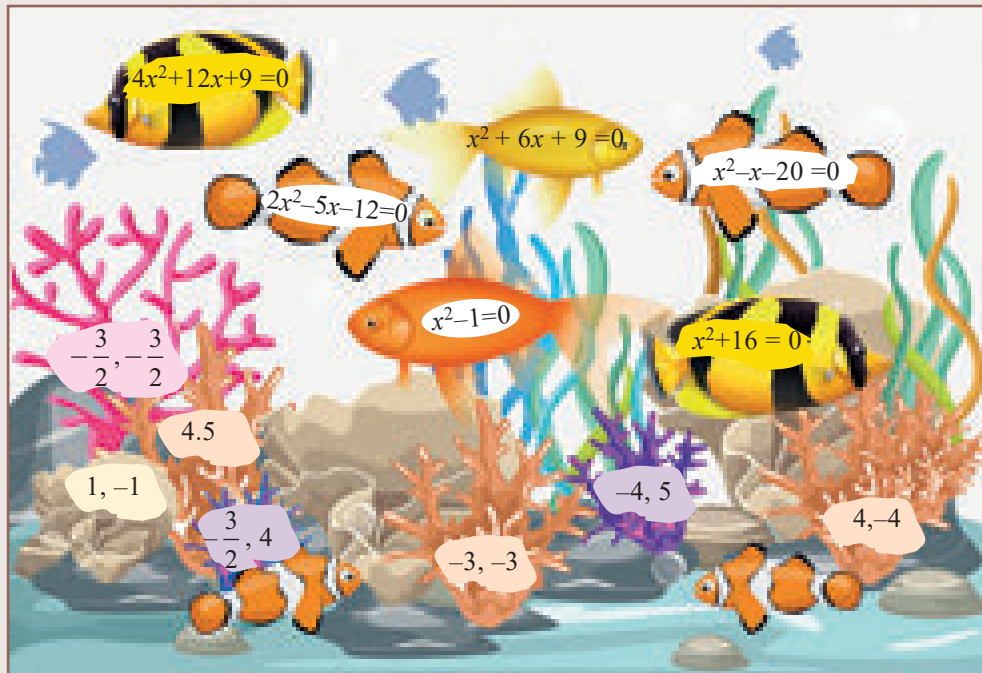

### Exercise 3.11

1. Solve the following quadratic equations by completing the square method

(i)  $9x^2 - 12x + 4 = 0$       (ii)  $\frac{5x+7}{x-1} = 3x+2$

2. Solve the following quadratic equations by formula method

(i)  $2x^2 - 5x + 2 = 0$       (ii)  $\sqrt{2}f^2 - 6f + 3\sqrt{2} = 0$       (iii)  $3y^2 - 20y - 23 = 0$   
 (iv)  $36y^2 - 12ay + (a^2 - b^2) = 0$

3. A ball rolls down a slope and travels a distance  $d = t^2 - 0.75t$  feet in  $t$  seconds. Find the time when the distance travelled by the ball is 11.25 feet.





### 3.6.5 Solving Problems Involving Quadratic Equations

#### Steps to solve a problem

**Step 1:** Convert the word problem to a quadratic equation form

**Step 2:** Solve the quadratic equation obtained in any one of the above three methods.

**Step 3:** Relate the mathematical solution obtained to the statement asked in the question.

**Example 3.36** The product of Kumaran's age (in years) two years ago and his age four years from now is one more than twice his present age. What is his present age?

**Solution** Let the present age of Kumaran be  $x$  years.

Two years ago, his age =  $(x - 2)$  years.

Four years from now, his age =  $(x + 4)$  years.

Given,  $(x - 2)(x + 4) = 1 + 2x$

$$x^2 + 2x - 8 = 1 + 2x \Rightarrow (x - 3)(x + 3) = 0 \text{ then, } x = \pm 3$$

Therefore,  $x = 3$  (Rejecting  $-3$  as age cannot be negative)

Kumaran's present age is 3 years.

**Example 3.37** A ladder 17 feet long is leaning against a wall. If the ladder, vertical wall and the floor from the bottom of the wall to the ladder form a right triangle, find the height of the wall where the top of the ladder meets if the distance between bottom of the wall to bottom of the ladder is 7 feet less than the height of the wall?

**Solution** Let the height of the wall  $AB = x$  feet

As per the given data  $BC = (x - 7)$  feet

In the right triangle  $ABC$ ,  $AC = 17$  ft,  $BC = (x - 7)$  feet

By Pythagoras theorem,  $AC^2 = AB^2 + BC^2$

$$(17)^2 = x^2 + (x - 7)^2; 289 = x^2 + x^2 - 14x + 49$$

$$x^2 - 7x - 120 = 0 \text{ hence, } (x - 15)(x + 8) = 0 \text{ then, } x = 15 \text{ (or) } -8$$

Therefore, height of the wall  $AB = 15$  ft (Rejecting  $-8$  as height cannot be negative)

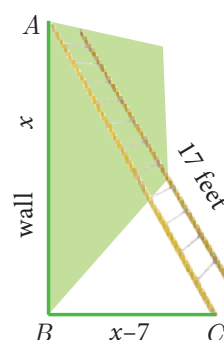

Fig. 3.7

**Example 3.38** A flock of swans contained  $x^2$  members. As the clouds gathered,  $10x$  went to a lake and one-eighth of the members flew away to a garden. The remaining three pairs played about in the water. How many swans were there in total?

**Solution** As given there are  $x^2$  swans.

As per the given data  $x^2 - 10x - \frac{1}{8}x^2 = 6$  we get,  $7x^2 - 80x - 48 = 0$

$$x = \frac{-b \pm \sqrt{b^2 - 4ac}}{2a} = \frac{80 \pm \sqrt{6400 - 4(7)(-48)}}{14} = \frac{80 \pm 88}{14}$$

Therefore,  $x = 12, -\frac{4}{7}$ .

Here  $x = -\frac{4}{7}$  is not possible as the number of swans cannot be negative.

Hence,  $x = 12$ . Therefore total number of swans is  $x^2 = 144$ .

**Example 3.39** A passenger train takes 1 hr more than an express train to travel a distance of 240 km from Chennai to Virudhachalam. The speed of passenger train is less than that of an express train by 20 km per hour. Find the average speed of both the trains.

**Solution** Let the average speed of passenger train be  $x$  km/hr.

Then the average speed of express train will be  $(x + 20)$  km/hr

Time taken by the passenger train to cover distance of 240 km =  $\frac{240}{x}$  hr

Time taken by express train to cover distance of 240 km =  $\frac{240}{x + 20}$  hr

Given,  $\frac{240}{x} = \frac{240}{x + 20} + 1$

$$240 \left[ \frac{1}{x} - \frac{1}{x + 20} \right] = 1 \Rightarrow 240 \left[ \frac{x + 20 - x}{x(x + 20)} \right] = 1 \text{ we get, } 4800 = (x^2 + 20x)$$

$$x^2 + 20x - 4800 = 0 \Rightarrow (x + 80)(x - 60) = 0 \text{ we get, } x = -80 \text{ or } 60.$$

Therefore  $x = 60$  (Rejecting  $-80$  as speed cannot be negative)

Average speed of the passenger train is 60 km/hr

Average speed of the express train is 80 km/hr.



### Exercise 3.12

1. If the difference between a number and its reciprocal is  $\frac{24}{5}$ , find the number.
2. A garden measuring 12m by 16m is to have a pedestrian pathway that is 'w' meters wide installed all the way around so that it increases the total area to 285 m<sup>2</sup>. What is the width of the pathway?
3. A bus covers a distance of 90 km at a uniform speed. Had the speed been 15 km/hour more it would have taken 30 minutes less for the journey. Find the original speed of the bus.
4. A girl is twice as old as her sister. Five years hence, the product of their ages (in years) will be 375. Find their present ages.
5. A pole has to be erected at a point on the boundary of a circular ground of diameter 20 m in such a way that the difference of its distances from two diametrically opposite fixed gates P and Q on the boundary is 4 m. Is it possible to do so? If answer is yes at what distance from the two gates should the pole be erected?
6. From a group of  $2x^2$  black bees, square root of half of the group went to a tree. Again eight-ninth of the bees went to the same tree. The remaining two got caught up in a fragrant lotus. How many bees were there in total?

7. Music is been played in two opposite galleries with certain group of people. In the first gallery a group of 4 singers were singing and in the second gallery 9 singers were singing. The two galleries are separated by the distance of 70 m. Where should a person stand for hearing the same intensity of the singers voice? (Hint: The ratio of the sound intensity is equal to the square of the ratio of their corresponding distances).
8. There is a square field whose side is 10 m. A square flower bed is prepared in its centre leaving a gravel path all round the flower bed. The total cost of laying the flower bed and gravelling the path at ₹3 and ₹4 per square metre respectively is ₹364. Find the width of the gravel path.
9. The hypotenuse of a right angled triangle is 25 cm and its perimeter 56 cm. Find the length of the smallest side.

### 3.6.6 Nature of Roots of a Quadratic Equation

The roots of the quadratic equation  $ax^2 + bx + c = 0$ ,  $a \neq 0$  are found using the formula  $x = \frac{-b \pm \sqrt{b^2 - 4ac}}{2a}$ . Here,  $b^2 - 4ac$  called as the **discriminant** (which is denoted by  $\Delta$ ) of the quadratic equation, decides the nature of roots as follows

Values of Discriminant $\Delta = b^2 - 4ac$	Nature of Roots
$\Delta > 0$	Real and Unequal roots
$\Delta = 0$	Real and Equal roots
$\Delta < 0$	No Real root

**Example 3.40** Determine the nature of roots for the following quadratic equations

(i)  $x^2 - x - 20 = 0$     (ii)  $9x^2 - 24x + 16 = 0$     (iii)  $2x^2 - 2x + 9 = 0$

**Solution** (i)  $x^2 - x - 20 = 0$

Here,  $a = 1$ ,  $b = -1$ ,  $c = -20$

Now,  $\Delta = b^2 - 4ac$

$$\Delta = (-1)^2 - 4(1)(-20) = 81$$

Here,  $\Delta = 81 > 0$ . So, the equation will have real and unequal roots

(ii)  $9x^2 - 24x + 16 = 0$

Here,  $a = 9$ ,  $b = -24$ ,  $c = 16$

Now,  $\Delta = b^2 - 4ac = (-24)^2 - 4(9)(16) = 0$

Here,  $\Delta = 0$ . So, the equation will have real and equal roots.

$$(iii) \quad 2x^2 - 2x + 9 = 0$$

$$\text{Here, } a = 2, b = -2, c = 9$$

$$\text{Now, } \Delta = b^2 - 4ac = (-2)^2 - 4(2)(9) = -68$$

Here,  $\Delta = -68 < 0$ . So, the equation will have no real roots.

**Example 3.41** (i) Find the values of 'k', for which the quadratic equation  $kx^2 - (8k + 4)x + 81 = 0$  has real and equal roots?

(ii) Find the values of 'k' such that quadratic equation  $(k + 9)x^2 + (k + 1)x + 1 = 0$  has no real roots?

**Solution** (i)  $kx^2 - (8k + 4)x + 81 = 0$

Since the equation has real and equal roots,  $\Delta = 0$ .

$$\text{That is, } b^2 - 4ac = 0$$

$$\text{Here, } a = k, b = -(8k + 4), c = 81$$

$$\text{That is, } [-(8k + 4)]^2 - 4(k)(81) = 0$$

$$64k^2 + 64k + 16 - 324k = 0$$

$$64k^2 - 260k + 16 = 0$$

Dividing by 4 we get  $16k^2 - 65k + 4 = 0$

$$(16k - 1)(k - 4) = 0 \text{ then, } k = \frac{1}{16} \text{ or } k = 4$$

(ii)  $(k + 9)x^2 + (k + 1)x + 1 = 0$

Since the equation has no real roots,  $\Delta < 0$

$$\text{That is, } b^2 - 4ac < 0$$

$$\text{Here, } a = k + 9, b = k + 1, c = 1$$

$$\text{That is, } (k + 1)^2 - 4(k + 9)(1) < 0$$

$$k^2 + 2k + 1 - 4k - 36 < 0$$

$$k^2 - 2k - 35 < 0$$

$$(k + 5)(k - 7) < 0$$

Therefore,  $-5 < k < 7$ . {If  $\alpha < \beta$  and if  $(x - \alpha)(x - \beta) < 0$  then,  $\alpha < x < \beta$ }.

**Example 3.42** Prove that the equation  $x^2(p^2 + q^2) + 2x(pr + qs) + r^2 + s^2 = 0$  has no real roots. If  $ps = qr$ , then show that the roots are real and equal.

**Solution** The given quadratic equation is,  $x^2(p^2 + q^2) + 2x(pr + qs) + r^2 + s^2 = 0$

Here,  $a = p^2 + q^2$ ,  $b = 2(pr + qs)$ ,  $c = r^2 + s^2$

$$\begin{aligned} \text{Now, } \Delta = b^2 - 4ac &= [2(pr + qs)]^2 - 4(p^2 + q^2)(r^2 + s^2) \\ &= 4[p^2r^2 + 2pqrs + q^2s^2 - p^2r^2 - p^2s^2 - q^2r^2 - q^2s^2] \\ &= 4[-p^2s^2 + 2pqrs - q^2r^2] = -4[(ps - qr)^2] < 0 \quad \dots(1) \end{aligned}$$

since,  $\Delta = b^2 - 4ac < 0$ , the roots are not real.

If  $ps = qr$  then  $\Delta = -4[ps - qr]^2 = -4[qr - qr]^2 = 0$  (using (1))

Thus,  $\Delta = 0$  if  $ps = qr$  and so the roots will be real and equal.



### Exercise 3.13

- Determine the nature of the roots for the following quadratic equations
  - $15x^2 + 11x + 2 = 0$
  - $x^2 - x - 1 = 0$
  - $\sqrt{2}t^2 - 3t + 3\sqrt{2} = 0$
  - $9y^2 - 6\sqrt{2}y + 2 = 0$
  - $9a^2b^2x^2 - 24abcdx + 16c^2d^2 = 0$ ,  $a \neq 0$ ,  $b \neq 0$
- Find the value(s) of 'k' for which the roots of the following equations are real and equal.
  - $(5k - 6)x^2 + 2kx + 1 = 0$
  - $kx^2 + (6k + 2)x + 16 = 0$
- If the roots of  $(a - b)x^2 + (b - c)x + (c - a) = 0$  are real and equal, then prove that  $b$ ,  $a$ ,  $c$  are in arithmetic progression.
- If  $a$ ,  $b$  are real then show that the roots of the equation  $(a - b)x^2 - 6(a + b)x - 9(a - b) = 0$  are real and unequal.
- If the roots of the equation  $(c^2 - ab)x^2 - 2(a^2 - bc)x + b^2 - ac = 0$  are real and equal prove that either  $a=0$  (or)  $a^3 + b^3 + c^3 = 3abc$

### Thinking Corner

Fill in the empty box in each of the given expression so that the resulting quadratic polynomial becomes a perfect square.

(i)  $x^2 + 14x + \square$       (ii)  $x^2 - 24x + \square$       (iii)  $p^2 + 2qp + \square$

### 3.6.7 The Relation between Roots and Coefficients of a Quadratic Equation

Let  $\alpha$  and  $\beta$  are the roots of the equation  $ax^2 + bx + c = 0$  then,

$$\alpha = \frac{-b + \sqrt{b^2 - 4ac}}{2a}, \quad \beta = \frac{-b - \sqrt{b^2 - 4ac}}{2a}$$

From 3.6.3, we get

$$\alpha + \beta = \frac{-b}{a} = \frac{\text{Co-efficient of } x}{\text{Co-efficient of } x^2}$$

$$\alpha\beta = \frac{c}{a} = \frac{\text{Constant term}}{\text{Co-efficient of } x^2}$$



## Progress Check

Quadratic equation	Roots of quadratic equation $\alpha$ and $\beta$	co-efficients of $x^2$ , $x$ and constants	Sum of Roots $\alpha + \beta$	Product of roots $\alpha\beta$	$-\frac{b}{a}$	$\frac{c}{a}$	Conclusion
$4x^2 - 9x + 2 = 0$							
$\left(x - \frac{4}{5}\right)^2 = 0$							
$2x^2 - 15x - 27 = 0$							

**Example 3.43** If the difference between the roots of the equation  $x^2 - 13x + k = 0$  is 17 find  $k$ .

**Solution**  $x^2 - 13x + k = 0$  here,  $a = 1$ ,  $b = -13$ ,  $c = k$

Let  $\alpha, \beta$  be the roots of the equation. Then

$$\alpha + \beta = \frac{-b}{a} = \frac{-(-13)}{1} = 13 \dots(1) \text{ Also } \alpha - \beta = 17 \dots(2)$$

$$(1)+(2) \text{ we get, } 2\alpha = 30 \Rightarrow \alpha = 15$$

Therefore,  $15 + \beta = 13$  (from (1))  $\Rightarrow \beta = -2$

$$\text{But, } \alpha\beta = \frac{c}{a} = \frac{k}{1} \Rightarrow 15 \times (-2) = k \text{ we get, } k = -30$$

**Example 3.44** If  $\alpha$  and  $\beta$  are the roots of  $x^2 + 7x + 10 = 0$  find the values of

(i)  $(\alpha - \beta)$  (ii)  $\alpha^2 + \beta^2$  (iii)  $\alpha^3 - \beta^3$  (iv)  $\alpha^4 + \beta^4$  (v)  $\frac{\alpha}{\beta} + \frac{\beta}{\alpha}$  (vi)  $\frac{\alpha^2}{\beta} + \frac{\beta^2}{\alpha}$

**Solution**  $x^2 + 7x + 10 = 0$  here,  $a = 1$ ,  $b = 7$ ,  $c = 10$

If  $\alpha$  and  $\beta$  are roots of the equation then,

$$\alpha + \beta = \frac{-b}{a} = \frac{-7}{1} = -7; \alpha\beta = \frac{c}{a} = \frac{10}{1} = 10$$

$$(i) \quad \alpha - \beta = \sqrt{(\alpha + \beta)^2 - 4\alpha\beta} = \sqrt{(-7)^2 - 4 \times 10} = \sqrt{9} = 3$$

$$(ii) \quad \alpha^2 + \beta^2 = (\alpha + \beta)^2 - 2\alpha\beta = (-7)^2 - 2 \times 10 = 29$$

$$(iii) \quad \alpha^3 - \beta^3 = (\alpha - \beta)^3 + 3\alpha\beta(\alpha - \beta) = (3)^3 + 3(10)(3) = 117$$

$$(iv) \quad \alpha^4 + \beta^4 = (\alpha^2 + \beta^2)^2 - 2\alpha^2\beta^2 = 29^2 - 2 \times (10)^2 = 641 \text{ (from (ii), } \alpha^2 + \beta^2 = 29)$$

$$(v) \quad \frac{\alpha}{\beta} + \frac{\beta}{\alpha} = \frac{\alpha^2 + \beta^2}{\alpha\beta} = \frac{(\alpha + \beta)^2 - 2\alpha\beta}{\alpha\beta} = \frac{49 - 20}{10} = \frac{29}{10}$$

## Thinking Corner

If the constant term of  $ax^2 + bx + c = 0$  is zero, then the sum and product of roots are \_\_\_\_\_ and \_\_\_\_\_.

$$\begin{aligned}
 \text{(vi)} \quad \frac{\alpha^2}{\beta} + \frac{\beta^2}{\alpha} &= \frac{\alpha^3 + \beta^3}{\alpha\beta} = \frac{(\alpha + \beta)^3 - 3\alpha\beta(\alpha + \beta)}{\alpha\beta} \\
 &= \frac{(-343) - 3(10 \times (-7))}{10} = \frac{-343 + 210}{10} = \frac{-133}{10}
 \end{aligned}$$

**Example 3.45** If  $\alpha, \beta$  are the roots of the equation  $3x^2 + 7x - 2 = 0$ , find the values of

$$\text{(i)} \quad \frac{\alpha}{\beta} + \frac{\beta}{\alpha} \quad \text{(ii)} \quad \frac{\alpha^2}{\beta} + \frac{\beta^2}{\alpha}$$

**Solution**  $3x^2 + 7x - 2 = 0$  here,  $a = 3, b = 7, c = -2$

since,  $\alpha, \beta$  are the roots of the equation

$$\text{(i)} \quad \alpha + \beta = \frac{-b}{a} = \frac{-7}{3}; \quad \alpha\beta = \frac{c}{a} = \frac{-2}{3}$$

$$\frac{\alpha}{\beta} + \frac{\beta}{\alpha} = \frac{\alpha^2 + \beta^2}{\alpha\beta} = \frac{(\alpha + \beta)^2 - 2\alpha\beta}{\alpha\beta} = \frac{\left(\frac{-7}{3}\right)^2 - 2\left(\frac{-2}{3}\right)}{\frac{-2}{3}} = \frac{-61}{6}$$

$$\text{(ii)} \quad \frac{\alpha^2}{\beta} + \frac{\beta^2}{\alpha} = \frac{\alpha^3 + \beta^3}{\alpha\beta} = \frac{(\alpha + \beta)^3 - 3\alpha\beta(\alpha + \beta)}{\alpha\beta} = \frac{\left(\frac{-7}{3}\right)^3 - 3\left(\frac{-2}{3}\right)\left(\frac{-7}{3}\right)}{\frac{-2}{3}} = \frac{469}{18}$$

**Example 3.46** If  $\alpha, \beta$  are the roots of the equation  $2x^2 - x - 1 = 0$ , then form the equation whose roots are (i)  $\frac{1}{\alpha}, \frac{1}{\beta}$  (ii)  $\alpha^2\beta, \beta^2\alpha$  (iii)  $2\alpha + \beta, 2\beta + \alpha$

**Solution**  $2x^2 - x - 1 = 0$  here,  $a = 2, b = -1, c = -1$

$$\alpha + \beta = \frac{-b}{a} = \frac{-(-1)}{2} = \frac{1}{2}; \quad \alpha\beta = \frac{c}{a} = -\frac{1}{2}$$

$$\text{(i)} \quad \text{Given roots are } \frac{1}{\alpha}, \frac{1}{\beta}$$

$$\text{Sum of the roots} = \frac{1}{\alpha} + \frac{1}{\beta} = \frac{\alpha + \beta}{\alpha\beta} = \frac{\frac{1}{2}}{-\frac{1}{2}} = -1$$

$$\text{Product of the roots} = \frac{1}{\alpha} \times \frac{1}{\beta} = \frac{1}{\alpha\beta} = \frac{1}{-\frac{1}{2}} = -2$$

The required equation is  $x^2 - (\text{Sum of the roots})x + (\text{Product of the roots}) = 0$

$$x^2 - (-1)x - 2 = 0 \Rightarrow x^2 + x - 2 = 0$$

$$\text{(ii)} \quad \text{Given roots are } \alpha^2\beta, \beta^2\alpha$$

$$\text{Sum of the roots } \alpha^2\beta + \beta^2\alpha = \alpha\beta(\alpha + \beta) = -\frac{1}{2} \left(\frac{1}{2}\right) = -\frac{1}{4}$$

Product of the roots  $(\alpha^2\beta) \times (\beta^2\alpha) = \alpha^3\beta^3 = (\alpha\beta)^3 = \left(-\frac{1}{2}\right)^3 = -\frac{1}{8}$

The required equation is  $x^2 - (\text{Sum of the roots})x + (\text{Product of the roots})=0$

$$x^2 - \left(-\frac{1}{4}\right)x - \frac{1}{8} = 0 \Rightarrow 8x^2 + 2x - 1 = 0$$

(iii)  $2\alpha + \beta, 2\beta + \alpha$

Sum of the roots  $2\alpha + \beta + 2\beta + \alpha = 3(\alpha + \beta) = 3\left(\frac{1}{2}\right) = \frac{3}{2}$

Product of the roots  $= (2\alpha + \beta)(2\beta + \alpha) = 4\alpha\beta + 2\alpha^2 + 2\beta^2 + \alpha\beta$   
 $= 5\alpha\beta + 2(\alpha^2 + \beta^2) = 5\alpha\beta + 2\left[(\alpha + \beta)^2 - 2\alpha\beta\right]$   
 $= 5\left(-\frac{1}{2}\right) + 2\left[\frac{1}{4} - 2 \times -\frac{1}{2}\right] = 0$

The required equation is  $x^2 - (\text{Sum of the roots})x + (\text{Product of the roots})=0$

$$x^2 - \frac{3}{2}x + 0 = 0 \Rightarrow 2x^2 - 3x = 0$$



### Exercise 3.14

- Write each of the following expression in terms of  $\alpha + \beta$  and  $\alpha\beta$ .
  - $\frac{\alpha}{3\beta} + \frac{\beta}{3\alpha}$
  - $\frac{1}{\alpha^2\beta} + \frac{1}{\beta^2\alpha}$
  - $(3\alpha - 1)(3\beta - 1)$
  - $\frac{\alpha + 3}{\beta} + \frac{\beta + 3}{\alpha}$
- The roots of the equation  $2x^2 - 7x + 5 = 0$  are  $\alpha$  and  $\beta$ . Without solving for the roots, find
  - $\frac{1}{\alpha} + \frac{1}{\beta}$
  - $\frac{\alpha}{\beta} + \frac{\beta}{\alpha}$
  - $\frac{\alpha + 2}{\beta + 2} + \frac{\beta + 2}{\alpha + 2}$
- The roots of the equation  $x^2 + 6x - 4 = 0$  are  $\alpha, \beta$ . Find the quadratic equation whose roots are
  - $\alpha^2$  and  $\beta^2$
  - $\frac{2}{\alpha}$  and  $\frac{2}{\beta}$
  - $\alpha^2\beta$  and  $\beta^2\alpha$
- If  $\alpha, \beta$  are the roots of  $7x^2 + ax + 2 = 0$  and if  $\beta - \alpha = \frac{-13}{7}$ . Find the values of  $a$ .
- If one root of the equation  $2y^2 - ay + 64 = 0$  is twice the other then find the values of  $a$ .
- If one root of the equation  $3x^2 + kx + 81 = 0$  (having real roots) is the square of the other then find  $k$ .





### 3.7 Graph of Variations

#### Variables:

Every day, Harini travels from her home, cycling at a uniform speed, to reach her school. You can state this mathematically by an equation  $d = rt$ , where  $d$  stands for distance travelled at any time  $t$  and  $r$  is the uniform rate of speed.



Suppose you want to find the distance covered by her at a speed of 20 km per hour when she has cycled for fifteen minutes.

$$r = 20 \text{ and } t = \frac{1}{4} \text{ (how?) and we find } d \text{ to be } rt = 20 \times \frac{1}{4} = 5 \text{ km.}$$

Here, we say that  $d$  is a dependent variable and  $r$  and  $t$  are independent variables. As the distance  $d$  travelled depends upon the rate  $r$  and time used  $t$ .

Thus, an **independent variable** represents a quantity that is manipulated in a given situation where as a **dependent variable** represents a quantity whose value depends on how the independent variable is manipulated.

Equations that describe the relationship between two variables in a sentence express the variation between those variables.

Consider the monthly income of Server Suresh who works in a hotel where he is paid ₹ 50 per hour.



There are two variables here. One is the monthly income and the other is the number of hours he works. Which among the two is the independent variable?

#### Constants:

You know how to calculate the area of a circle when the length of its radius is given. If the area required is  $A$  and the length of radius is  $r$ , then the formula

$$A = \pi r^2$$

gives the required result. Here, the area  $A$  depends upon the length  $r$  of radius; thus  $A$  is a dependent variable and  $r$  is the independent variable. But what can we say about  $\pi$ ? It is a number that remains the same in all the situations. It is constant.

A constant is a quantity that assumes a fixed value throughout in a specific mathematical context.

#### Two types of variation:

When two things are in proportion, there is a relation between them, due to which, if the value of one of them changes, the value of the other also changes. We look into two types of variations here:

- (i) Direct variation
- (ii) Indirect variation.

#### (i) Direct variation:

When you go to the market, to buy more apples, you'll have to spend more amount of **money**. If the cost of one kg of apples is ₹ 200, you pay as follows:

<b>Weight (Kg)</b>	1	2	3	4	5
<b>Cost (₹)</b>	200	400	600	800	1000

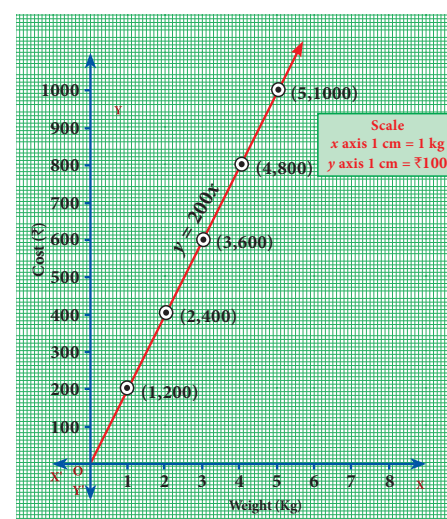

Fig. 3.8

You find that  $\frac{1}{200} = \frac{2}{400} = \frac{3}{600} = \frac{4}{800} = \frac{5}{1000} = \dots$

This kind of proportionate variation is known as **Direct variation**. Here to find the cost, the weight is multiplied by the constant 200.

If we denote the variable weight as  $x$  and the variable cost as  $y$  we can express this algebraically as  $y = 200x$ . The multiplying constant here is 200.

If  $\frac{y}{x} = k$  where  $k$  is a positive **number** (a constant), then  $x$  and  $y$  are said to vary directly. Here,  $k$  is known as the constant of proportionality.



**Mathematics in real life:** This figure shows that doubling the force doubles the displacement. This is a consequence of what is known as *Hooke's law*. It states  $F = kx$  where  $F$  is the force needed to produce a displacement of  $x$  in the position of a spring. To double the displacement, you double the force on the spring; the constant of proportionality  $k$  depends on the stiffness of the spring. So this is an example of a direct proportionality.

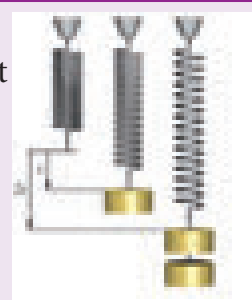

**Visualising Direct variation:**

To identify direct variation is to look at the equation and determine if it is of the form  $y = kx$ , where  $k$  is the constant of proportionality. Thus, an equation like  $y = 5x$  will always indicate direct proportion among variables.

**Thinking Corner**

What can you say if the variables  $x$  and  $y$  are related by the equation  $3y - 7x = 0$ ? It also indicates direct variation. How? Think about it. In that case, what is the constant of proportionality?

**Observe this graph:**

The distance travelled and the time taken are proportional, but how do we know that?

Note that

- i) The graph is a straight line.
- ii) The line passes through the origin. When both of these features are present we know that the two quantities on the graph must be directly proportional.

Do you see this in the graph?

<b>Time (in minutes)</b>	4	8	12	16
<b>Distance (in km)</b>	8	16	24	32

If one variable doubles, the other also doubles. From this you can see the relation  $d = rt$  and it is easy to guess the constant of proportionality.

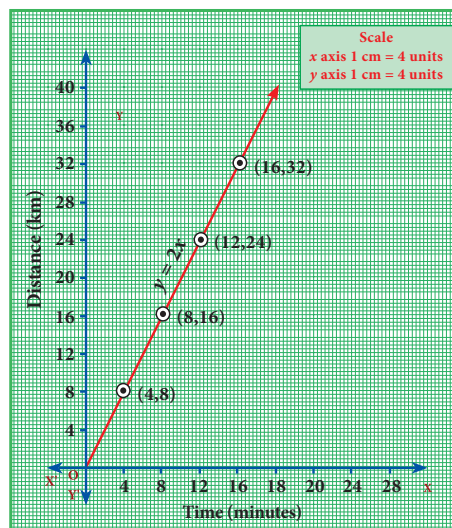

Fig. 3.9

**Example 3.47** Varshika drew 6 circles with different sizes. Draw a graph for the relationship between the diameter and circumference (approximately related) of each circle as shown in the table and use it to find the circumference of a circle when its diameter is 6 cm.

<b>Diameter (x) cm</b>	1	2	3	4	5
<b>Circumference (y) cm</b>	3.1	6.2	9.3	12.4	15.5

**Solution:**

From the table, we found that as  $x$  increases,  $y$  also increases. Thus, the variation is a **direct variation**.

Let  $y = kx$ , where  $k$  is a constant of proportionality.

From the given values, we have,

$$k = \frac{3.1}{1} = \frac{6.2}{2} = \frac{9.3}{3} = \frac{12.4}{4} = \dots = 3.1$$

When you plot the points (1, 3.1) (2, 6.2) (3, 9.3), (4, 12.4), (5, 15.5), you find the relation  $y = (3.1)x$  forms a straight-line graph.

Clearly, from the graph, when diameter is 6 cm, its circumference is 18.6 cm.

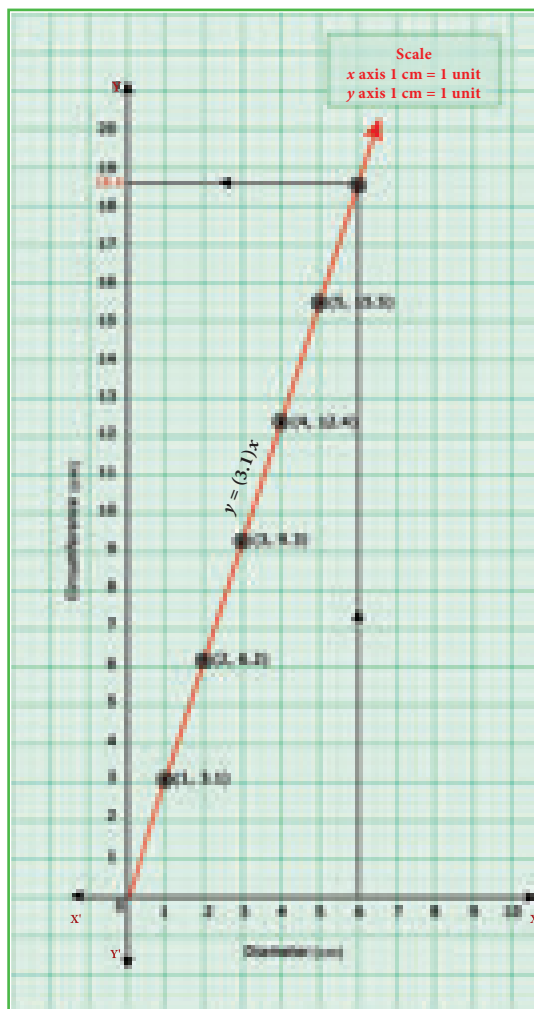

Fig. 3.10

**Example 3.48** A bus is travelling at a uniform speed of 50 km/hr. Draw the distance-time graph and hence find

- (i) the constant of variation
- (ii) how far will it travel in  $1\frac{1}{2}$  hr
- (iii) the time required to cover a distance of 300 km from the graph.

**Solution**

Let  $x$  be the time taken in minutes and  $y$  be the distance travelled in km.

<b>Time taken x (in minutes)</b>	60	120	180	240
<b>Distance y (in km)</b>	50	100	150	200

- (i) Observe that as time increases, the distance travelled also increases. Therefore, the variation is a direct variation. It is of the form  $y = kx$ .

Constant of variation

$$k = \frac{y}{x} = \frac{50}{60} = \frac{100}{120} = \frac{150}{180} = \frac{200}{240} = \frac{5}{6}$$



Hence, the relation may be given as

$$y = kx \Rightarrow y = \frac{5}{6}x$$

(ii) From the graph,  $y = \frac{5x}{6}$ , if  $x = 90$ , then  $y = \frac{5}{6} \times 90 = 75$  km

The distance travelled for  $1\frac{1}{2}$  hours (i.e.,) 90 minutes is 75 km.

(iii) From the graph,  $y = \frac{5x}{6}$ , if  $y = 300$  then  $x = \frac{6y}{5} = \frac{6}{5} \times 300 = 360$  minutes (or) 6 hours.

The time taken to cover 300 km is 360 minutes, that is 6 hours.

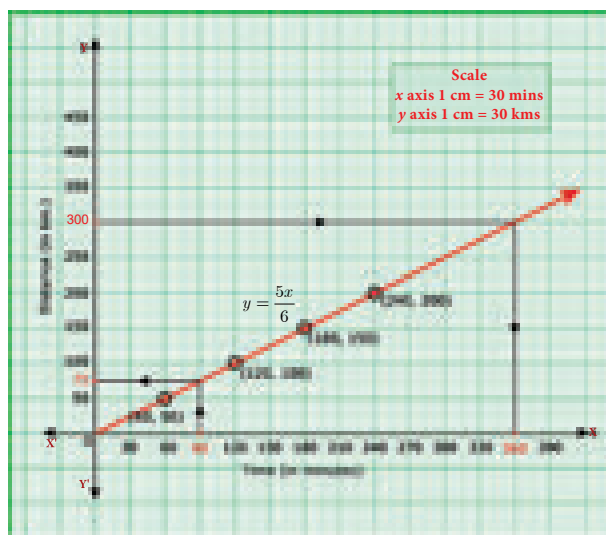

Fig. 3.11

**(ii) Indirect variation:**

The distance between Chennai and Madurai is (nearly) 480 km. Think of a train that starts from Chennai and travels towards Madurai. As it **increases** speed more and more, the time taken for travel will **decrease**. In the following table speed  $v$  is given in km and time  $t$  is given in hours:

<b>Speed (v) (km/hr)</b>	30	40	60	80
<b>Time (t) (hours)</b>	16	12	8	6

From the table it is clear that if you travel at a slower speed, the time increases and if the train is faster, the time decreases. You find,  $30 \times 16 = 40 \times 12 = 60 \times 8 = 80 \times 6$ , which tells that  $vt$  is a constant. Here  $vt = 480$ . In such a case, we say the variables  $v$  and  $t$  are inversely proportional. Observe that the graph of equation like  $vt = 480$  will not be a straight line. Inverse variation implies that as one variable increases, the other variable decreases.

**Visualising Indirect variation:**

Look at the adjacent graph. It is a graph of the equation  $xy = 8$ . We have taken only the [positive values of  $x, y$ .

The table of values is:

<b>x</b>	1	2	4	8
<b><math>y = \frac{8}{x}</math></b>	8	4	2	1

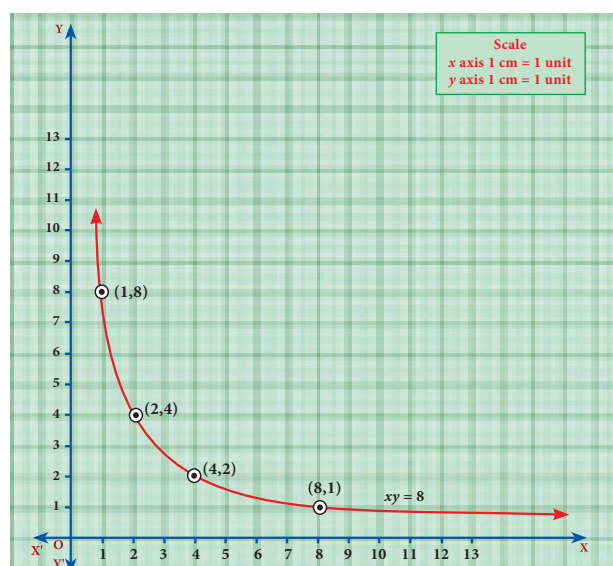

Fig. 3.12

This is an illustration of inverse variation or indirect variation. The graph is a part of a curve called Rectangular Hyperbola.

**Example 3.49** A company initially started with 40 workers to complete the work by 150 days. Later, it decided to fasten up the work increasing the number of workers as shown below.

<b>Number of workers (<math>x</math>)</b>	40	50	60	75
<b>Number of days (<math>y</math>)</b>	150	120	100	80

- Graph the above data and identify the type of variation.
- From the graph, find the number of days required to complete the work if the company decides to opt for 120 workers?
- If the work has to be completed by 200 days, how many workers are required?

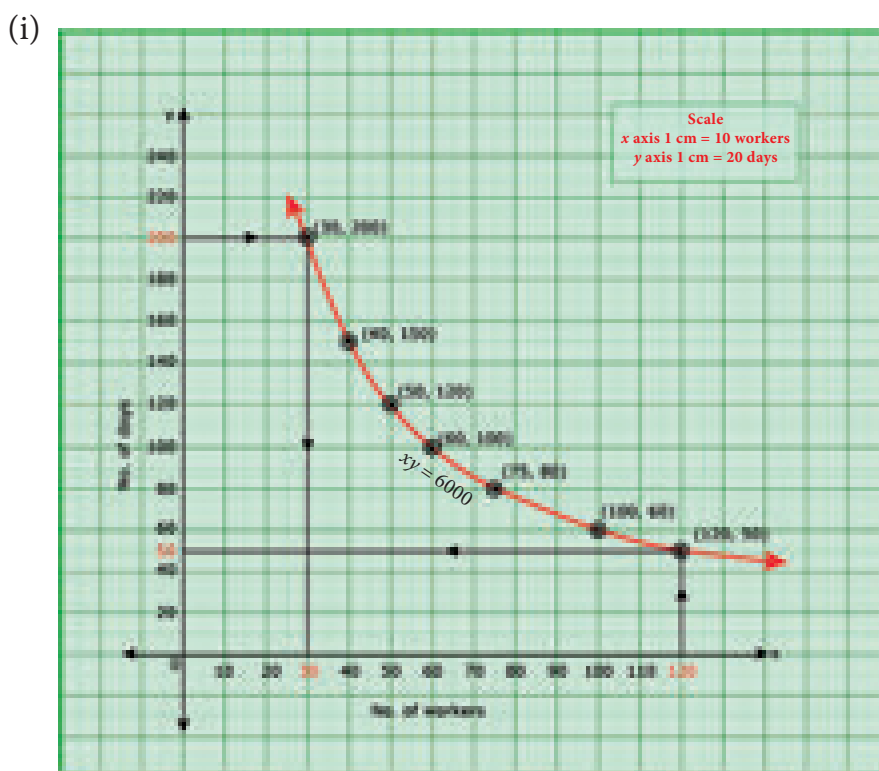

Fig. 3.13

From the given table, we observe that as  $x$  increases,  $y$  decreases. Thus, the variation is an inverse variation.

$$\text{Let } y = \frac{k}{x}$$

$\Rightarrow xy = k, k > 0$  is called the constant of variation.

From the table,  $k = 40 \times 150 = 50 \times 120 = \dots = 75 \times 80 = 6000$

Therefore,  $xy = 6000$

Plot the points (40,150), (50,120), (60,100) of (75,80) and join to get a free hand smooth curve (Rectangular Hyperbola).

(ii) From the graph, the required number of days to complete the work when the company decides to work with 120 workers is 50 days.

Also, from  $xy = 6000$  if  $x = 120$ , then  $y = \frac{6000}{120} = 50$

(iii) From the graph, if the work has to be completed by 200 days, the number of workers required is 30.

Also, from  $xy = 6000$  if  $y = 200$ , then  $x = \frac{6000}{200} = 30$

**Example 3.50**

Nishanth is the winner in a Marathon race of 12 km distance. He ran at the uniform speed of 12 km/hr and reached the destination in 1 hour. He was followed by Aradhana, Jeyanth, Sathya and Swetha with their respective speed of 6 km/hr, 4 km/hr, 3 km/hr and 2 km/hr. And, they covered the distance in 2 hrs, 3 hrs, 4 hrs and 6 hours respectively.

Draw the speed-time graph and use it to find the time taken to Kaushik with his speed of 2.4 km/hr.

**Solution:** Let us form the table with the given details.

<b>Speed <math>x</math> (km/hr)</b>	12	6	4	3	2
<b>Time <math>y</math> (hours)</b>	1	2	3	4	6

From the table, we observe that as  $x$  decreases,  $y$  increases. Hence, the type is **inverse variation**.

Let  $y = \frac{k}{x}$

$\Rightarrow xy = k, k > 0$  is called the constant of variation.

From the table  $k = 12 \times 1 = 6 \times 2 = \dots = 2 \times 6 = 12$

Therefore,  $xy = 12$ .

Plot the points (12,1), (6,2), (4,3), (3,4), (2,6) and join these points by a smooth curve (Rectangular Hyperbola).

From the graph, we observe that Kaushik takes 5 hrs with a speed of 2.4 km/hr.

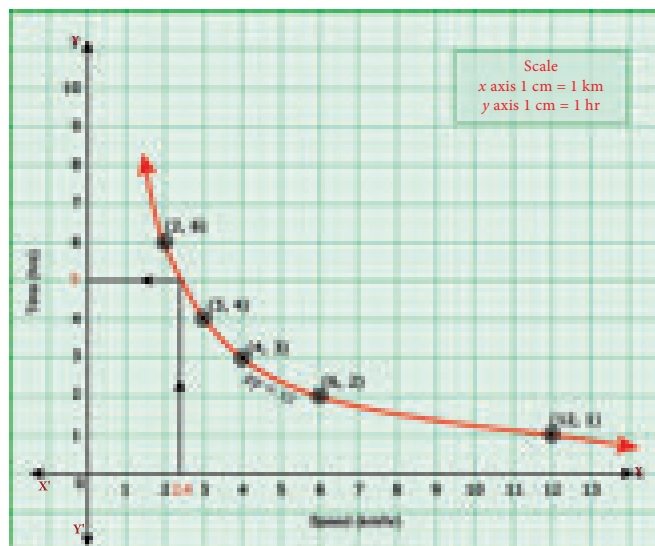

Fig. 3.14

**Note**

Already we learned that, the linear equation of straight line is  $y = mx + c$ , where  $m$  is the slope of the straight line and  $c$  is the  $y$  - intercept. Also, the equation reduces to  $y = mx$  when the straight line passes through origin. As the graph of direct variation refer to straight line and its general form is  $y = kx$ , we can conclude that 'constant of proportionality' is nothing but 'slope' of its straight line.



### Exercise 3.15

- A garment shop announces a flat 50% discount on every purchase of items for their customers. Draw the graph for the relation between the Marked Price and the Discount. Hence find
  - the marked price when a customer gets a discount of ₹3250 (from graph)
  - the discount when the marked price is ₹2500
- Draw the graph of  $xy = 24, x, y > 0$ . Using the graph find,
  - $y$  when  $x = 3$  and (ii)  $x$  when  $y = 6$ .
- Graph the following linear function  $y = \frac{1}{2}x$ . Identify the constant of variation and verify it with the graph. Also (i) find  $y$  when  $x = 9$  (ii) find  $x$  when  $y = 7.5$ .
- The following table shows the data about the number of pipes and the time taken to till the same tank.

No. of pipes ( $x$ )	2	3	6	9
Time Taken (in min) ( $y$ )	45	30	15	10

Draw the graph for the above data and hence

- find the time taken to fill the tank when five pipes are used
  - Find the number of pipes when the time is 9 minutes.
- A school announces that for a certain competitions, the cash price will be distributed for all the participants equally as show below

No. of participants ( $x$ )	2	4	6	8	10
Amount for each participant in ₹ ( $y$ )	180	90	60	45	36

- Find the constant of variation.
  - Graph the above data and hence, find how much will each participant get if the number of participants are 12.
- A two wheeler parking zone near bus stand charges as below.

Time (in hours) ( $x$ )	4	8	12	24
Amount ₹ ( $y$ )	60	120	180	360

Check if the amount charged are in direct variation or in inverse variation to the parking time. Graph the data. Also (i) find the amount to be paid when parking time is 6 hr; (ii) find the parking duration when the amount paid is ₹150.

### 3.8 Quadratic Graphs

#### Introduction

The trajectory followed by an object (say, a ball) thrown upward at an angle gives a curve known as a parabola. Trajectory of water jets in a fountain or of a bouncing ball results in a parabolic path. A parabola represents a **Quadratic function**.

A quadratic function has the form  $f(x) = ax^2 + bx + c$ , where  $a, b, c$  are constants, and  $a \neq 0$ .

Many quadratic functions can be graphed easily by hand using the techniques of stretching/shrinking and shifting the parabola  $y = x^2$  (We can easily sketch the curve  $y = x^2$  by preparing a table of values and plotting the ordered pairs).

The “basic” parabola,  $y = x^2$ , looks like this Fig.3.16.

The coefficient  $a$  in the general equation is responsible for parabolas to open upward or downward and vary in “width” (“wider” or “skinnier”), but they all have the same basic “U” shape.

The greater the quadratic coefficient of  $x^2$ , the narrower is the parabola.

The lesser the quadratic coefficient of  $x^2$ , the wider is the parabola.

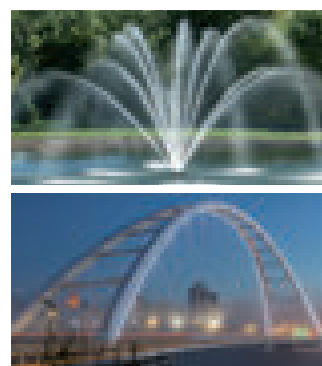

Fig. 3.15

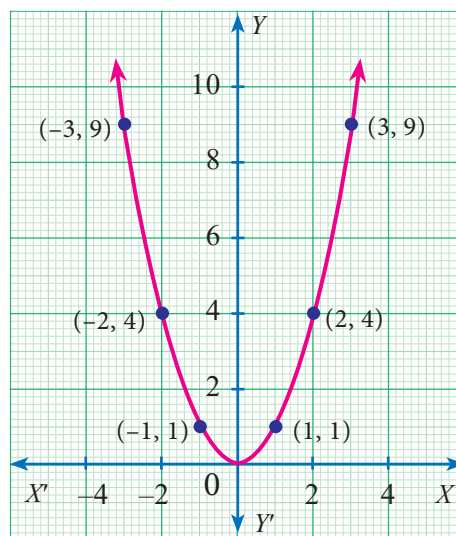

Fig. 3.16

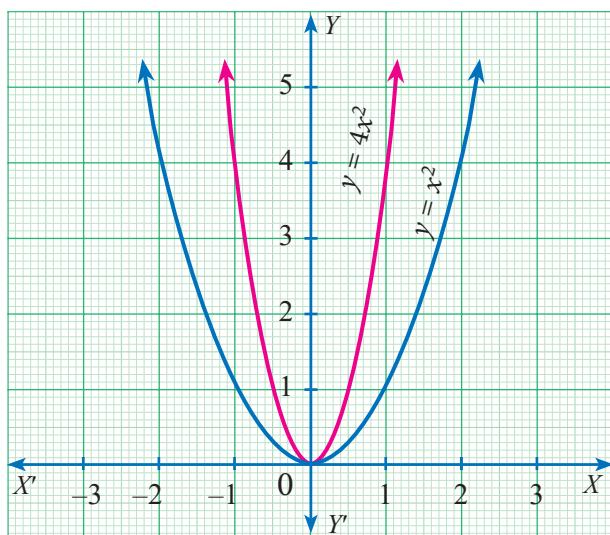

Fig. 3.17

Graph  $y = x^2$  is broader than graph  $y = 4x^2$

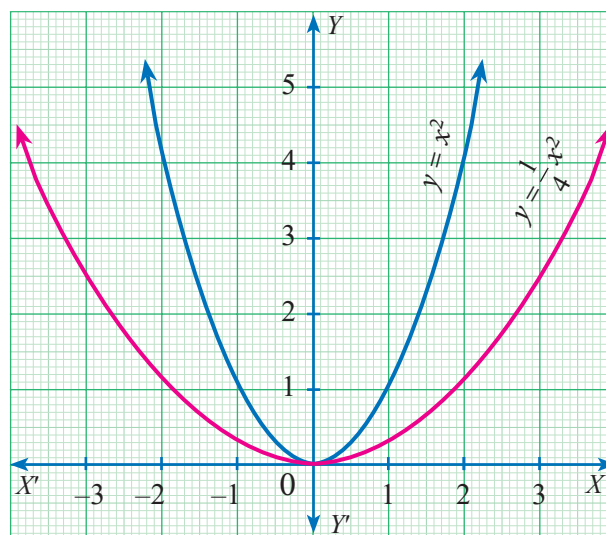

Fig. 3.18

Graph  $y = x^2$  is narrower than graph  $y = \frac{1}{4}x^2$



A parabola is symmetric with respect to a line called the axis of symmetry. The point of intersection of the parabola and the **axis of symmetry** is called the **vertex** of the parabola. The graph of any second degree polynomial gives a curve called “parabola”.

**Hint :** For a quadratic equation , the axis is given by  $x = \frac{-b}{2a}$  and the vertex is given by  $\left(\frac{-b}{2a}, \frac{-\Delta}{4a}\right)$  where  $\Delta = b^2 - 4ac$  is the discriminant of the quadratic equation  $ax^2 + bx + c = 0$ . Where  $a \neq 0$ .

We have already studied how to find the roots of any quadratic equation  $ax^2 + bx + c = 0$  where  $a, b, c \in \mathbb{R}$  and  $a \neq 0$  theoretically. In this section, we will learn how to solve a quadratic equation and obtain its roots graphically.

### 3.8.1 Finding the Nature of Solution of Quadratic Equations Graphically

To obtain the roots of the quadratic equation  $ax^2 + bx + c = 0$  graphically, we first draw the graph of  $y = ax^2 + bx + c$ .

The solutions of the quadratic equation are the  $x$  coordinates of the points of intersection of the curve with  $X$  axis.

To determine the nature of solutions of a quadratic equation, we can use the following procedure.

- (i) If the graph of the given quadratic equation intersect the  $X$  axis at two distinct points, then the given equation has **two real and unequal roots**.
- (ii) If the graph of the given quadratic equation touch the  $X$  axis at only one point, then the given equation has only one root which is same as saying **two real and equal roots**.
- (iii) If the graph of the given equation does not intersect the  $X$  axis at any point then the given equation has **no real root**.

**Example 3.51** Discuss the nature of solutions of the following quadratic equations.

(i)  $x^2 + x - 12 = 0$

(ii)  $x^2 - 8x + 16 = 0$

(iii)  $x^2 + 2x + 5 = 0$

#### Solution

(i)  $x^2 + x - 12 = 0$

**Step 1:** Prepare the table of values for the equation  $y = x^2 + x - 12$ .

$x$	-5	-4	-3	-2	-1	0	1	2	3	4
$y$	8	0	-6	-10	-12	-12	-10	-6	0	8

**Step 2:** Plot the points for the above ordered pairs  $(x, y)$  on the graph using suitable scale.

**Step 3:** Draw the parabola and mark the co-ordinates of the parabola which intersect the X axis.

**Step 4:** The roots of the equation are the  $x$  coordinates of the intersecting points  $(-4, 0)$  and  $(3, 0)$  of the parabola with the X axis which are  $-4$  and  $3$  respectively.

Since there are two points of intersection with the X axis, the quadratic equation  $x^2 + x - 12 = 0$  has **real and unequal roots**.

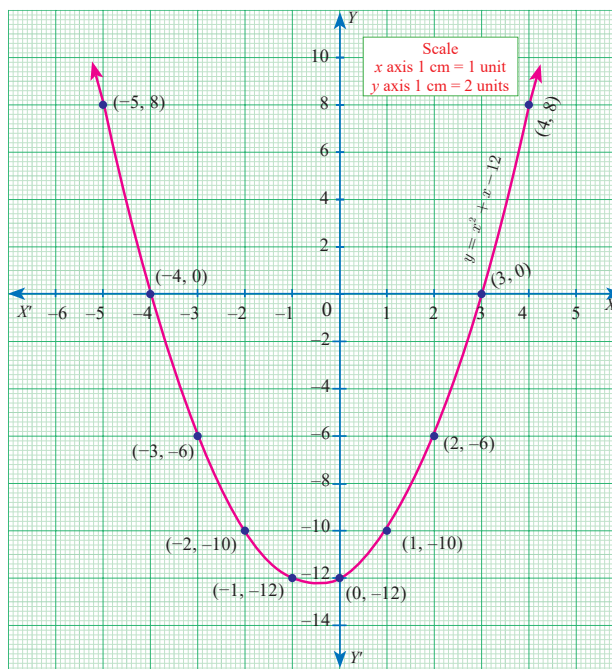

Fig. 3.19

(ii)  $x^2 - 8x + 16 = 0$

**Step 1:** Prepare the table of values for the equation  $y = x^2 - 8x + 16$

$x$	-1	0	1	2	3	4	5	6	7	8
$y$	25	16	9	4	1	0	1	4	9	16

**Step 2:** Plot the points for the above ordered pairs  $(x, y)$  on the graph using suitable scale.

**Step 3:** Draw the parabola and mark the coordinates of the parabola which intersect with the X axis.

**Step 4:** The roots of the equation are the  $x$  coordinates of the intersecting points of the parabola with the X axis  $(4, 0)$  which is  $4$ .

Since there is only one point of intersection with X axis, the quadratic equation  $x^2 - 8x + 16 = 0$  has **real and equal roots**.

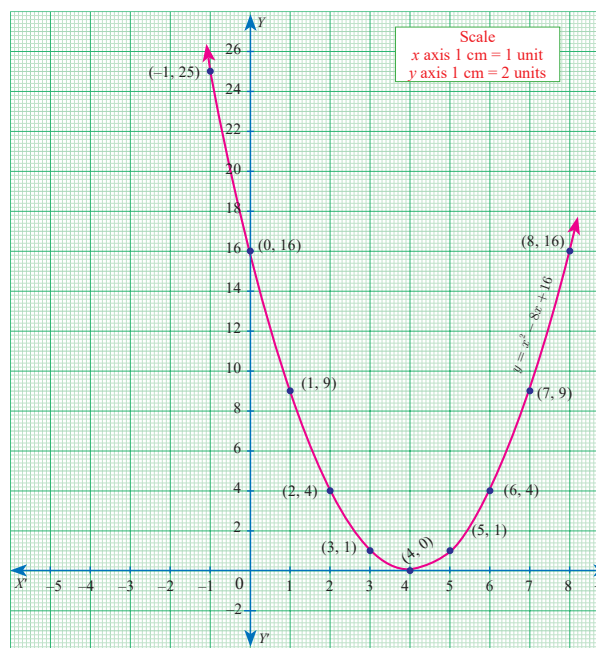

Fig. 3.20

(iii)  $x^2 + 2x + 5 = 0$

Let  $y = x^2 + 2x + 5$

**Step 1:** Prepare a table of values for the equation  $y = x^2 + 2x + 5$

$x$	-3	-2	-1	0	1	2	3
$y$	8	5	4	5	8	13	20



**Step 2:** Plot the above ordered pairs  $(x, y)$  on the graph using suitable scale.

**Step 3:** Join the points by a free-hand smooth curve this smooth curve is the graph of  $y = x^2 + 2x + 5$

**Step 4:** The solutions of the given quadratic equation are the  $x$  coordinates of the intersecting points of the parabola the  $X$  axis.

Here the parabola doesn't intersect or touch the  $X$  axis.

So, we conclude that there is **no real root** for the given quadratic equation.

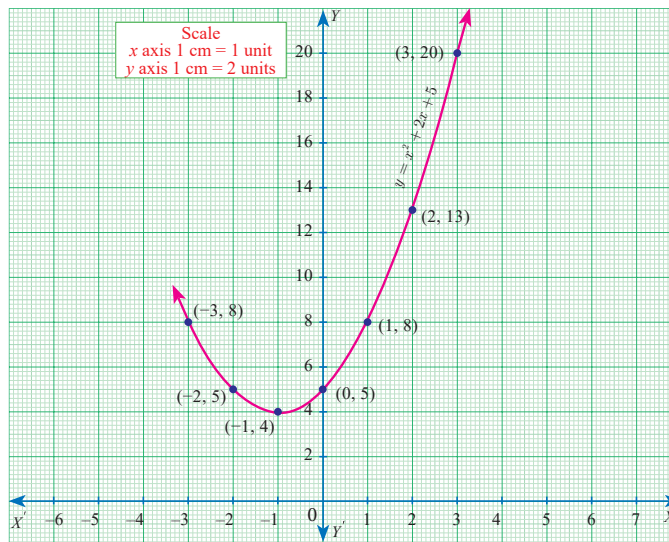

Fig. 3.21



**Progress Check**

Connect the graphs to its respective number of points of intersection with  $X$  axis and to its corresponding nature of solutions which is given in the following table.

S. No.	Graphs	Number of points of Intersection with $X$ axis	Nature of solutions
1.		2	Real and equal roots
2.		1	No real roots
3.		2	No real roots
4.		0	Real and equal roots

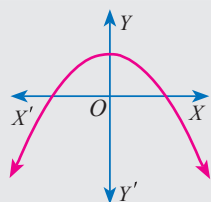
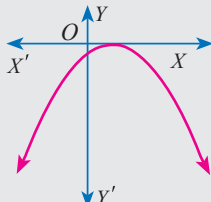
5.		0	Real and unequal roots
6.		1	Real and unequal roots

### 3.8.2 Solving quadratic equations through intersection of lines

We can determine roots of a quadratic equation graphically by choosing appropriate parabola and intersecting it with a desired straight line.

- (i) If the straight line intersects the parabola at two distinct points, then the  $x$  coordinates of those points will be the roots of the given quadratic equation.
- (ii) If the straight line just touch the parabola at only one point, then the  $x$  coordinate of the common point will be the single root of the quadratic equation.
- (iii) If the straight line doesn't intersect or touch the parabola then the quadratic equation will have no real roots.

**Example 3.52** Draw the graph of  $y = 2x^2$  and hence solve  $2x^2 - x - 6 = 0$

**Solution Step 1:** Draw the graph of  $y = 2x^2$  by preparing the table of values as below

$x$	-2	-1	0	1	2
$y$	8	2	0	2	8

**Step 2:** To solve  $2x^2 - x - 6 = 0$ , subtract  $2x^2 - x - 6 = 0$  from  $y = 2x^2$

$$\begin{array}{r}
 y = 2x^2 \\
 0 = 2x^2 - x - 6 \quad (-) \\
 \hline
 y = x + 6
 \end{array}$$

The equation  $y = x + 6$  represents a straight line. Draw the graph of  $y = x + 6$  by forming table of values as below

$x$	-2	-1	0	1	2
$y$	4	5	6	7	8

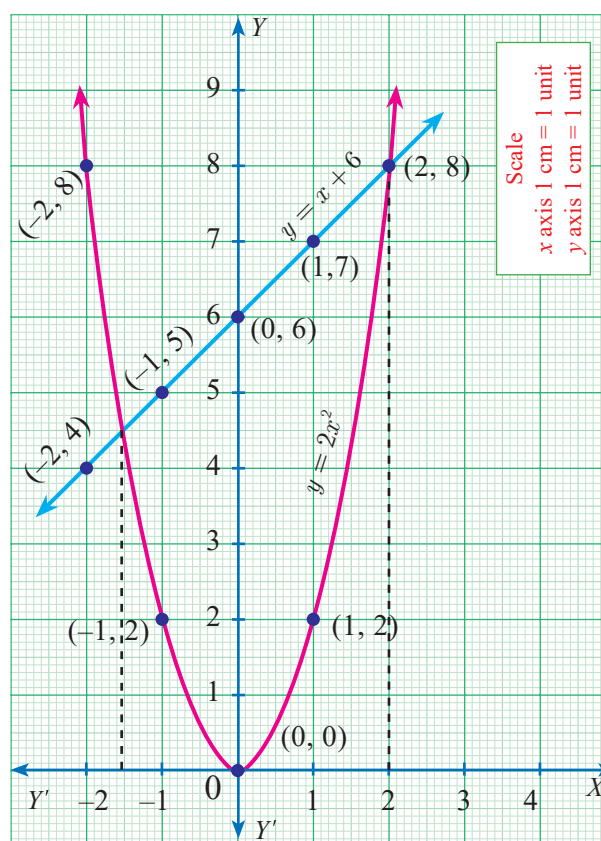

Fig. 3.22

**Step 3:** Mark the points of intersection of the curve  $y = 2x^2$  and the line  $y = x + 6$ . That is,  $(-1.5, 4.5)$  and  $(2, 8)$

**Step 4:** The  $x$  coordinates of the respective points forms the solution set  $\{-1.5, 2\}$  for  $2x^2 - x - 6 = 0$

**Example 3.53** Draw the graph of  $y = x^2 + 4x + 3$  and hence find the roots of  $x^2 + x + 1 = 0$

**Solution**

**Step 1:** Draw the graph of  $y = x^2 + 4x + 3$  by preparing the table of values as below

$x$	-4	-3	-2	-1	0	1	2
$y$	3	0	-1	0	3	8	15

**Step 2:** To solve  $x^2 + x + 1 = 0$ , subtract  $x^2 + x + 1 = 0$  from  $y = x^2 + 4x + 3$

$$\begin{array}{r}
 y = x^2 + 4x + 3 \\
 0 = x^2 + x + 1 \quad (-) \\
 \hline
 y = 3x + 2
 \end{array}$$

The equation represent a straight line. Draw the graph of  $y = 3x + 2$  forming the table of values as below.

$x$	-2	-1	0	1	2
$y$	-4	-1	2	5	8

**Step 3:** Observe that the graph of  $y = 3x + 2$  does not intersect or touch the graph of the parabola  $y = x^2 + 4x + 3$ .

Thus  $x^2 + x + 1 = 0$  has no real roots.

**Example 3.54** Draw the graph of  $y = x^2 + x - 2$  and hence solve  $x^2 + x - 2 = 0$ .

**Solution**

**Step 1:** Draw the graph of  $y = x^2 + x - 2$  by preparing the table of values as below

$x$	-3	-2	-1	0	1	2
$y$	4	0	-2	-2	0	4

**Step 2:** To solve  $x^2 + x - 2 = 0$  subtract  $x^2 + x - 2 = 0$  from  $y = x^2 + x - 2$

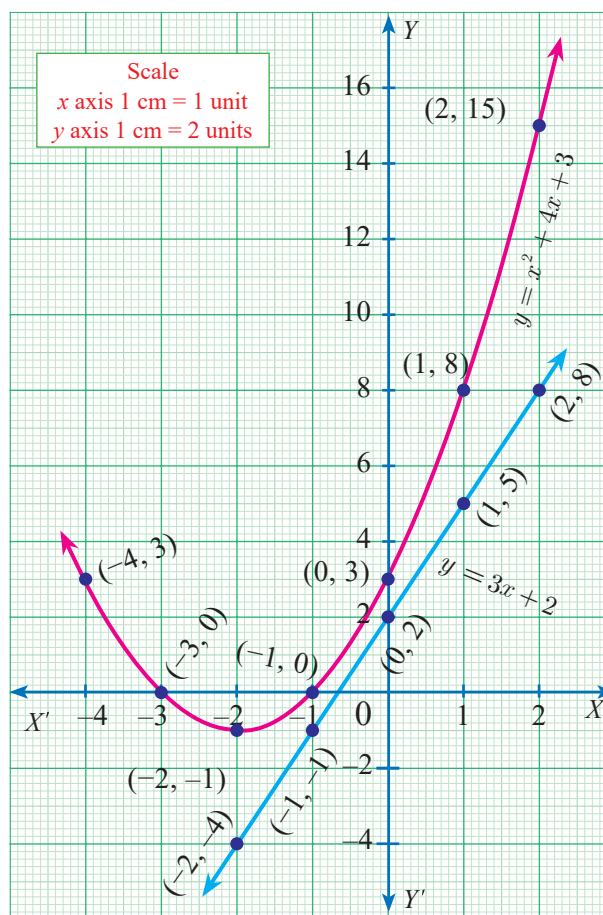

Fig. 3.23

that is

$$y = x^2 + x - 2$$

$$0 = x^2 + x - 2 \quad (-)$$

---

$$y = 0$$

The equation  $y = 0$  represents the X axis.

**Step 3:** Mark the point of intersection of the curve  $y = x^2 + x - 2$  with the X axis. That is  $(-2,0)$  and  $(1,0)$

**Step 4:** The  $x$  coordinates of the respective points form the solution set  $\{-2,1\}$  for  $x^2 + x - 2 = 0$

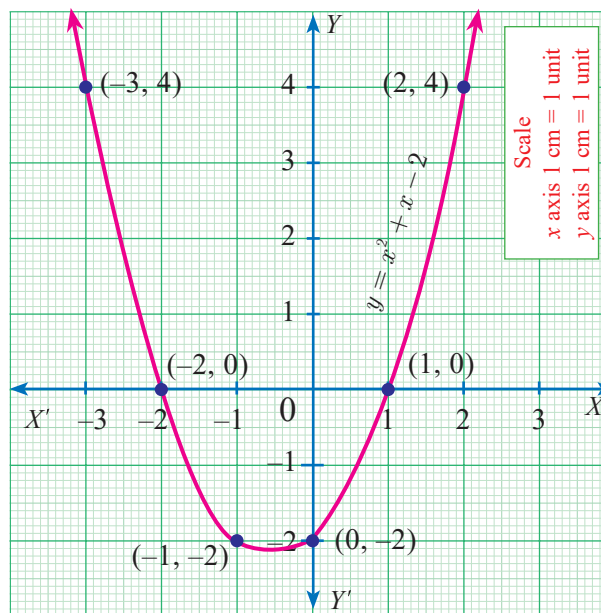

Fig. 3.24

**Example 3.55** Draw the graph of  $y = x^2 - 4x + 3$  and use it to solve  $x^2 - 6x + 9 = 0$

**Solution**

**Step 1:** Draw the graph of  $y = x^2 - 4x + 3$  by preparing the table of values as below

$x$	-2	-1	0	1	2	3	4
$y$	15	8	3	0	-1	0	3

**Step 2:** To solve  $x^2 - 6x + 9 = 0$ , subtract  $x^2 - 6x + 9 = 0$  from  $y = x^2 - 4x + 3$

that is

$$y = x^2 - 4x + 3$$

$$0 = x^2 - 6x + 9 \quad (-)$$

---

$$y = 2x - 6$$

The equation  $y = 2x - 6$  represent a straight line. Draw the graph of  $y = 2x - 6$  forming the table of values as below.

$x$	0	1	2	3	4	5
$y$	-6	-4	-2	0	2	4

The line  $y = 2x - 6$  intersect  $y = x^2 - 4x + 3$  only at one point.

**Step 3:** Mark the point of intersection of the curve  $y = x^2 - 4x + 3$  and  $y = 2x - 6$  that is  $(3,0)$ .

Therefore, the  $x$  coordinate 3 is the only solution for the equation  $x^2 - 6x + 9 = 0$ .

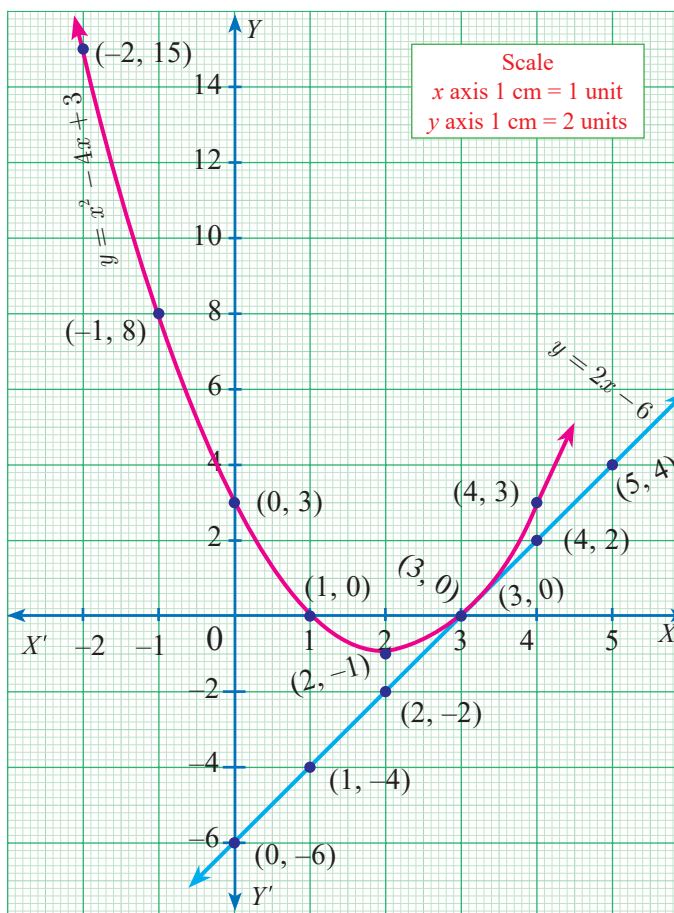

Fig. 3.25



### Exercise 3.16

- Graph the following quadratic equations and state their nature of solutions.
  - $x^2 - 9x + 20 = 0$
  - $x^2 - 4x + 4 = 0$
  - $x^2 + x + 7 = 0$
  - $x^2 - 9 = 0$
  - $x^2 - 6x + 9 = 0$
  - $(2x - 3)(x + 2) = 0$
- Draw the graph of  $y = x^2 - 4$  and hence solve  $x^2 - x - 12 = 0$
- Draw the graph of  $y = x^2 + x$  and hence solve  $x^2 + 1 = 0$
- Draw the graph of  $y = x^2 + 3x + 2$  and use it to solve  $x^2 + 2x + 1 = 0$
- Draw the graph of  $y = x^2 + 3x - 4$  and hence use it to solve  $x^2 + 3x - 4 = 0$
- Draw the graph of  $y = x^2 - 5x - 6$  and hence solve  $x^2 - 5x - 14 = 0$
- Draw the graph of  $y = 2x^2 - 3x - 5$  and hence solve  $2x^2 - 4x - 6 = 0$
- Draw the graph of  $y = (x - 1)(x + 3)$  and hence solve  $x^2 - x - 6 = 0$

## 3.9 Matrices

### Introduction

Let us consider the following information. Vanitha has 12 story books, 20 notebooks and 4 pencils. Radha has 27 story books, 17 notebooks and 6 pencils. Gokul has 7 story books, 11 notebooks and 4 pencils. Geetha has 10 story books, 12 notebooks and 5 pencils.

Details	Story Books	Note Books	Pencils
Vanitha	12	20	4
Radha	27	17	6
Gokul	7	11	4
Geetha	10	12	5

Now we arrange this information in the tabular form as follows.

$$\begin{array}{l}
 \text{First row} \\
 \text{Second row} \\
 \text{Third row} \\
 \text{Fourth row}
 \end{array}
 \begin{pmatrix}
 12 & 20 & 4 \\
 27 & 17 & 6 \\
 7 & 11 & 4 \\
 10 & 12 & 5
 \end{pmatrix}$$

First    Second    Third  
 Column    Column    Column

Here the items possessed by four people are aligned or positioned in a rectangular array containing four horizontal and three vertical arrangements. The horizontal arrangements are called “rows” and the vertical arrangements are called “columns”. The whole rectangular arrangement is called a “Matrix”. Generally, if we arrange things in a rectangular array, we call it as “Matrix”.

Applications of matrices are found in several scientific fields. In Physics, matrices are applied in the calculations of battery power outputs, resistor conversion of electrical

energy into other forms of energy. In computer based applications, matrices play a vital role in the projection of three dimensional image into a two dimensional screen, creating a realistic seeming motions. In graphic software, Matrix Algebra is used to process linear transformations to render images. One of the most important usage of matrices are encryption of message codes. The encryption and decryption process are carried out using matrix multiplication and inverse operations. The concept of matrices is used in transmission of codes when the messages are lengthy. In Geology, matrices are used for taking seismic surveys. In Robotics, matrices are used to identify the robot movements.

### Definition

A matrix is a rectangular array of elements. The horizontal arrangements are called **rows** and vertical arrangements are called **columns**.

For example,  $\begin{pmatrix} 4 & 8 & 0 \\ 1 & 9 & -2 \end{pmatrix}$  is a matrix.

Usually capital letters such as  $A, B, C, X, Y, \dots$  etc., are used to represent the matrices and small letters such as  $a, b, c, l, m, n, a_{12}, a_{13}, \dots$  to indicate the entries or elements of the matrices.

The following are some examples of matrices

$$(i) \begin{pmatrix} 8 & 4 & -1 \\ \frac{1}{2} & 5 & 4 \\ 9 & 0 & 1 \end{pmatrix} \quad (ii) \begin{pmatrix} 1+x & x^3 & \sin x \\ \cos x & 2 & \tan x \end{pmatrix} \quad (iii) \begin{pmatrix} 3+1 & \sqrt{2} & -1 \\ 1.5 & 8 & 9 \\ \frac{1}{3} & 13 & \frac{-7}{9} \end{pmatrix}$$

### 3.9.1 Order of a Matrix

If a matrix  $A$  has  $m$  number of rows and  $n$  number of columns, then the order of the matrix  $A$  is (Number of rows)  $\times$  (Number of columns) that is,  $m \times n$ . We read  $m \times n$  as  $m$  cross  $n$  or  $m$  by  $n$ . It may be noted that  $m \times n$  is not a product of  $m$  and  $n$ .

General form of a matrix  $A$  with  $m$  rows and  $n$  columns (order  $m \times n$ ) can be written in the form

$$A = \begin{pmatrix} a_{11} & a_{12} & \dots & a_{1j} & \dots & a_{1n} \\ a_{21} & a_{22} & \dots & a_{2j} & \dots & a_{2n} \\ \vdots & \vdots & \vdots & \vdots & \vdots & \vdots \\ a_{m1} & a_{m2} & \dots & a_{mj} & \dots & a_{mn} \end{pmatrix}$$

where,  $a_{11}, a_{12}, \dots$  denote entries of the matrix.  $a_{11}$  is the element in first row, first column,  $a_{12}$  is the element in the first row, second column, and so on.



### Progress Check

1. Find is the element in the second row and third column of the

$$\text{matrix } \begin{pmatrix} 1 & -2 & 3 \\ 2 & 1 & 5 \end{pmatrix}$$

2. Find is the order of the matrix

$$\begin{pmatrix} \sin \theta \\ \cos \theta \\ \tan \theta \end{pmatrix}$$

3. Determine the entries denoted by  $a_{11}, a_{22}, a_{33}, a_{44}$  from the matrix

$$\begin{pmatrix} 2 & 1 & 3 & 4 \\ 5 & 9 & -4 & \sqrt{7} \\ 3 & \frac{5}{2} & 8 & 9 \\ 7 & 0 & 1 & 4 \end{pmatrix}$$



In general,  $a_{ij}$  is the element in the  $i^{\text{th}}$  row and  $j^{\text{th}}$  column and is referred as  $(i, j)^{\text{th}}$  element.

With this notation, we can express the matrix  $A$  as  $A = (a_{ij})_{m \times n}$  where  $i = 1, 2, \dots, m$  and  $j = 1, 2, \dots, n$ .

The total number of entries in the matrix  $A = (a_{ij})_{m \times n}$  is  $mn$ .

**Note**



When giving the order of a matrix, you should always mention the number of rows first, followed by the number of columns.

For example,

S.No.	Matrices	Elements of the matrix	Order of the matrix
1.	$\begin{pmatrix} \sin \theta & -\cos \theta \\ \cos \theta & \sin \theta \end{pmatrix}$	$a_{11} = \sin \theta, a_{12} = -\cos \theta,$ $a_{21} = \cos \theta, a_{22} = \sin \theta$	$2 \times 2$
2.	$\begin{pmatrix} 1 & 3 \\ \sqrt{2} & 5 \\ \frac{1}{2} & -4 \end{pmatrix}$	$a_{11} = 1, a_{12} = 3,$ $a_{21} = \sqrt{2}, a_{22} = 5,$ $a_{31} = \frac{1}{2}, a_{32} = -4$	$3 \times 2$



**Activity 4**

- (i) Take calendar sheets of a particular month in a particular year.
- (ii) Construct matrices from the dates of the calendar sheet.
- (iii) Write down the number of possible matrices of orders  $2 \times 2, 3 \times 2, 2 \times 3, 3 \times 3, 4 \times 3$ , etc.
- (iv) Find the maximum possible order of a matrix that you can create from the given calendar sheet.
- (v) Mention the use of matrices to organize information from daily life situations.



**3.9.2 Types of Matrices**

In this section, we shall define certain types of matrices.

**1. Row Matrix**

A matrix is said to be a **row matrix** if it has only one row and any number of columns. A row matrix is also called as a **row vector**.

For example,  $A = (8 \ 9 \ 4 \ 3), B = \left(-\frac{\sqrt{3}}{2} \ 1 \ \sqrt{3}\right)$  are row matrices of order  $1 \times 4$  and  $1 \times 3$  respectively.

In general  $A = (a_{11} \ a_{12} \ a_{13} \ \dots \ a_{1n})$  is a row matrix of order  $1 \times n$ .

**2. Column Matrix**

A matrix is said to be a **column matrix** if it has only one column and any number of rows. It is also called as a **column vector**.



For example,  $A = \begin{pmatrix} \sin x \\ \cos x \\ 1 \end{pmatrix}$ ,  $B = \begin{pmatrix} \sqrt{5} \\ 7 \end{pmatrix}$  and  $C = \begin{pmatrix} 8 \\ -3 \\ 23 \\ 17 \end{pmatrix}$  are column matrices of order  $3 \times 1$ ,  $2 \times 1$  and  $4 \times 1$  respectively.

In general,  $A = \begin{pmatrix} a_{11} \\ a_{21} \\ a_{31} \\ \vdots \\ a_{m1} \end{pmatrix}$  is a column matrix of order  $m \times 1$ .

### 3. Square Matrix

A matrix in which the **number of rows** is equal to the **number of columns** is called a **square matrix**. Thus a matrix  $A = (a_{ij})_{m \times n}$  will be a square matrix if  $m = n$

For example,  $\begin{pmatrix} 1 & 3 \\ 4 & 5 \end{pmatrix}_{2 \times 2}$ ,  $\begin{pmatrix} -1 & 0 & 2 \\ 3 & 6 & 8 \\ 2 & 3 & 5 \end{pmatrix}_{3 \times 3}$  are square matrices.

In general,  $\begin{pmatrix} a_{11} & a_{12} \\ a_{21} & a_{22} \end{pmatrix}_{2 \times 2}$ ,  $\begin{pmatrix} b_{11} & b_{12} & b_{13} \\ b_{21} & b_{22} & b_{23} \\ b_{31} & b_{32} & b_{33} \end{pmatrix}_{3 \times 3}$  are square matrices of orders  $2 \times 2$  and  $3 \times 3$  respectively.

$A = (a_{ij})_{m \times m}$  is a square matrix of order  $m$ .

**Definition :** In a square matrix, the elements of the form  $a_{11}, a_{22}, a_{33}, \dots$  (i.e)  $a_{ii}$  are called leading **diagonal elements**. For example in the matrix  $\begin{pmatrix} 1 & 3 \\ 4 & 5 \end{pmatrix}$ , 1 and 5 are leading diagonal elements.

### 4. Diagonal Matrix

A square matrix, all of whose elements, except those in the leading diagonal are zero is called a **diagonal matrix**.

(ie) A square matrix  $A = (a_{ij})$  is said to be diagonal matrix if  $a_{ij} = 0$  for  $i \neq j$ . Note that some elements of the leading diagonal may be zero but not all.

For example,  $\begin{pmatrix} 8 & 0 & 0 \\ 0 & -3 & 0 \\ 0 & 0 & 11 \end{pmatrix}$ ,  $\begin{pmatrix} 1 & 0 & 0 \\ 0 & 1 & 0 \\ 0 & 0 & 0 \end{pmatrix}$  are diagonal matrices.

### 5. Scalar Matrix

A diagonal matrix in which all the leading diagonal elements are equal is called a **scalar matrix**.

For example,  $\begin{pmatrix} 4 & 0 \\ 0 & 4 \end{pmatrix}$ ,  $\begin{pmatrix} k & 0 & 0 \\ 0 & k & 0 \\ 0 & 0 & k \end{pmatrix}$ ,  $\begin{pmatrix} 5 & 0 & 0 \\ 0 & 5 & 0 \\ 0 & 0 & 5 \end{pmatrix}$

In general,  $A = (a_{ij})_{m \times m}$  is said to be a scalar matrix if

$$a_{ij} = \begin{cases} 0 & \text{when } i \neq j \\ k & \text{when } i = j \end{cases} \text{ where } k \text{ is constant.}$$

## 6. Identity (or) Unit Matrix

A square matrix in which elements in the leading diagonal are all “1” and rest are all zero is called an **identity matrix** or **unit matrix**.

Thus, the square matrix  $A = (a_{ij})$  is an identity matrix if  $a_{ij} = \begin{cases} 1 & \text{if } i = j \\ 0 & \text{if } i \neq j \end{cases}$

A unit matrix of order  $n$  is written as  $I_n$ .

$$I_2 = \begin{pmatrix} 1 & 0 \\ 0 & 1 \end{pmatrix}, \quad I_3 = \begin{pmatrix} 1 & 0 & 0 \\ 0 & 1 & 0 \\ 0 & 0 & 1 \end{pmatrix} \text{ are identity matrices of order 2 and 3 respectively.}$$

## 7. Zero matrix (or) null matrix

A matrix is said to be a **zero matrix** or **null matrix** if all its elements are zero.

For example,  $(0)$ ,  $\begin{pmatrix} 0 & 0 \\ 0 & 0 \end{pmatrix}$ ,  $\begin{pmatrix} 0 & 0 & 0 \\ 0 & 0 & 0 \\ 0 & 0 & 0 \end{pmatrix}$  are all zero matrices of order  $1 \times 1$ ,  $2 \times 2$  and  $3 \times 3$  but of different orders. We denote zero matrix of order  $n \times n$  by  $O_n$ .

$$\begin{pmatrix} 0 & 0 & 0 \\ 0 & 0 & 0 \end{pmatrix} \text{ is a zero matrix of the order } 2 \times 3.$$

## 8. Transpose of a matrix

The matrix which is obtained by interchanging the elements in rows and columns of the given matrix  $A$  is called **transpose of  $A$**  and is denoted by  $A^T$ .

For example,

$$(a) \text{ If } A = \begin{pmatrix} 5 & 3 & -1 \\ 2 & 8 & 9 \\ -4 & 7 & 5 \end{pmatrix}_{3 \times 3} \text{ then } A^T = \begin{pmatrix} 5 & 2 & -4 \\ 3 & 8 & 7 \\ -1 & 9 & 5 \end{pmatrix}_{3 \times 3}$$

$$(b) \text{ If } B = \begin{pmatrix} 1 & 5 \\ 8 & 9 \\ 4 & 3 \end{pmatrix}_{3 \times 2} \text{ then } B^T = \begin{pmatrix} 1 & 8 & 4 \\ 5 & 9 & 3 \end{pmatrix}_{2 \times 3}$$

If order of  $A$  is  $m \times n$  then order of  $A^T$  is  $n \times m$ .

We note that  $(A^T)^T = A$ .

## 9. Triangular Matrix

A square matrix in which all the entries above the leading diagonal are zero is called a **lower triangular matrix**.

If all the entries below the leading diagonal are zero, then it is called an **upper triangular matrix**.

**Definition :** A square matrix  $A = (a_{ij})_{n \times n}$  is called upper triangular matrix if  $a_{ij} = 0$  for  $i > j$  and is called lower triangular matrix if  $a_{ij} = 0, i < j$ .

For example,  $A = \begin{pmatrix} 1 & 7 & -3 \\ 0 & 2 & 4 \\ 0 & 0 & 7 \end{pmatrix}$  is an upper triangular matrix and  $B = \begin{pmatrix} 8 & 0 & 0 \\ 4 & 5 & 0 \\ -11 & 3 & 1 \end{pmatrix}$  is a lower triangular matrix.

### Equal Matrices

Two matrices  $A$  and  $B$  are said to be equal if and only if they have the same order and each element of matrix  $A$  is equal to the corresponding element of matrix  $B$ . That is,  $a_{ij} = b_{ij}$  for all  $i, j$ .

For example, if  $A = \begin{pmatrix} 5 & 1 \\ 0 & 3 \end{pmatrix}$ ,

$B = \begin{pmatrix} 1^2 + 2^2 & \sin^2 \theta + \cos^2 \theta \\ 1 + \frac{3}{2} - \frac{5}{2} & 2 + \sec^2 \theta - \tan^2 \theta \end{pmatrix}$  then we

note that  $A$  and  $B$  have same order and  $a_{ij} = b_{ij}$  for every  $i, j$ . Hence  $A$  and  $B$  are equal matrices.

### The negative of a matrix

The negative of a matrix  $A_{m \times n}$  denoted by  $-A_{m \times n}$  is the matrix formed by replacing each element in the matrix  $A_{m \times n}$  with its additive inverse.

Additive inverse of an element  $k$  is  $-k$ . That is, every element of  $-A$  is the negative of the corresponding element of  $A$ .

For example, if  $A = \begin{pmatrix} 2 & -4 & 9 \\ 5 & -3 & -1 \end{pmatrix}_{2 \times 3}$  then  $-A = \begin{pmatrix} -2 & 4 & -9 \\ -5 & 3 & 1 \end{pmatrix}_{2 \times 3}$

**Example 3.56** Consider the following information regarding the number of men and women workers in three factories I, II and III.

Factory	Men	Women
I	23	18
II	47	36
III	15	16

Represent the above information in the form of a matrix. What does the entry in the second row and first column represent?



### Progress Check

- The number of column(s) in a column matrix are \_\_\_\_\_.
- The number of row(s) in a row matrix are \_\_\_\_\_.
- The non-diagonal elements in any unit matrix are \_\_\_\_\_.
- Does there exist a square matrix with 32 elements?

**Solution** The information is represented in the form of a  $3 \times 2$  matrix as follows

$$A = \begin{pmatrix} 23 & 18 \\ 47 & 36 \\ 15 & 16 \end{pmatrix}$$

The entry in the second row and first column represent that there are 47 men workers in factory II.

**Example 3.57** If a matrix has 16 elements, what are the possible orders it can have?

**Solution** We know that a matrix of order  $m \times n$ , has  $mn$  elements. Thus to find all possible orders of a matrix with 16 elements, we will find all ordered pairs of natural numbers whose product is 16.

Such ordered pairs are (1,16), (16,1), (4,4), (8,2), (2,8)

Hence possible orders are  $1 \times 16$ ,  $16 \times 1$ ,  $4 \times 4$ ,  $2 \times 8$ ,  $8 \times 2$

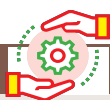

### Activity 5

No.	Elements	Possible orders	Number of possible orders
1.	4		3
2.		$1 \times 9$ , $9 \times 1$ , $3 \times 3$	
3.	20		
4.	8		4
5.	1		
6.	100		
7.		$1 \times 10$ , $10 \times 1$ , $2 \times 5$ , $5 \times 2$	

Do you find any relationship between number of elements (second column) and number of possible orders (fourth column)? If so, what is it?

**Example 3.58** Construct a  $3 \times 3$  matrix whose elements are  $a_{ij} = i^2 j^2$

**Solution** The general  $3 \times 3$  matrix is given by  $A = \begin{pmatrix} a_{11} & a_{12} & a_{13} \\ a_{21} & a_{22} & a_{23} \\ a_{31} & a_{32} & a_{33} \end{pmatrix}$   $a_{ij} = i^2 j^2$

$$a_{11} = 1^2 \times 1^2 = 1 \times 1 = 1; \quad a_{12} = 1^2 \times 2^2 = 1 \times 4 = 4; \quad a_{13} = 1^2 \times 3^2 = 1 \times 9 = 9;$$

$$a_{21} = 2^2 \times 1^2 = 4 \times 1 = 4; \quad a_{22} = 2^2 \times 2^2 = 4 \times 4 = 16; \quad a_{23} = 2^2 \times 3^2 = 4 \times 9 = 36$$

$$a_{31} = 3^2 \times 1^2 = 9 \times 1 = 9; \quad a_{32} = 3^2 \times 2^2 = 9 \times 4 = 36; \quad a_{33} = 3^2 \times 3^2 = 9 \times 9 = 81$$

$$\text{Hence the required matrix is } A = \begin{pmatrix} 1 & 4 & 9 \\ 4 & 16 & 36 \\ 9 & 36 & 81 \end{pmatrix}$$

**Example 3.59** Find the value of  $a$ ,  $b$ ,  $c$ ,  $d$  from the equation  $\begin{pmatrix} a - b & 2a + c \\ 2a - b & 3c + d \end{pmatrix} = \begin{pmatrix} 1 & 5 \\ 0 & 2 \end{pmatrix}$

**Solution** The given matrices are equal. Thus all corresponding elements are equal.

Therefore,  $a - b = 1 \quad \dots(1)$

$$2a + c = 5 \quad \dots(2)$$

$$2a - b = 0 \quad \dots(3)$$

$$3c + d = 2 \quad \dots(4)$$

$$(3) \Rightarrow \begin{aligned} 2a - b &= 0 \\ 2a &= b \quad \dots(5) \end{aligned}$$

Put  $2a = b$  in equation (1),  $a - 2a = 1 \Rightarrow a = -1$

Put  $a = -1$  in equation (5),  $2(-1) = b \Rightarrow b = -2$

Put  $a = -1$  in equation (2),  $2(-1) + c = 5 \Rightarrow c = 7$

Put  $c = 7$  in equation (4),  $3(7) + d = 2 \Rightarrow d = -19$

Therefore,  $a = -1, b = -2, c = 7, d = -19$



### Exercise 3.17

1. In the matrix  $A = \begin{pmatrix} 8 & 9 & 4 & 3 \\ -1 & \sqrt{7} & \frac{\sqrt{3}}{2} & 5 \\ 1 & 4 & 3 & 0 \\ 6 & 8 & -11 & 1 \end{pmatrix}$ , write (i) The number of elements

(ii) The order of the matrix (iii) Write the elements  $a_{22}, a_{23}, a_{24}, a_{34}, a_{43}, a_{44}$ .

2. If a matrix has 18 elements, what are the possible orders it can have? What if it has 6 elements?

3. Construct a  $3 \times 3$  matrix whose elements are given by

(i)  $a_{ij} = |i - 2j|$  (ii)  $a_{ij} = \frac{(i + j)^3}{3}$

4. If  $A = \begin{pmatrix} 5 & 4 & 3 \\ 1 & -7 & 9 \\ 3 & 8 & 2 \end{pmatrix}$  then find the transpose of  $A$ .

5. If  $A = \begin{pmatrix} \sqrt{7} & -3 \\ -\sqrt{5} & 2 \\ \sqrt{3} & -5 \end{pmatrix}$  then find the transpose of  $-A$ .

6. If  $A = \begin{pmatrix} 5 & 2 & 2 \\ -\sqrt{17} & 0.7 & \frac{5}{2} \\ 8 & 3 & 1 \end{pmatrix}$  then verify  $(A^T)^T = A$

7. Find the values of  $x, y$  and  $z$  from the following equations

(i)  $\begin{pmatrix} 12 & 3 \\ x & 5 \end{pmatrix} = \begin{pmatrix} y & z \\ 3 & 5 \end{pmatrix}$  (ii)  $\begin{pmatrix} x + y & 2 \\ 5 + z & xy \end{pmatrix} = \begin{pmatrix} 6 & 2 \\ 5 & 8 \end{pmatrix}$  (iii)  $\begin{pmatrix} x + y + z \\ x + z \\ y + z \end{pmatrix} = \begin{pmatrix} 9 \\ 5 \\ 7 \end{pmatrix}$

### 3.9.3 Operations on Matrices

In this section, we shall discuss the addition and subtraction of matrices, multiplication of a matrix by a scalar and multiplication of matrices.

#### Addition and subtraction of matrices

Two matrices can be added or subtracted if they have the same order. To add or subtract two matrices, simply add or subtract the corresponding elements.

$$\text{For example, } \begin{pmatrix} a & b & c \\ d & e & f \end{pmatrix} + \begin{pmatrix} g & h & i \\ j & k & l \end{pmatrix} = \begin{pmatrix} a+g & b+h & c+i \\ d+j & e+k & f+l \end{pmatrix}$$

$$\begin{pmatrix} a & b \\ c & d \end{pmatrix} - \begin{pmatrix} e & f \\ g & h \end{pmatrix} = \begin{pmatrix} a-e & b-f \\ c-g & d-h \end{pmatrix}$$

If  $A = (a_{ij})$ ,  $B = (b_{ij})$ ,  $i = 1, 2, \dots, m$ ,  $j = 1, 2, \dots, n$  then  $C = A + B$  is such that  $C = (c_{ij})$  where  $c_{ij} = a_{ij} + b_{ij}$  for all  $i = 1, 2, \dots, m$  and  $j = 1, 2, \dots, n$

**Example 3.60** If  $A = \begin{pmatrix} 1 & 2 & 3 \\ 4 & 5 & 6 \\ 7 & 8 & 9 \end{pmatrix}$ ,  $B = \begin{pmatrix} 1 & 7 & 0 \\ 1 & 3 & 1 \\ 2 & 4 & 0 \end{pmatrix}$ , find  $A+B$ .

**Solution**  $A + B = \begin{pmatrix} 1 & 2 & 3 \\ 4 & 5 & 6 \\ 7 & 8 & 9 \end{pmatrix} + \begin{pmatrix} 1 & 7 & 0 \\ 1 & 3 & 1 \\ 2 & 4 & 0 \end{pmatrix} = \begin{pmatrix} 1+1 & 2+7 & 3+0 \\ 4+1 & 5+3 & 6+1 \\ 7+2 & 8+4 & 9+0 \end{pmatrix} = \begin{pmatrix} 2 & 9 & 3 \\ 5 & 8 & 7 \\ 9 & 12 & 9 \end{pmatrix}$

**Example 3.61** Two examinations were conducted for three groups of students namely group 1, group 2, group 3 and their data on average of marks for the subjects Tamil, English, Science and Mathematics are given below in the form of matrices  $A$  and  $B$ . Find the total marks of both the examinations for all the three groups.

$$A = \begin{matrix} & \text{Tamil} & \text{English} & \text{Science} & \text{Mathematics} \\ \text{Group1} & \begin{pmatrix} 22 & 15 & 14 & 23 \end{pmatrix} \\ \text{Group2} & \begin{pmatrix} 50 & 62 & 21 & 30 \end{pmatrix} \\ \text{Group3} & \begin{pmatrix} 53 & 80 & 32 & 40 \end{pmatrix} \end{matrix}$$

$$B = \begin{matrix} & \text{Tamil} & \text{English} & \text{Science} & \text{Mathematics} \\ \text{Group1} & \begin{pmatrix} 20 & 38 & 15 & 40 \end{pmatrix} \\ \text{Group2} & \begin{pmatrix} 18 & 12 & 17 & 80 \end{pmatrix} \\ \text{Group3} & \begin{pmatrix} 81 & 47 & 52 & 18 \end{pmatrix} \end{matrix}$$

**Solution** The total marks in both the examinations for all the three groups is the sum of the given matrices.

$$A + B = \begin{pmatrix} 22+20 & 15+38 & 14+15 & 23+40 \\ 50+18 & 62+12 & 21+17 & 30+80 \\ 53+81 & 80+47 & 32+52 & 40+18 \end{pmatrix} = \begin{pmatrix} 42 & 53 & 29 & 63 \\ 68 & 74 & 38 & 110 \\ 134 & 127 & 84 & 58 \end{pmatrix}$$

**Example 3.62** If  $A = \begin{pmatrix} 1 & 3 & -2 \\ 5 & -4 & 6 \\ -3 & 2 & 9 \end{pmatrix}$ ,  $B = \begin{pmatrix} 1 & 8 \\ 3 & 4 \\ 9 & 6 \end{pmatrix}$ , find  $A+B$ .

**Solution** It is not possible to add  $A$  and  $B$  because they have different orders.

### Multiplication of Matrix by a Scalar

We can multiply the elements of the given matrix  $A$  by a non-zero number  $k$  to obtain a new matrix  $kA$  whose elements are multiplied by  $k$ . The matrix  $kA$  is called scalar multiplication of  $A$ .

Thus if  $A = (a_{ij})_{m \times n}$  then,  $kA = (ka_{ij})_{m \times n}$  for all  $i = 1, 2, \dots, m$  and  $\forall j = 1, 2, \dots, n$ .

**Example 3.63** If  $A = \begin{pmatrix} 7 & 8 & 6 \\ 1 & 3 & 9 \\ -4 & 3 & -1 \end{pmatrix}$ ,  $B = \begin{pmatrix} 4 & 11 & -3 \\ -1 & 2 & 4 \\ 7 & 5 & 0 \end{pmatrix}$  then Find  $2A+B$ .

**Solution** Since  $A$  and  $B$  have same order  $3 \times 3$ ,  $2A + B$  is defined.

$$\begin{aligned} \text{We have } 2A+B &= 2 \begin{pmatrix} 7 & 8 & 6 \\ 1 & 3 & 9 \\ -4 & 3 & -1 \end{pmatrix} + \begin{pmatrix} 4 & 11 & -3 \\ -1 & 2 & 4 \\ 7 & 5 & 0 \end{pmatrix} = \begin{pmatrix} 14 & 16 & 12 \\ 2 & 6 & 18 \\ -8 & 6 & -2 \end{pmatrix} + \begin{pmatrix} 4 & 11 & -3 \\ -1 & 2 & 4 \\ 7 & 5 & 0 \end{pmatrix} \\ &= \begin{pmatrix} 18 & 27 & 9 \\ 1 & 8 & 22 \\ -1 & 11 & -2 \end{pmatrix} \end{aligned}$$

**Example 3.64** If  $A = \begin{pmatrix} 5 & 4 & -2 \\ \frac{1}{2} & \frac{3}{4} & \sqrt{2} \\ 2 & 4 & 1 \end{pmatrix}$ ,  $B = \begin{pmatrix} -7 & 4 & -3 \\ \frac{1}{4} & \frac{7}{2} & 3 \\ 5 & -6 & 9 \end{pmatrix}$ , find  $4A - 3B$ .

**Solution** Since  $A, B$  are of the same order  $3 \times 3$ , subtraction of  $4A$  and  $3B$  is defined.

$$\begin{aligned} 4A - 3B &= 4 \begin{pmatrix} 5 & 4 & -2 \\ \frac{1}{2} & \frac{3}{4} & \sqrt{2} \\ 2 & 4 & 1 \end{pmatrix} - 3 \begin{pmatrix} -7 & 4 & -3 \\ \frac{1}{4} & \frac{7}{2} & 3 \\ 5 & -6 & 9 \end{pmatrix} \\ &= \begin{pmatrix} 20 & 16 & -8 \\ 2 & 3 & 4\sqrt{2} \\ 4 & 36 & 16 \end{pmatrix} + \begin{pmatrix} 21 & -12 & 9 \\ -\frac{3}{4} & -\frac{21}{2} & -9 \\ -15 & 18 & -27 \end{pmatrix} \\ &= \begin{pmatrix} 41 & 4 & 1 \\ \frac{5}{4} & -\frac{15}{2} & 4\sqrt{2} - 9 \\ -11 & 54 & -11 \end{pmatrix} \end{aligned}$$



## Properties of Matrix Addition and Scalar Multiplication

Let  $A, B, C$  be  $m \times n$  matrices and  $p$  and  $q$  be two non-zero scalars (numbers). Then we have the following properties.

- |                                  |   |
|----------------------------------|---|
| (i) $A + B = B + A$              | [Commutative property of matrix addition]               |
| (ii) $A + (B + C) = (A + B) + C$ | [Associative property of matrix addition]               |
| (iii) $(pq)A = p(qA)$            | [Associative property of scalar multiplication]         |
| (iv) $IA = A$                    | [Scalar Identity property where $I$ is the unit matrix] |
| (v) $p(A + B) = pA + pB$         | [Distributive property of scalar and two matrices]      |
| (vi) $(p + q)A = pA + qA$        | [Distributive property of two scalars with a matrix]    |

### Additive Identity

The null matrix or zero matrix is the **identity** for matrix addition.

Let  $A$  be any matrix.

Then,  $A + O = O + A = A$  where  $O$  is the null matrix or zero matrix of same order as that of  $A$ .

### Additive Inverse

If  $A$  be any given matrix then  $-A$  is the **additive inverse** of  $A$ .

In fact we have  $A + (-A) = (-A) + A = O$

**Example 3.65** Find the value of  $a, b, c, d$  from the following matrix equation.

$$\begin{pmatrix} d & 8 \\ 3b & a \end{pmatrix} + \begin{pmatrix} 3 & a \\ -2 & -4 \end{pmatrix} = \begin{pmatrix} 2 & 2a \\ b & 4c \end{pmatrix} + \begin{pmatrix} 0 & 1 \\ -5 & 0 \end{pmatrix}$$

### Solution

First, we add the two matrices on both left, right hand sides to get

$$\begin{pmatrix} d + 3 & 8 + a \\ 3b - 2 & a - 4 \end{pmatrix} = \begin{pmatrix} 2 & 2a + 1 \\ b - 5 & 4c \end{pmatrix}$$

Equating the corresponding elements of the two matrices, we have

$$d + 3 = 2 \quad \Rightarrow \quad d = -1$$

$$8 + a = 2a + 1 \quad \Rightarrow \quad a = 7$$

$$3b - 2 = b - 5 \quad \Rightarrow \quad b = \frac{-3}{2}$$

$$\text{Substituting } a = 7 \text{ in } a - 4 = 4c \Rightarrow c = \frac{3}{4}$$

$$\text{Therefore, } a = 7, b = -\frac{3}{2}, c = \frac{3}{4}, d = -1.$$

**Example 3.66** If  $A = \begin{pmatrix} 1 & 8 & 3 \\ 3 & 5 & 0 \\ 8 & 7 & 6 \end{pmatrix}$ ,  $B = \begin{pmatrix} 8 & -6 & -4 \\ 2 & 11 & -3 \\ 0 & 1 & 5 \end{pmatrix}$ ,  $C = \begin{pmatrix} 5 & 3 & 0 \\ -1 & -7 & 2 \\ 1 & 4 & 3 \end{pmatrix}$

compute the following : (i)  $3A + 2B - C$       (ii)  $\frac{1}{2}A - \frac{3}{2}B$

**Solution** (i)  $3A + 2B - C = 3 \begin{pmatrix} 1 & 8 & 3 \\ 3 & 5 & 0 \\ 8 & 7 & 6 \end{pmatrix} + 2 \begin{pmatrix} 8 & -6 & -4 \\ 2 & 11 & -3 \\ 0 & 1 & 5 \end{pmatrix} - \begin{pmatrix} 5 & 3 & 0 \\ -1 & -7 & 2 \\ 1 & 4 & 3 \end{pmatrix}$

$$= \begin{pmatrix} 3 & 24 & 9 \\ 9 & 15 & 0 \\ 24 & 21 & 18 \end{pmatrix} + \begin{pmatrix} 16 & -12 & -8 \\ 4 & 22 & -6 \\ 0 & 2 & 10 \end{pmatrix} + \begin{pmatrix} -5 & -3 & 0 \\ 1 & 7 & -2 \\ -1 & -4 & -3 \end{pmatrix}$$

$$= \begin{pmatrix} 14 & 9 & 1 \\ 14 & 44 & -8 \\ 23 & 19 & 25 \end{pmatrix}$$

(ii)  $\frac{1}{2}A - \frac{3}{2}B = \frac{1}{2}(A - 3B)$

$$= \frac{1}{2} \left( \begin{pmatrix} 1 & 8 & 3 \\ 3 & 5 & 0 \\ 8 & 7 & 6 \end{pmatrix} - 3 \begin{pmatrix} 8 & -6 & -4 \\ 2 & 11 & -3 \\ 0 & 1 & 5 \end{pmatrix} \right)$$

$$= \frac{1}{2} \left( \begin{pmatrix} 1 & 8 & 3 \\ 3 & 5 & 0 \\ 8 & 7 & 6 \end{pmatrix} + \begin{pmatrix} -24 & 18 & 12 \\ -6 & -33 & 9 \\ 0 & -3 & -15 \end{pmatrix} \right) = \frac{1}{2} \begin{pmatrix} -23 & 26 & 15 \\ -3 & -28 & 9 \\ 8 & 4 & -9 \end{pmatrix}$$

$$= \begin{pmatrix} -\frac{23}{2} & 13 & \frac{15}{2} \\ -\frac{3}{2} & -14 & \frac{9}{2} \\ 4 & 2 & -\frac{9}{2} \end{pmatrix}$$



### Exercise 3.18

1. If  $A = \begin{pmatrix} 1 & 9 \\ 3 & 4 \\ 8 & -3 \end{pmatrix}$ ,  $B = \begin{pmatrix} 5 & 7 \\ 3 & 3 \\ 1 & 0 \end{pmatrix}$  then verify that

(i)  $A + B = B + A$       (ii)  $A + (-A) = (-A) + A = O$ .

2. If  $A = \begin{pmatrix} 4 & 3 & 1 \\ 2 & 3 & -8 \\ 1 & 0 & -4 \end{pmatrix}$ ,  $B = \begin{pmatrix} 2 & 3 & 4 \\ 1 & 9 & 2 \\ -7 & 1 & -1 \end{pmatrix}$  and  $C = \begin{pmatrix} 8 & 3 & 4 \\ 1 & -2 & 3 \\ 2 & 4 & -1 \end{pmatrix}$  then verify that

$A + (B + C) = (A + B) + C$ .

- Find  $X$  and  $Y$  if  $X+Y = \begin{pmatrix} 7 & 0 \\ 3 & 5 \end{pmatrix}$  and  $X-Y = \begin{pmatrix} 3 & 0 \\ 0 & 4 \end{pmatrix}$
- If  $A = \begin{pmatrix} 0 & 4 & 9 \\ 8 & 3 & 7 \end{pmatrix}$ ,  $B = \begin{pmatrix} 7 & 3 & 8 \\ 1 & 4 & 9 \end{pmatrix}$  find the value of (i)  $B - 5A$  (ii)  $3A - 9B$
- Find the values of  $x, y, z$  if (i)  $\begin{pmatrix} x-3 & 3x-z \\ x+y+7 & x+y+z \end{pmatrix} = \begin{pmatrix} 1 & 0 \\ 1 & 6 \end{pmatrix}$   
(ii)  $(x \ y - z \ z + 3) + (y \ 4 \ 3) = (4 \ 8 \ 16)$
- Find  $x$  and  $y$  if  $x \begin{pmatrix} 4 \\ -3 \end{pmatrix} + y \begin{pmatrix} -2 \\ 3 \end{pmatrix} = \begin{pmatrix} 4 \\ 6 \end{pmatrix}$
- Find the non-zero values of  $x$  satisfying the matrix equation  
$$x \begin{pmatrix} 2x & 2 \\ 3 & x \end{pmatrix} + 2 \begin{pmatrix} 8 & 5x \\ 4 & 4x \end{pmatrix} = 2 \begin{pmatrix} x^2 + 8 & 24 \\ 10 & 6x \end{pmatrix}$$
- Solve for  $x, y$ :  $\begin{pmatrix} x^2 \\ y^2 \end{pmatrix} + 2 \begin{pmatrix} -2x \\ -y \end{pmatrix} = \begin{pmatrix} 5 \\ 8 \end{pmatrix}$

### Multiplication of Matrices

To multiply two matrices, the number of columns in the first matrix must be equal to the number of rows in the second matrix. Consider the multiplications of  $3 \times 3$  and  $3 \times 2$  matrices.

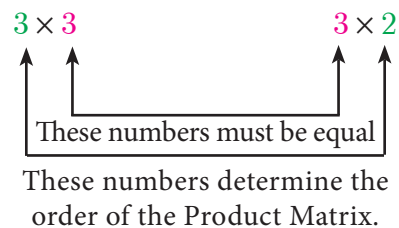

$$(\text{Order of left hand matrix}) \times (\text{order of right hand matrix}) \rightarrow (\text{order of product matrix}).$$

$$(3 \times 3) \quad (3 \times 2) \quad \rightarrow \quad (3 \times 2)$$

Matrices are multiplied by multiplying the elements in a row of the first matrix by the elements in a column of the second matrix, and adding the results.

For example, product of matrices  $\begin{pmatrix} a & b \\ c & d \\ e & f \end{pmatrix} \times \begin{pmatrix} g & h & i \\ k & l & m \end{pmatrix} = \begin{pmatrix} ag + bk & ah + bl & ai + bm \\ cg + dk & ch + dl & ci + dm \\ eg + fk & eh + fl & ei + fm \end{pmatrix}$

The product  $AB$  can be found if the number of columns of matrix  $A$  is equal to the number of rows of matrix  $B$ . If the order of matrix  $A$  is  $m \times n$  and  $B$  is  $n \times p$  then the order of  $AB$  is  $m \times p$ .

### Properties of Multiplication of Matrix

#### (a) Matrix multiplication is not commutative in general

If  $A$  is of order  $m \times n$  and  $B$  of the order  $n \times p$  then  $AB$  is defined but  $BA$  is not defined. Even if  $AB$  and  $BA$  are both defined, it is not necessary that they are equal. In general  $AB \neq BA$ .

**(b) Matrix multiplication is distributive over matrix addition**

- (i) If  $A, B, C$  are  $m \times n, n \times p$  and  $n \times p$  matrices respectively then  
 $A(B + C) = AB + AC$  (Right Distributive Property)
- (ii) If  $A, B, C$  are  $m \times n, m \times n$  and  $n \times p$  matrices respectively then  
 $(A + B)C = AC + BC$  (Left Distributive Property)

**(c) Matrix multiplication is always associative**

If  $A, B, C$  are  $m \times n, n \times p$  and  $p \times q$  matrices respectively then  $(AB)C = A(BC)$

**(d) Multiplication of a matrix by a unit matrix**

If  $A$  is a square matrix of order  $n \times n$  and  $I$  is the unit matrix of same order then  
 $AI = IA = A$ .

**Note**

- If  $x$  and  $y$  are two real numbers such that  $xy = 0$  then either  $x = 0$  or  $y = 0$ . But this condition may not be true with respect to two matrices.
- $AB = 0$  does not necessarily imply that  $A = 0$  or  $B = 0$  or both  $A, B = 0$

**Illustration**

$$A = \begin{pmatrix} 1 & -1 \\ -1 & 1 \end{pmatrix} \neq 0 \quad \text{and} \quad B = \begin{pmatrix} 1 & 1 \\ 1 & 1 \end{pmatrix} \neq 0$$

$$\text{But } AB = \begin{pmatrix} 1 & -1 \\ -1 & 1 \end{pmatrix} \times \begin{pmatrix} 1 & 1 \\ 1 & 1 \end{pmatrix} = \begin{pmatrix} 1-1 & 1-1 \\ -1+1 & -1+1 \end{pmatrix} = \begin{pmatrix} 0 & 0 \\ 0 & 0 \end{pmatrix} = 0$$

Thus  $A \neq 0, B \neq 0$  but  $AB = 0$ .

**Example 3.67** If  $A = \begin{pmatrix} 1 & 2 & 0 \\ 3 & 1 & 5 \end{pmatrix}$ ,  $B = \begin{pmatrix} 8 & 3 & 1 \\ 2 & 4 & 1 \\ 5 & 3 & 1 \end{pmatrix}$ , find  $AB$ .

**Solution** We observe that  $A$  is a  $2 \times 3$  matrix and  $B$  is a  $3 \times 3$  matrix, hence  $AB$  is defined and it will be of the order  $2 \times 3$ .

$$\begin{aligned} \text{Given } A &= \begin{pmatrix} 1 & 2 & 0 \\ 3 & 1 & 5 \end{pmatrix}_{2 \times 3}, B = \begin{pmatrix} 8 & 3 & 1 \\ 2 & 4 & 1 \\ 5 & 3 & 1 \end{pmatrix}_{3 \times 3} \\ AB &= \begin{pmatrix} 1 & 2 & 0 \\ 3 & 1 & 5 \end{pmatrix} \times \begin{pmatrix} 8 & 3 & 1 \\ 2 & 4 & 1 \\ 5 & 3 & 1 \end{pmatrix} \\ &= \begin{pmatrix} 8+4+0 & 3+8+0 & 1+2+0 \\ 24+2+25 & 9+4+15 & 3+1+5 \end{pmatrix} = \begin{pmatrix} 12 & 11 & 3 \\ 51 & 28 & 9 \end{pmatrix} \end{aligned}$$

**Example 3.68** If  $A = \begin{pmatrix} 2 & 1 \\ 1 & 3 \end{pmatrix}$ ,  $B = \begin{pmatrix} 2 & 0 \\ 1 & 3 \end{pmatrix}$  find  $AB$  and  $BA$ . Verify  $AB = BA$ ?

**Solution** We observe that  $A$  is a  $2 \times 2$  matrix and  $B$  is a  $2 \times 2$  matrix, hence  $AB$  is defined and it will be of the order  $2 \times 2$ .

$$AB = \begin{pmatrix} 2 & 1 \\ 1 & 3 \end{pmatrix} \times \begin{pmatrix} 2 & 0 \\ 1 & 3 \end{pmatrix} = \begin{pmatrix} 4+1 & 0+3 \\ 2+3 & 0+9 \end{pmatrix} = \begin{pmatrix} 5 & 3 \\ 5 & 9 \end{pmatrix}$$

$$BA = \begin{pmatrix} 2 & 0 \\ 1 & 3 \end{pmatrix} \times \begin{pmatrix} 2 & 1 \\ 1 & 3 \end{pmatrix} = \begin{pmatrix} 4+0 & 2+0 \\ 2+3 & 1+9 \end{pmatrix} = \begin{pmatrix} 4 & 2 \\ 5 & 10 \end{pmatrix}$$

Therefore,  $AB \neq BA$ .

**Example 3.69** If  $A = \begin{pmatrix} 2 & -2\sqrt{2} \\ \sqrt{2} & 2 \end{pmatrix}$  and  $B = \begin{pmatrix} 2 & 2\sqrt{2} \\ -\sqrt{2} & 2 \end{pmatrix}$

Show that  $A$  and  $B$  satisfy commutative property with respect to matrix multiplication.

**Solution** We have to show that  $AB = BA$

$$\left. \begin{aligned} \text{LHS} = AB &= \begin{pmatrix} 2 & -2\sqrt{2} \\ \sqrt{2} & 2 \end{pmatrix} \times \begin{pmatrix} 2 & 2\sqrt{2} \\ -\sqrt{2} & 2 \end{pmatrix} \\ &= \begin{pmatrix} 4+4 & 4\sqrt{2}-4\sqrt{2} \\ 2\sqrt{2}-2\sqrt{2} & 4+4 \end{pmatrix} \\ &= \begin{pmatrix} 8 & 0 \\ 0 & 8 \end{pmatrix} \end{aligned} \right\} \begin{aligned} \text{RHS} = BA &= \begin{pmatrix} 2 & 2\sqrt{2} \\ -\sqrt{2} & 2 \end{pmatrix} \times \begin{pmatrix} 2 & -2\sqrt{2} \\ \sqrt{2} & 2 \end{pmatrix} \\ &= \begin{pmatrix} 4+4 & -4\sqrt{2}+4\sqrt{2} \\ -2\sqrt{2}+2\sqrt{2} & 4+4 \end{pmatrix} \\ &= \begin{pmatrix} 8 & 0 \\ 0 & 8 \end{pmatrix} \end{aligned}$$

Hence LHS = RHS (ie)  $AB = BA$

**Example 3.70** Solve  $\begin{pmatrix} 2 & 1 \\ 1 & 2 \end{pmatrix} \begin{pmatrix} x \\ y \end{pmatrix} = \begin{pmatrix} 4 \\ 5 \end{pmatrix}$

**Solution**  $\begin{pmatrix} 2 & 1 \\ 1 & 2 \end{pmatrix}_{2 \times 2} \times \begin{pmatrix} x \\ y \end{pmatrix}_{2 \times 1} = \begin{pmatrix} 4 \\ 5 \end{pmatrix}$

By matrix multiplication  $\begin{pmatrix} 2x+y \\ x+2y \end{pmatrix} = \begin{pmatrix} 4 \\ 5 \end{pmatrix}$

Rewriting  $2x + y = 4$  ... (1)

$x + 2y = 5$  ... (2)

(1)  $-2 \times$  (2)  $\Rightarrow$   $2x + y = 4$   
 $2x + 4y = 10$  (-)

$-3y = -6 \Rightarrow y = 2$

### Note

- If  $A$  and  $B$  are any two non zero matrices, then  $(A+B)^2 \neq A^2 + 2AB + B^2$ .
- However if  $AB = BA$  then  $(A+B)^2 = A^2 + 2AB + B^2$

Substituting  $y = 2$  in (1),  $2x + 2 = 4 \Rightarrow x = 1$

Therefore,  $x = 1, y = 2$ .

**Example 3.71** If  $A = \begin{pmatrix} 1 & -1 & 2 \end{pmatrix}$ ,  $B = \begin{pmatrix} 1 & -1 \\ 2 & 1 \\ 1 & 3 \end{pmatrix}$  and  $C = \begin{pmatrix} 1 & 2 \\ 2 & -1 \end{pmatrix}$

show that  $(AB)C = A(BC)$ .

**Solution** LHS =  $(AB)C$

$$AB = \begin{pmatrix} 1 & -1 & 2 \end{pmatrix}_{1 \times 3} \times \begin{pmatrix} 1 & -1 \\ 2 & 1 \\ 1 & 3 \end{pmatrix}_{3 \times 2} = (1 - 2 + 2 \quad -1 - 1 + 6) = (1 \quad 4)$$

$$(AB)C = \begin{pmatrix} 1 & 4 \end{pmatrix}_{1 \times 2} \times \begin{pmatrix} 1 & 2 \\ 2 & -1 \end{pmatrix}_{2 \times 2} = (1 + 8 \quad 2 - 4) = (9 \quad -2) \quad \dots(1)$$

RHS =  $A(BC)$

$$BC = \begin{pmatrix} 1 & -1 \\ 2 & 1 \\ 1 & 3 \end{pmatrix}_{3 \times 2} \times \begin{pmatrix} 1 & 2 \\ 2 & -1 \end{pmatrix}_{2 \times 2} = \begin{pmatrix} 1 - 2 & 2 + 1 \\ 2 + 2 & 4 - 1 \\ 1 + 6 & 2 - 3 \end{pmatrix} = \begin{pmatrix} -1 & 3 \\ 4 & 3 \\ 7 & -1 \end{pmatrix}$$

$$A(BC) = \begin{pmatrix} 1 & -1 & 2 \end{pmatrix}_{1 \times 3} \times \begin{pmatrix} -1 & 3 \\ 4 & 3 \\ 7 & -1 \end{pmatrix}_{3 \times 2}$$

$$A(BC) = (-1 - 4 + 14 \quad 3 - 3 - 2) = (9 \quad -2) \quad \dots(2)$$

From (1) and (2),  $(AB)C = A(BC)$ .

**Example 3.72** If  $A = \begin{pmatrix} 1 & 1 \\ -1 & 3 \end{pmatrix}$ ,  $B = \begin{pmatrix} 1 & 2 \\ -4 & 2 \end{pmatrix}$ ,  $C = \begin{pmatrix} -7 & 6 \\ 3 & 2 \end{pmatrix}$  verify that  $A(B + C) = AB + AC$ .

**Solution** LHS =  $A(B + C)$

$$B + C = \begin{pmatrix} 1 & 2 \\ -4 & 2 \end{pmatrix} + \begin{pmatrix} -7 & 6 \\ 3 & 2 \end{pmatrix} = \begin{pmatrix} -6 & 8 \\ -1 & 4 \end{pmatrix}$$

$$A(B + C) = \begin{pmatrix} 1 & 1 \\ -1 & 3 \end{pmatrix} \times \begin{pmatrix} -6 & 8 \\ -1 & 4 \end{pmatrix} = \begin{pmatrix} -6 - 1 & 8 + 4 \\ 6 - 3 & -8 + 12 \end{pmatrix} = \begin{pmatrix} -7 & 12 \\ 3 & 4 \end{pmatrix} \quad \dots(1)$$

RHS =  $AB + AC$

$$AB = \begin{pmatrix} 1 & 1 \\ -1 & 3 \end{pmatrix} \times \begin{pmatrix} 1 & 2 \\ -4 & 2 \end{pmatrix} = \begin{pmatrix} 1 - 4 & 2 + 2 \\ -1 - 12 & -2 + 6 \end{pmatrix} = \begin{pmatrix} -3 & 4 \\ -13 & 4 \end{pmatrix}$$

$$AC = \begin{pmatrix} 1 & 1 \\ -1 & 3 \end{pmatrix} \times \begin{pmatrix} -7 & 6 \\ 3 & 2 \end{pmatrix} = \begin{pmatrix} -7 + 3 & 6 + 2 \\ 7 + 9 & -6 + 6 \end{pmatrix} = \begin{pmatrix} -4 & 8 \\ 16 & 0 \end{pmatrix}$$

Therefore,  $AB + AC = \begin{pmatrix} -3 & 4 \\ -13 & 4 \end{pmatrix} + \begin{pmatrix} -4 & 8 \\ 16 & 0 \end{pmatrix} = \begin{pmatrix} -7 & 12 \\ 3 & 4 \end{pmatrix}$  ... (2)

From (1) and (2),  $A(B + C) = AB + AC$ . Hence proved.

**Example 3.73** If  $A = \begin{pmatrix} 1 & 2 & 1 \\ 2 & -1 & 1 \end{pmatrix}$  and  $B = \begin{pmatrix} 2 & -1 \\ -1 & 4 \\ 0 & 2 \end{pmatrix}$  show that  $(AB)^T = B^T A^T$

**Solution**

LHS =  $(AB)^T$

$$AB = \begin{pmatrix} 1 & 2 & 1 \\ 2 & -1 & 1 \end{pmatrix}_{2 \times 3} \times \begin{pmatrix} 2 & -1 \\ -1 & 4 \\ 0 & 2 \end{pmatrix}_{3 \times 2}$$

$$= \begin{pmatrix} 2-2+0 & -1+8+2 \\ 4+1+0 & -2-4+2 \end{pmatrix} = \begin{pmatrix} 0 & 9 \\ 5 & -4 \end{pmatrix}$$

$$(AB)^T = \begin{pmatrix} 0 & 9 \\ 5 & -4 \end{pmatrix}^T = \begin{pmatrix} 0 & 5 \\ 9 & -4 \end{pmatrix} \quad \dots(1)$$

RHS =  $(B^T A^T)$

$$B^T = \begin{pmatrix} 2 & -1 & 0 \\ -1 & 4 & 2 \end{pmatrix}, A^T = \begin{pmatrix} 1 & 2 \\ 2 & -1 \\ 1 & 1 \end{pmatrix}$$

$$B^T A^T = \begin{pmatrix} 2 & -1 & 0 \\ -1 & 4 & 2 \end{pmatrix}_{2 \times 3} \times \begin{pmatrix} 1 & 2 \\ 2 & -1 \\ 1 & 1 \end{pmatrix}_{3 \times 2}$$

$$= \begin{pmatrix} 2-2+0 & 4+1+0 \\ -1+8+2 & -2-4+2 \end{pmatrix}$$

$$B^T A^T = \begin{pmatrix} 0 & 5 \\ 9 & -4 \end{pmatrix} \quad \dots(2)$$

From (1) and (2),  $(AB)^T = B^T A^T$ .

Hence proved.



**Exercise 3.19**

1. Find the order of the product matrix  $AB$  if

	(i)	(ii)	(iii)	(iv)	(v)
<b>Orders of A</b>	3×3	4×3	4×2	4×5	1×1
<b>Orders of B</b>	3×3	3×2	2×2	5×1	1×3

- If  $A$  is of order  $p \times q$  and  $B$  is of order  $q \times r$  what is the order of  $AB$  and  $BA$ ?
- $A$  has 'a' rows and 'a + 3' columns.  $B$  has 'b' rows and '17-b' columns, and if both products  $AB$  and  $BA$  exist, find  $a, b$ ?

4. If  $A = \begin{pmatrix} 2 & 5 \\ 4 & 3 \end{pmatrix}$ ,  $B = \begin{pmatrix} 1 & -3 \\ 2 & 5 \end{pmatrix}$  find  $AB, BA$  and verify  $AB = BA$ ?

5. Given that  $A = \begin{pmatrix} 1 & 3 \\ 5 & -1 \end{pmatrix}$ ,  $B = \begin{pmatrix} 1 & -1 & 2 \\ 3 & 5 & 2 \end{pmatrix}$ ,  $C = \begin{pmatrix} 1 & 3 & 2 \\ -4 & 1 & 3 \end{pmatrix}$

verify that  $A(B + C) = AB + AC$ .

6. Show that the matrices  $A = \begin{pmatrix} 1 & 2 \\ 3 & 1 \end{pmatrix}$ ,  $B = \begin{pmatrix} 1 & -2 \\ -3 & 1 \end{pmatrix}$  satisfy commutative property  $AB=BA$
7. Let  $A = \begin{pmatrix} 1 & 2 \\ 1 & 3 \end{pmatrix}$ ,  $B = \begin{pmatrix} 4 & 0 \\ 1 & 5 \end{pmatrix}$ ,  $C = \begin{pmatrix} 2 & 0 \\ 1 & 2 \end{pmatrix}$  Show that (i)  $A(BC) = (AB)C$   
(ii)  $(A - B)C = AC - BC$  (iii)  $(A - B)^T = A^T - B^T$
8. If  $A = \begin{pmatrix} \cos \theta & 0 \\ 0 & \cos \theta \end{pmatrix}$ ,  $B = \begin{pmatrix} \sin \theta & 0 \\ 0 & \sin \theta \end{pmatrix}$  then show that  $A^2 + B^2 = I$ .
9. If  $A = \begin{pmatrix} \cos \theta & \sin \theta \\ -\sin \theta & \cos \theta \end{pmatrix}$  prove that  $AA^T = I$ .
10. Verify that  $A^2 = I$  when  $A = \begin{pmatrix} 5 & -4 \\ 6 & -5 \end{pmatrix}$
11. If  $A = \begin{pmatrix} a & b \\ c & d \end{pmatrix}$  and  $I = \begin{pmatrix} 1 & 0 \\ 0 & 1 \end{pmatrix}$  show that  $A^2 - (a + d)A = (bc - ad)I_2$
12. If  $A = \begin{pmatrix} 5 & 2 & 9 \\ 1 & 2 & 8 \end{pmatrix}$ ,  $B = \begin{pmatrix} 1 & 7 \\ 1 & 2 \\ 5 & -1 \end{pmatrix}$  verify that  $(AB)^T = B^T A^T$
13. If  $A = \begin{pmatrix} 3 & 1 \\ -1 & 2 \end{pmatrix}$  show that  $A^2 - 5A + 7I_2 = 0$



### Exercise 3.20



### Multiple choice questions

- A system of three linear equations in three variables is inconsistent if their planes
  - intersect only at a point
  - intersect in a line
  - coincides with each other
  - do not intersect
- The solution of the system  $x + y - 3z = -6$ ,  $-7y + 7z = 7$ ,  $3z = 9$  is
  - $x = 1, y = 2, z = 3$
  - $x = -1, y = 2, z = 3$
  - $x = -1, y = -2, z = 3$
  - $x = 1, y = -2, z = 3$
- If  $(x - 6)$  is the HCF of  $x^2 - 2x - 24$  and  $x^2 - kx - 6$  then the value of  $k$  is
  - 3
  - 5
  - 6
  - 8
- $\frac{3y - 3}{y} \div \frac{7y - 7}{3y^2}$  is
  - $\frac{9y}{7}$
  - $\frac{9y^3}{(21y - 21)}$
  - $\frac{21y^2 - 42y + 21}{3y^3}$
  - $\frac{7(y^2 - 2y + 1)}{y^2}$



5.  $y^2 + \frac{1}{y^2}$  is not equal to  
 (A)  $\frac{y^4 + 1}{y^2}$  (B)  $\left(y + \frac{1}{y}\right)^2$  (C)  $\left(y - \frac{1}{y}\right)^2 + 2$  (D)  $\left(y + \frac{1}{y}\right)^2 - 2$
6.  $\frac{x}{x^2 - 25} - \frac{8}{x^2 + 6x + 5}$  gives  
 (A)  $\frac{x^2 - 7x + 40}{(x - 5)(x + 5)}$  (B)  $\frac{x^2 + 7x + 40}{(x - 5)(x + 5)(x + 1)}$   
 (C)  $\frac{x^2 - 7x + 40}{(x^2 - 25)(x + 1)}$  (D)  $\frac{x^2 + 10}{(x^2 - 25)(x + 1)}$
7. The square root of  $\frac{256x^8y^4z^{10}}{25x^6y^6z^6}$  is equal to  
 (A)  $\frac{16}{5} \left| \frac{x^2z^4}{y^2} \right|$  (B)  $16 \left| \frac{y^2}{x^2z^4} \right|$  (C)  $\frac{16}{5} \left| \frac{y}{xz^2} \right|$  (D)  $\frac{16}{5} \left| \frac{xz^2}{y} \right|$
8. Which of the following should be added to make  $x^4 + 64$  a perfect square  
 (A)  $4x^2$  (B)  $16x^2$  (C)  $8x^2$  (D)  $-8x^2$
9. The solution of  $(2x - 1)^2 = 9$  is equal to  
 (A)  $-1$  (B)  $2$  (C)  $-1, 2$  (D) None of these
10. The values of  $a$  and  $b$  if  $4x^4 - 24x^3 + 76x^2 + ax + b$  is a perfect square are  
 (A) 100,120 (B) 10,12 (C)  $-120,100$  (D) 12,10
11. If the roots of the equation  $q^2x^2 + p^2x + r^2 = 0$  are the squares of the roots of the equation  $qx^2 + px + r = 0$ , then  $q, p, r$  are in \_\_\_\_\_  
 (A)  $A.P$  (B)  $G.P$  (C) Both  $A.P$  and  $G.P$  (D) none of these
12. Graph of a linear equation is a \_\_\_\_\_  
 (A) straight line (B) circle (C) parabola (D) hyperbola
13. The number of points of intersection of the quadratic polynomial  $x^2 + 4x + 4$  with the  $X$  axis is  
 (A) 0 (B) 1 (C) 0 or 1 (D) 2
14. For the given matrix  $A = \begin{pmatrix} 1 & 3 & 5 & 7 \\ 2 & 4 & 6 & 8 \\ 9 & 11 & 13 & 15 \end{pmatrix}$  the order of the matrix  $A^T$  is  
 (A)  $2 \times 3$  (B)  $3 \times 2$  (C)  $3 \times 4$  (D)  $4 \times 3$
15. If  $A$  is a  $2 \times 3$  matrix and  $B$  is a  $3 \times 4$  matrix, how many columns does  $AB$  have  
 (A) 3 (B) 4 (C) 2 (D) 5

16. If number of columns and rows are not equal in a matrix then it is said to be a  
 (A) diagonal matrix (B) rectangular matrix  
 (C) square matrix (D) identity matrix

17. Transpose of a column matrix is  
 (A) unit matrix (B) diagonal matrix  
 (C) column matrix (D) row matrix

18. Find the matrix  $X$  if  $2X + \begin{pmatrix} 1 & 3 \\ 5 & 7 \end{pmatrix} = \begin{pmatrix} 5 & 7 \\ 9 & 5 \end{pmatrix}$   
 (A)  $\begin{pmatrix} -2 & -2 \\ 2 & -1 \end{pmatrix}$  (B)  $\begin{pmatrix} 2 & 2 \\ 2 & -1 \end{pmatrix}$  (C)  $\begin{pmatrix} 1 & 2 \\ 2 & 2 \end{pmatrix}$  (D)  $\begin{pmatrix} 2 & 1 \\ 2 & 2 \end{pmatrix}$

19. Which of the following can be calculated from the given matrices

$$A = \begin{pmatrix} 1 & 2 \\ 3 & 4 \\ 5 & 6 \end{pmatrix}, B = \begin{pmatrix} 1 & 2 & 3 \\ 4 & 5 & 6 \\ 7 & 8 & 9 \end{pmatrix}, \text{ (i) } A^2 \text{ (ii) } B^2 \text{ (iii) } AB \text{ (iv) } BA$$

- (A) (i) and (ii) only (B) (ii) and (iii) only  
 (C) (ii) and (iv) only (D) all of these

20. If  $A = \begin{pmatrix} 1 & 2 & 3 \\ 3 & 2 & 1 \end{pmatrix}$ ,  $B = \begin{pmatrix} 1 & 0 \\ 2 & -1 \\ 0 & 2 \end{pmatrix}$  and  $C = \begin{pmatrix} 0 & 1 \\ -2 & 5 \end{pmatrix}$ . Which of the following statements

are correct? (i)  $AB + C = \begin{pmatrix} 5 & 5 \\ 5 & 5 \end{pmatrix}$  (ii)  $BC = \begin{pmatrix} 0 & 1 \\ 2 & -3 \\ -4 & 10 \end{pmatrix}$

(iii)  $BA + C = \begin{pmatrix} 2 & 5 \\ 3 & 0 \end{pmatrix}$  (iv)  $(AB)C = \begin{pmatrix} -8 & 20 \\ -8 & 13 \end{pmatrix}$

- (A) (i) and (ii) only (B) (ii) and (iii) only  
 (C) (iii) and (iv) only (D) all of these

### Unit Exercise - 3



- Solve  $\frac{1}{3}(x + y - 5) = y - z = 2x - 11 = 9 - (x + 2z)$
- One hundred and fifty students are admitted to a school. They are distributed over three sections  $A$ ,  $B$  and  $C$ . If 6 students are shifted from section  $A$  to section  $C$ , the sections will have equal number of students. If 4 times of students of section  $C$  exceeds the number of students of section  $A$  by the number of students in section  $B$ , find the number of students in the three sections.



3. In a three-digit number, when the tens and the hundreds digit are interchanged the new number is 54 more than three times the original number. If 198 is added to the number, the digits are reversed. The tens digit exceeds the hundreds digit by twice as that of the tens digit exceeds the unit digit. Find the original number.
4. Find the least common multiple of  $xy(k^2 + 1) + k(x^2 + y^2)$  and  $xy(k^2 - 1) + k(x^2 - y^2)$
5. Find the GCD of the following by division algorithm  
 $2x^4 + 13x^3 + 27x^2 + 23x + 7$ ,  $x^3 + 3x^2 + 3x + 1$ ,  $x^2 + 2x + 1$
6. Reduce the given Rational expressions to its lowest form  
 (i)  $\frac{x^{3a} - 8}{x^{2a} + 2x^a + 4}$       (ii)  $\frac{10x^3 - 25x^2 + 4x - 10}{-4 - 10x^2}$
7. Simplify  $\frac{\frac{1}{p} + \frac{1}{q+r}}{\frac{1}{p} - \frac{1}{q+r}} \times \left(1 + \frac{q^2 + r^2 - p^2}{2qr}\right)$
8. Arul, Madan and Ram working together can clean a store in 6 hours. Working alone, Madan takes twice as long to clean the store as Arul does. Ram needs three times as long as Arul does. How long would it take each if they are working alone?
9. Find the square root of  $289x^4 - 612x^3 + 970x^2 - 684x + 361$ .
10. Solve  $\sqrt{y+1} + \sqrt{2y-5} = 3$
11. A boat takes 1.6 hours longer to go 36 kms up a river than down the river. If the speed of the water current is 4 km per hr, what is the speed of the boat in still water?
12. Is it possible to design a rectangular park of perimeter 320 m and area  $4800 \text{ m}^2$ ? If so find its length and breadth.
13. At  $t$  minutes past 2 pm, the time needed to 3 pm is 3 minutes less than  $\frac{t^2}{4}$ . Find  $t$ .
14. The number of seats in a row is equal to the total number of rows in a hall. The total number of seats in the hall will increase by 375 if the number of rows is doubled and the number of seats in each row is reduced by 5. Find the number of rows in the hall at the beginning.
15. If  $\alpha$  and  $\beta$  are the roots of the polynomial  $f(x) = x^2 - 2x + 3$ , find the polynomial whose roots are (i)  $\alpha + 2$ ,  $\beta + 2$  (ii)  $\frac{\alpha - 1}{\alpha + 1}$ ,  $\frac{\beta - 1}{\beta + 1}$ .
16. If  $-4$  is a root of the equation  $x^2 + px - 4 = 0$  and if the equation  $x^2 + px + q = 0$  has equal roots, find the values of  $p$  and  $q$ .
17. Two farmers Thilagan and Kausigan cultivates three varieties of grains namely rice, wheat and ragi. If the sale (in ₹) of three varieties of grains by both the farmers in the month of April is given by the matrix.

April sale in ₹			
rice	wheat	ragi	
500	1000	1500	Thilagan
2500	1500	500	Kausigan

and the May month sale (in ₹) is exactly twice as that of the April month sale for each variety.

- (i) What is the average sales of the months April and May.  
(ii) If the sales continues to increase in the same way in the successive months, what will be sales in the month of August?
18. If  $\cos \theta \begin{pmatrix} \cos \theta & \sin \theta \\ -\sin \theta & \cos \theta \end{pmatrix} + \sin \theta \begin{pmatrix} x & -\cos \theta \\ \cos \theta & x \end{pmatrix} = I_2$ , find  $x$ .
19. Given  $A = \begin{pmatrix} p & 0 \\ 0 & 2 \end{pmatrix}$ ,  $B = \begin{pmatrix} 0 & -q \\ 1 & 0 \end{pmatrix}$ ,  $C = \begin{pmatrix} 2 & -2 \\ 2 & 2 \end{pmatrix}$  and if  $BA = C^2$ , find  $p$  and  $q$ .
20.  $A = \begin{pmatrix} 3 & 0 \\ 4 & 5 \end{pmatrix}$ ,  $B = \begin{pmatrix} 6 & 3 \\ 8 & 5 \end{pmatrix}$ ,  $C = \begin{pmatrix} 3 & 6 \\ 1 & 1 \end{pmatrix}$  find the matrix  $D$ , such that  $CD - AB = 0$

### Points to Remember



- A system of linear equations in three variables will be according to one of the following cases.  
(i) Unique solution (ii) Infinitely many solutions (iii) No solution
- The least common multiple of two or more algebraic expressions is the expression of lowest degree (or power) such that the expressions exactly divides it.
- A polynomial of degree two in variable  $x$  is called a quadratic polynomial in  $x$ . Every quadratic polynomial can have atmost two zeroes. Also the zeroes of a quadratic polynomial intersects the  $x$ -axis.
- The roots of the quadratic equation  $ax^2 + bx + c = 0$ , ( $a \neq 0$ ) are given by  $\frac{-b \pm \sqrt{b^2 - 4ac}}{2a}$ .
- For a quadratic equation  $ax^2 + bx + c = 0$ ,  $a \neq 0$   
Sum of the roots  $\alpha + \beta = \frac{-b}{a} = \frac{-\text{Co-efficient of } x}{\text{Co-efficient of } x^2}$   
Product of the roots  $\alpha\beta = \frac{c}{a} = \frac{\text{Constant term}}{\text{Co-efficient of } x^2}$
- If the roots of a quadratic equation are  $\alpha$  and  $\beta$ , then the equation is given by  $x^2 - (\alpha + \beta)x + \alpha\beta = 0$ .

- The value of the discriminant ( $\Delta = b^2 - 4ac$ ) decides the nature of roots as follows
  - (i) When  $\Delta > 0$ , the roots are real and unequal.
  - (ii) When  $\Delta = 0$ , the roots are real and equal.
  - (iii) When  $\Delta < 0$ , there are no real roots.

- Solving quadratic equation graphically.

- A matrix is a rectangular array of elements arranged in rows and columns.

- Order of a matrix

If a matrix  $A$  has  $m$  number of rows and  $n$  number of columns, then the order of the matrix  $A$  is (Number of rows)  $\times$  (Number of columns) that is,  $m \times n$ . We read  $m \times n$  as  $m$  cross  $n$  or  $m$  by  $n$ . It may be noted that  $m \times n$  is not a product of  $m$  and  $n$ .

- Types of matrices

- (i) A matrix is said to be a **row matrix** if it has only one row and any number of columns. A **row matrix** is also called as a **row vector**.
- (ii) A matrix is said to be a **column matrix** if it has only one column and any number of rows. It is also called as a **column vector**.
- (iii) A matrix in which the **number of rows** is **equal to** the **number of columns** is called a **square matrix**.
- (iv) A matrix is said to be a **zero matrix** or **null matrix** if all its elements are zero.
- (v) If  $A$  is a matrix, the matrix obtained by interchanging the rows and columns of  $A$  is called its transpose and is denoted by  $A^T$ .
- (vi) A square matrix, all of whose elements, except those in the leading diagonal are zero is called a **diagonal matrix**.
- (vii) A diagonal matrix in which all the leading diagonal elements are same is called a **scalar matrix**.
- (viii) A square matrix in which elements in the leading diagonal are all "1" and rest are all zero is called an **identity matrix** (or) **unit matrix**.
- (ix) A square matrix in which all the entries above the leading diagonal are zero is called a **lower triangular matrix**.  
If all the entries below the leading diagonal are zero, then it is called an **upper triangular matrix**.
- (x) Two matrices  $A$  and  $B$  are said to be equal if and only if they have the same order and each element of matrix  $A$  is equal to the corresponding element of matrix  $B$ . That is,  $a_{ij} = b_{ij}$  for all  $i, j$ .

- The negative of a matrix  $A_{m \times n}$  denoted by  $-A_{m \times n}$  is the matrix formed by replacing each element in the matrix  $A_{m \times n}$  with its additive inverse.

- **Addition and subtraction of matrices**

Two matrices can be added or subtracted if they have the same order. To add or subtract two matrices, simply add or subtract the corresponding elements.

- **Multiplication of matrix by a scalar**

We can multiply the elements of the given matrix  $A$  by a non-zero number  $k$  to obtain a new matrix  $kA$  whose elements are multiplied by  $k$ . The matrix  $kA$  is called scalar multiplication of  $A$ .

Thus if  $A = (a_{ij})_{m \times n}$  then ,  $kA = (ka_{ij})_{m \times n}$  for all  $i = 1, 2, \dots, m$  and for all  $j = 1, 2, \dots, n$ .

### ICT CORNER



#### ICT 3.1

**Step 1:** Open the Browser type the URL Link given below (or) Scan the QR Code. Chapter named “Algebra” will open. Select the work sheet “Simultaneous equations”

**Step 2:** In the given worksheet you can see three linear equations and you can change the equations by typing new values for a, b and c for each equation. You can move the 3-D graph to observe. Observe the nature of solutions by changing the equations.

Step 1

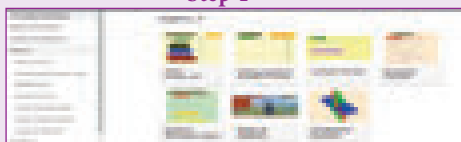

Step 2



Expected results

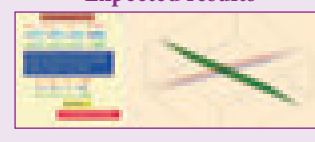

#### ICT 3.2

**Step - 1:** Open the Browser type the URL Link given below (or) Scan the QR Code. GeoGebra work book named “ALGEBRA” will open. Click on the worksheet named “Nature of Quadratic Equation”.

**Step - 2:** In the given worksheet you can change the co-efficient by moving the sliders given. Click on “New position” and move the sliders to fix the boundary for throwing the shell. Then click on “Get Ball” and click “fire” to hit the target. Here you can learn what happen to the curve when each co-efficient is changed.

Step 1

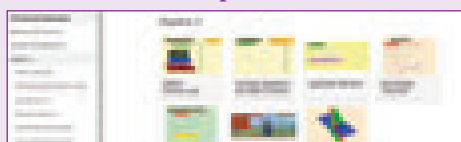

Step 2

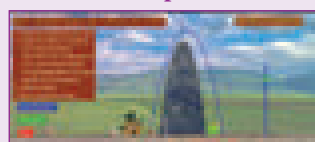

Expected results

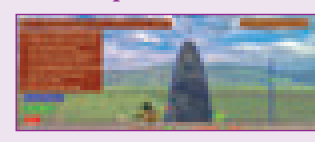

You can repeat the same steps for other activities

<https://www.geogebra.org/m/jfr2zzgy#chapter/356193>  
or Scan the QR Code.



# GEOMETRY

“The knowledge of which geometry aims is the knowledge of eternal”  
– Plato

# 4

Omar Khayyam was a Persian mathematician, astronomer and poet. As a poet, his classic work Rubaiyat attained world fame.

Khayyam’s work is an effort to unify Algebra and Geometry. Khayyam’s work can be considered the first systematic study and the first exact method of solving cubic equations. He accomplished this task using Geometry. His efforts in trying to generalize the principles of Geometry provided by Euclid, inspired many European mathematicians to the eventual discovery of non-Euclidean Geometry. Khayyam was a perfect example of being a notable scientist and a great poet, an achievement which many do not possess.



Omar Khayyam  
(18.5.1048 – 4.12.1131)



## Learning Outcomes

- To recall congruent triangles and understand the definition of similar triangles.
- To understand the properties and construction of similar triangles and apply them to solve problems.
- To prove basic proportionality theorem, angle bisector theorem and study their applications and study the construction of triangles under given conditions.
- To prove Pythagoras theorem and study its applications.
- To understand the concept of tangent to a circle and study construction of tangent to circle.
- To understand and apply concurrency theorems.

## 4.1 Introduction

The study of Geometry is concerned with knowing properties of various shapes and structures. Arithmetic and Geometry were considered to be the two oldest branches of mathematics. Greeks held Geometry in high esteem and used its properties to discuss various scientific principles which otherwise would have been impossible. Eratosthenes used the similarity of circle to determine the circumference of the Earth, distances of the moon and the sun from the Earth, to a remarkable accuracy. Apart from these achievements, similarity is used to find width of rivers, height of trees and much more.



In this chapter, we will be discussing the concepts mainly as continuation of previous classes and discuss most important concepts like Similar Triangles, Basic Proportionality Theorem, Angle Bisector Theorem, the most prominent and widely acclaimed Pythagoras Theorem and much more. Ceva's Theorem and Menelaus Theorem is introduced for the first time. These two new theorems generalize all concurrent theorems that we know. Overall, the study of Geometry will create interest in the deep understanding of objects around us.

Geometry plays vital role in the field of Science, Engineering and Architecture. We see many Geometrical patterns in nature. We are familiar with triangles and many of their properties from earlier classes.

## 4.2 Similarity

Two figures are said to be similar if every aspect of one figure is proportional to other figure. For example:



Fig. 4.1

The above houses look the same but different in size. Both the mobile phones are the same but they vary in their sizes. Therefore, mathematically we say that two objects are similar if they are of same shape but not necessarily they need to have the same size. The ratio of the corresponding measurements of two similar objects must be proportional.

Here is a box of geometrical shapes. Collect the similar objects and list out.

In this chapter, we will be discussing specifically the use of similar triangles which is of utmost importance where if it is beyond our reach to physically measure the distance and height with simple measuring instruments. The concept of similarity is widely used in the fields of engineering, architecture and construction.



Fig. 4.2

Here are few applications of similarity

- (i) By analyzing the shadows that make triangles, we can determine the actual height of the objects.
- (ii) Used in aerial photography to determine the distance from sky to a particular location on the ground.
- (iii) Used in Architecture to aid in design of their work.

### 4.2.1 Similar triangles

In class IX, we have studied congruent triangles. We can say that two geometrical figures are congruent, if they have same size and shape. But, here we shall study about geometrical figures which have same shape but proportional sizes. These figures are called "similar".

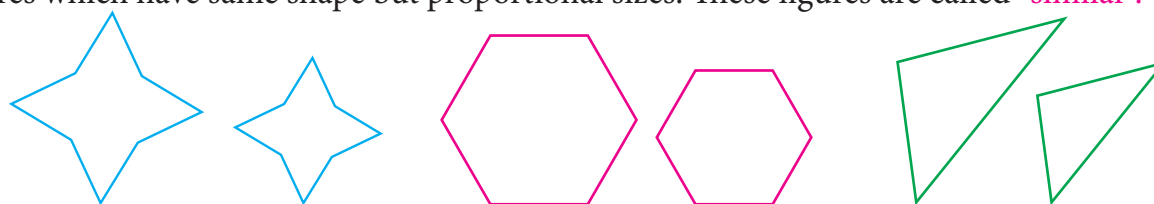

Fig. 4.3



### Congruency and similarity of triangles

Congruency is a particular case of similarity. In both the cases, three angles of one triangle are equal to the three corresponding angles of the other triangle. But in congruent triangles, the corresponding sides are equal. While in similar triangles, the corresponding sides are proportional.

**Note**

The triangles  $ABC$  and  $PQR$  are similar can be written as  $\Delta ABC \sim \Delta PQR$

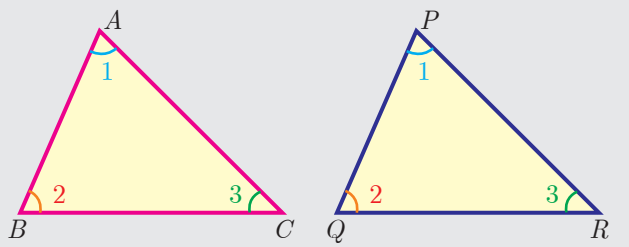
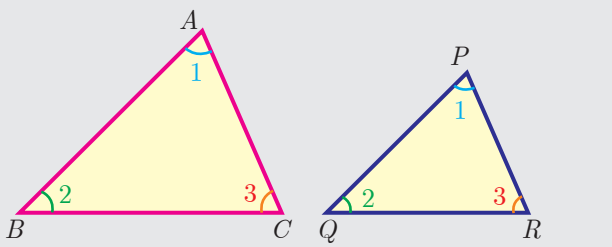
Congruent triangles	Similar triangles
 <p>Fig. 4.4</p>	 <p>Fig. 4.5</p>
$\Delta ABC \cong \Delta PQR$ $\angle A = \angle P, \angle B = \angle Q, \angle C = \angle R.$ $AB = PQ, BC = QR, CA = RP$ $\frac{AB}{PQ} = \frac{BC}{QR} = \frac{CA}{RP} = 1$ Same shape and same size.	$\Delta ABC \sim \Delta PQR$ $\angle A = \angle P, \angle B = \angle Q, \angle C = \angle R$ $AB \neq PQ, BC \neq QR, CA \neq RP$ but $\frac{AB}{PQ} = \frac{BC}{QR} = \frac{CA}{RP} > 1 \text{ or } < 1$ Same shape but not same size.

### Thinking Corner

1. Are square and a rhombus similar or congruent. Discuss.
2. Are a rectangle and a parallelogram similar. Discuss.

### 4.2.2 Criteria of Similarity

The following criteria are sufficient to prove that two triangles are similar.

#### AA Criterion of similarity

If two angles of one triangle are respectively equal to two angles of another triangle, then the two triangles are similar, because the third angle in both triangles must be equal. Therefore, **AA similarity criterion** is same as the **AAA similarity criterion**.

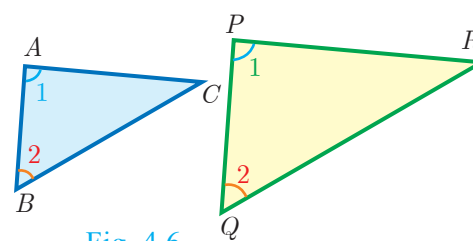

So if  $\angle A = \angle P = 1$  and  $\angle B = \angle Q = 2$  then  $\Delta ABC \sim \Delta PQR$ .

#### SAS Criterion of similarity

If one angle of a triangle is equal to one angle of another triangle and if the sides including them are proportional then the two triangles are similar.

Thus if  $\angle A = \angle P = 1$  and

$$\frac{AB}{PQ} = \frac{AC}{PR} \text{ then } \Delta ABC \sim \Delta PQR$$

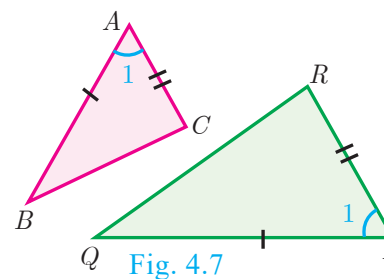

### SSS Criterion of similarity

If three sides of a triangle are proportional to the three corresponding sides of another triangle, then the two triangles are similar.

So if,  $\frac{AB}{PQ} = \frac{AC}{PR} = \frac{BC}{QR}$  then  $\Delta ABC \sim \Delta PQR$

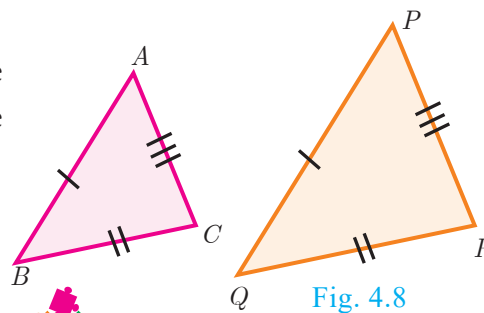

Fig. 4.8

### Thinking Corner

Are any two right angled triangles similar? If so why?

### Some useful results on similar triangles

1. A perpendicular line drawn from the vertex of a right angled triangle divides the triangle into two triangles similar to each other and also to original triangle.

$$\Delta ADB \sim \Delta BDC, \Delta ABC \sim \Delta ADB, \Delta ABC \sim \Delta BDC$$

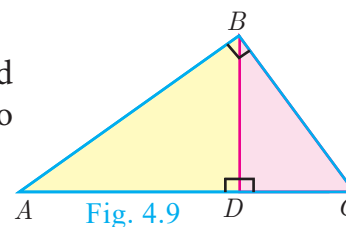

Fig. 4.9

2. If two triangles are similar, then the ratio of the corresponding sides are equal to the ratio of their corresponding altitudes.

i.e. if  $\Delta ABC \sim \Delta PQR$  then

$$\frac{AB}{PQ} = \frac{BC}{QR} = \frac{CA}{RP} = \frac{AD}{PS} = \frac{BE}{QT} = \frac{CF}{RU}$$

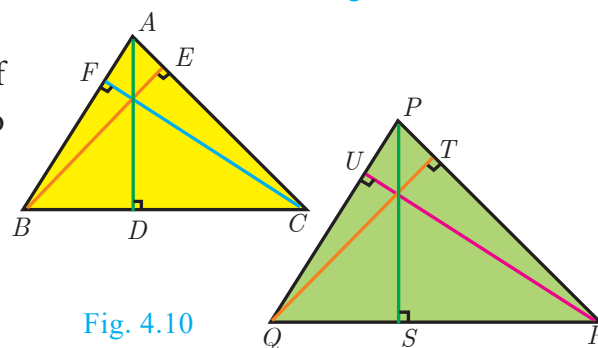

Fig. 4.10

3. If two triangles are similar, then the ratio of the corresponding sides are equal to the ratio of the corresponding perimeters.

$\Delta ABC \sim \Delta DEF$  then

$$\frac{AB}{DE} = \frac{BC}{EF} = \frac{CA}{FD} = \frac{AB + BC + CA}{DE + EF + FD}$$

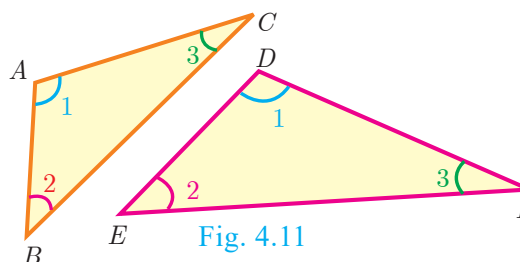

Fig. 4.11

4. The ratio of the area of two similar triangles are equal to the ratio of the squares of their corresponding sides.

$$\frac{\text{area}(\Delta ABC)}{\text{area}(\Delta PQR)} = \frac{AB^2}{PQ^2} = \frac{BC^2}{QR^2} = \frac{AC^2}{PR^2}$$

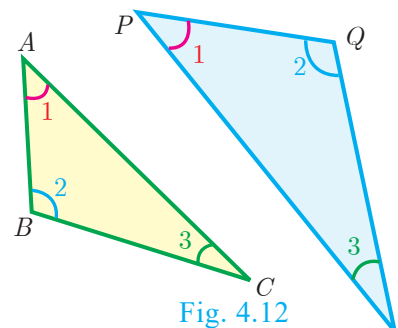

Fig. 4.12

5. If two triangles have common vertex and their bases are on the same straight line, the ratio between their areas is equal to the ratio between the length of their bases.

Here,  $\frac{\text{area}(\Delta ABD)}{\text{area}(\Delta BDC)} = \frac{AD}{DC}$ .

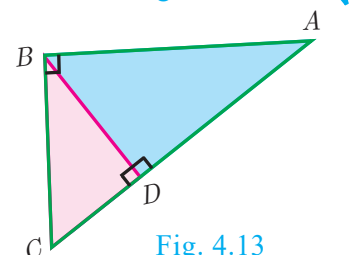

Fig. 4.13

**Definition 1**

Two triangles are said to be similar if their corresponding sides are proportional.

**Definition 2**

The triangles are equiangular if the corresponding angles are equal.

**Illustration** Two triangles,  $\triangle XYZ$  and  $\triangle LMN$  are similar because the corresponding angles are equal.

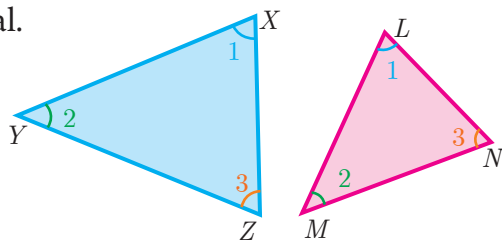

Fig. 4.14

- (i)  $\angle X = \angle L, \angle Y = \angle M, \angle Z = \angle N$  (by angles) (ii)  $\frac{XY}{LM} = \frac{YZ}{MN} = \frac{XZ}{LN}$  (by sides)

Here the vertices  $X, Y, Z$  correspond to the vertices  $L, M, N$  respectively. Thus in symbol  $\triangle XYZ \sim \triangle LMN$

**Example 4.1** Show that  $\triangle PST \sim \triangle PQR$

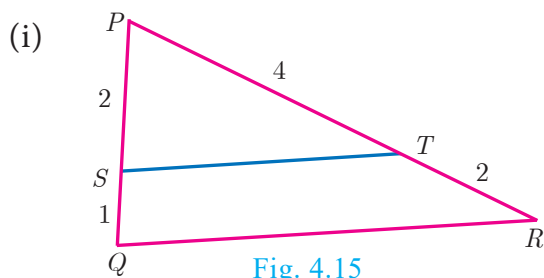

Fig. 4.15

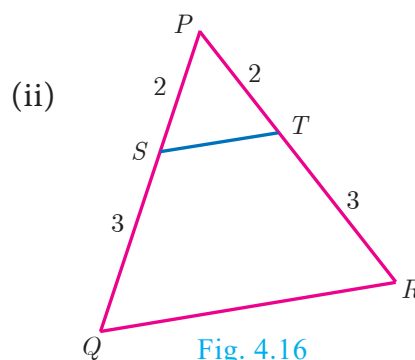

Fig. 4.16

**Solution**

(i) In  $\triangle PST$  and  $\triangle PQR$ ,

$$\frac{PS}{PQ} = \frac{2}{2+1} = \frac{2}{3}, \frac{PT}{PR} = \frac{2}{4+2} = \frac{2}{3}$$

Thus,  $\frac{PS}{PQ} = \frac{PT}{PR}$  and  $\angle P$  is common

Therefore, by SAS similarity,

$$\triangle PST \sim \triangle PQR$$

(ii) In  $\triangle PST$  and  $\triangle PQR$ ,

$$\frac{PS}{PQ} = \frac{2}{2+3} = \frac{2}{5}, \frac{PT}{PR} = \frac{2}{2+3} = \frac{2}{5}$$

Thus,  $\frac{PS}{PQ} = \frac{PT}{PR}$  and  $\angle P$  is common

Therefore, by SAS similarity,

$$\triangle PST \sim \triangle PQR$$

**Example 4.2** Is  $\triangle ABC \sim \triangle PQR$ ?

**Solution** In  $\triangle ABC$  and  $\triangle PQR$ ,

$$\frac{PQ}{AB} = \frac{3}{6} = \frac{1}{2}; \frac{QR}{BC} = \frac{4}{10} = \frac{2}{5}$$

since  $\frac{1}{2} \neq \frac{2}{5}, \frac{PQ}{AB} \neq \frac{QR}{BC}$ .

The corresponding sides are not proportional.

Therefore  $\triangle ABC$  is not similar to  $\triangle PQR$ .

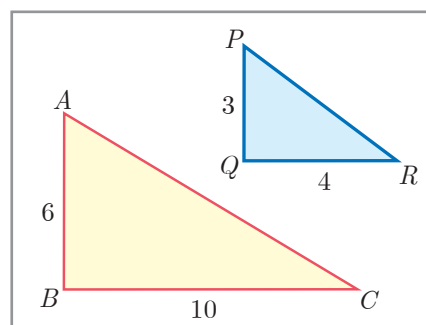

Fig. 4.17

**Note**

If we change exactly one of the four given lengths, then we can make these triangles similar.

**Example 4.3** Observe Fig.4.18 and find  $\angle P$ .

**Solution** In  $\triangle BAC$  and  $\triangle PRQ$ ,  $\frac{AB}{RQ} = \frac{3}{6} = \frac{1}{2}$ ;

$$\frac{BC}{QP} = \frac{6}{12} = \frac{1}{2}; \quad \frac{CA}{PR} = \frac{3\sqrt{3}}{6\sqrt{3}} = \frac{1}{2}$$

Therefore,  $\frac{AB}{RQ} = \frac{BC}{QP} = \frac{CA}{PR}$

By *SSS* similarity, we have  $\triangle BAC \sim \triangle QRP$

$$\angle P = \angle C \text{ (since the corresponding parts of similar triangle)}$$

$$\angle P = \angle C = 180^\circ - (\angle A + \angle B) = 180^\circ - (90^\circ + 60^\circ)$$

$$\angle P = 180^\circ - 150^\circ = 30^\circ$$

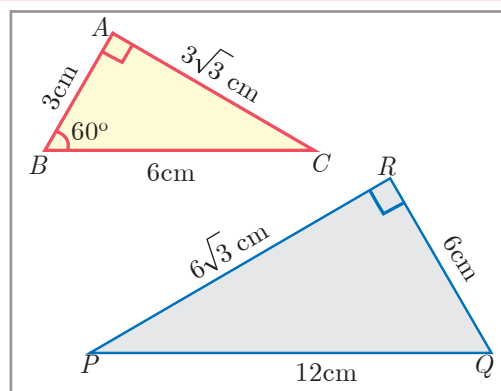

Fig. 4.18

**Example 4.4** A boy of height 90cm is walking away from the base of a lamp post at a speed of 1.2m/sec. If the lamppost is 3.6m above the ground, find the length of his shadow cast after 4 seconds.

**Solution** Given, speed = 1.2 m/s,

$$\text{time} = 4 \text{ seconds}$$

$$\text{distance} = \text{speed} \times \text{time}$$

$$= 1.2 \times 4 = 4.8 \text{ m}$$

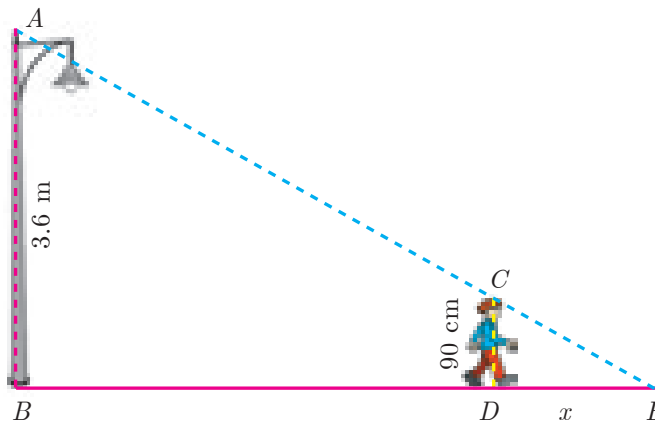

Fig. 4.19

Let  $x$  be the length of the shadow after 4 seconds

Since,  $\triangle ABE \sim \triangle CDE$ ,  $\frac{BE}{DE} = \frac{AB}{CD}$  gives  $\frac{4.8 + x}{x} = \frac{3.6}{0.9} = 4$  (since 90 cm = 0.9 m)

$$4.8 + x = 4x \text{ gives } 3x = 4.8 \text{ so, } x = 1.6 \text{ m}$$

The length of his shadow  $DE = 1.6$  m

**Example 4.5** In Fig.4.20  $\angle A = \angle CED$  prove that  $\triangle CAB \sim \triangle CED$ . Also find the value of  $x$ .

**Solution** In  $\triangle CAB$  and  $\triangle CED$ ,  $\angle C$  is common,  $\angle A = \angle CED$

Therefore,  $\triangle CAB \sim \triangle CED$  (By *AA* similarity)

Hence,  $\frac{CA}{CE} = \frac{AB}{DE} = \frac{CB}{CD}$

$$\frac{AB}{DE} = \frac{CB}{CD} \text{ gives } \frac{9}{x} = \frac{10 + 2}{8} \text{ so, } x = \frac{8 \times 9}{12} = 6 \text{ cm.}$$

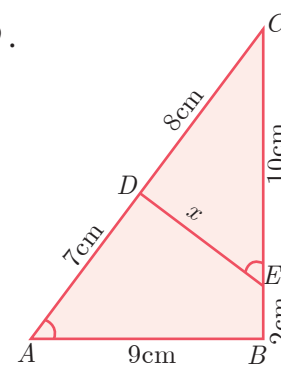

Fig. 4.20

**Example 4.6** In Fig.4.21,  $QA$  and  $PB$  are perpendiculars to  $AB$ . If  $AO = 10$  cm,  $BO=6$  cm and  $PB=9$  cm. Find  $AQ$ .

**Solution** In  $\triangle AOQ$  and  $\triangle BOP$ ,  $\angle OAQ = \angle OBP = 90^\circ$

$\angle AOQ = \angle BOP$  (Vertically opposite angles)

Therefore, by AA Criterion of similarity,

$\triangle AOQ \sim \triangle BOP$

$$\frac{AO}{BO} = \frac{OQ}{OP} = \frac{AQ}{BP}$$

$$\frac{10}{6} = \frac{AQ}{9} \Rightarrow AQ = \frac{10 \times 9}{6} = 15 \text{ cm}$$

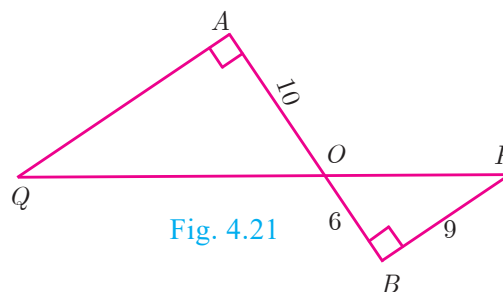

Fig. 4.21

**Example 4.7** The perimeters of two similar triangles  $ABC$  and  $PQR$  are respectively 36 cm and 24 cm. If  $PQ = 10$  cm, find  $AB$ .

**Solution** The ratio of the corresponding sides of similar triangles is same as the ratio of their perimeters.

Since  $\triangle ABC \sim \triangle PQR$ ,

$$\frac{AB}{PQ} = \frac{BC}{QR} = \frac{AC}{PR} = \frac{36}{24}$$

$$\frac{AB}{PQ} = \frac{36}{24} \Rightarrow \frac{AB}{10} = \frac{36}{24}$$

$$AB = \frac{36 \times 10}{24} = 15 \text{ cm}$$

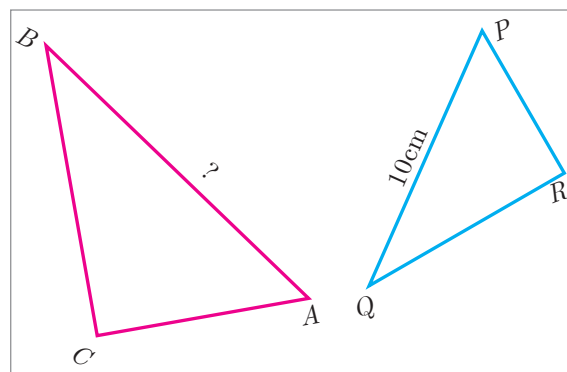

Fig. 4.22

**Example 4.8** If  $\triangle ABC$  is similar to  $\triangle DEF$  such that  $BC=3$  cm,  $EF=4$  cm and area of  $\triangle ABC = 54 \text{ cm}^2$ . Find the area of  $\triangle DEF$ .

**Solution** Since the ratio of area of two similar triangles is equal to the ratio of the squares of any two corresponding sides, we have

$$\frac{\text{Area}(\triangle ABC)}{\text{Area}(\triangle DEF)} = \frac{BC^2}{EF^2} \Rightarrow \frac{54}{\text{Area}(\triangle DEF)} = \frac{3^2}{4^2}$$

$$\text{Area}(\triangle DEF) = \frac{16 \times 54}{9} = 96 \text{ cm}^2$$

**Example 4.9** Two poles of height ' $a$ ' metres and ' $b$ ' metres are ' $p$ ' metres apart. Prove that the height of the point of intersection of the lines joining the top of each pole to the foot of the opposite pole is given by  $\frac{ab}{a+b}$  metres.

**Solution** Let  $AB$  and  $CD$  be two poles of height ' $a$ ' metres and ' $b$ ' metres respectively such that the poles are ' $p$ ' metres apart. That is  $AC=p$  metres. Suppose the lines  $AD$  and  $BC$  meet at  $O$ , such that  $OL=h$  metres

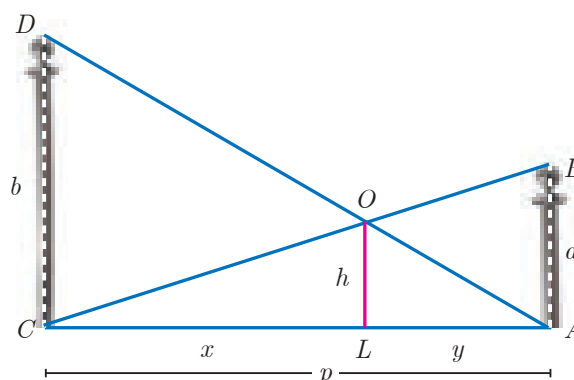

Fig. 4.23



Let  $CL = x$  and  $LA = y$ .

Then,  $x + y = p$

In  $\triangle ABC$  and  $\triangle LOC$ , we have

$$\angle CAB = \angle CLO \text{ [each equal to } 90^\circ \text{]}$$

$$\angle C = \angle C \text{ [C is common]}$$

$\triangle CAB \sim \triangle CLO$  [By AA similarity]

$$\frac{CA}{CL} = \frac{AB}{LO} \Rightarrow \frac{p}{x} = \frac{a}{h}$$

$$\text{so, } x = \frac{ph}{a} \quad \dots(1)$$

In  $\triangle ALO$  and  $\triangle ACD$ , we have

$$\angle ALO = \angle ACD \text{ [each equal to } 90^\circ \text{]}$$

$$\angle A = \angle A \text{ [A is common]}$$

$\triangle ALO \sim \triangle ACD$  [by AA similarity]

$$\frac{AL}{AC} = \frac{OL}{DC} \Rightarrow \frac{y}{p} = \frac{h}{b} \text{ we get, } y = \frac{ph}{b} \quad \dots(2)$$

$$(1)+(2) \Rightarrow x + y = \frac{ph}{a} + \frac{ph}{b}$$

$$p = ph \left( \frac{1}{a} + \frac{1}{b} \right) \quad (\text{Since } x + y = p)$$

$$1 = h \left( \frac{a+b}{ab} \right)$$

$$\text{Therefore, } h = \frac{ab}{a+b}$$

Hence, the height of the intersection of the lines joining the top of each pole to the foot of the opposite pole is  $\frac{ab}{a+b}$  metres.



### Progress Check

- All circles are \_\_\_\_\_ (congruent/similar).
- All squares are \_\_\_\_\_ (similar/congruent).
- Two triangles are similar, if their corresponding angles are \_\_\_\_\_ and their corresponding sides are \_\_\_\_\_.
- (a) All similar triangles are congruent – True/False  
(b) All congruent triangles are similar – True/False.
- Give two different examples of pair of non-similar figures?



### Activity 1

Let us try to construct a line segment of length  $\sqrt{2}$ .

For this, we consider the following steps.

**Step1:** Take a line segment of length 3 units. Call it as AB.

**Step2:** Take a point C on AB such that AC=2, CB=1.

**Step3:** Draw a semi-circle with AB as diameter as shown in the diagram

**Step4:** Take a point 'P' on the semi-circle such that CP is perpendicular to AB.

**Step5:** Join P to A and B. We will get two right triangles ACP and BCP.

**Step6:** Verify that the triangles ACP and BCP are similar.

**Step7:** Let CP = h be the common altitude. Using similarity, find h.

**Step8:** What do you get upon finding h?

Repeating the same process, can you construct a line segment of lengths  $\sqrt{3}$ ,  $\sqrt{5}$ ,  $\sqrt{8}$ .

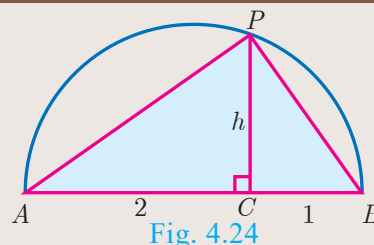

### 4.2.3 Construction of similar triangles

So far we have discussed the theoretical approach of similar triangles and their properties. Now we shall discuss the geometrical construction of a triangle similar to a given triangle whose sides are in a given ratio with the corresponding sides of the given triangle.

This construction includes two different cases. In one, the triangle to be constructed is smaller and in the other it is larger than the given triangle. So, we use the following term called “scale factor” which measures the ratio of the sides of the triangle to be constructed with the corresponding sides of the given triangle. Let us take the following examples involving the two cases:

**Example 4.10** Construct a triangle similar to a given triangle  $PQR$  with its sides equal to  $\frac{3}{5}$  of the corresponding sides of the triangle  $PQR$  (scale factor  $\frac{3}{5} < 1$ )

**Solution** Given a triangle  $PQR$  we are required to construct another triangle whose sides are  $\frac{3}{5}$  of the corresponding sides of the triangle  $PQR$ .

#### Steps of construction

1. Construct a  $\triangle PQR$  with any measurement.
2. Draw a ray  $QX$  making an acute angle with  $QR$  on the side opposite to vertex  $P$ .
3. Locate 5 (the greater of 3 and 5 in  $\frac{3}{5}$ ) points.  
 $Q_1, Q_2, Q_3, Q_4$  and  $Q_5$  on  $QX$  so that  
 $QQ_1 = Q_1Q_2 = Q_2Q_3 = Q_3Q_4 = Q_4Q_5$
4. Join  $Q_5R$  and draw a line through  $Q_3$  (the third point, 3 being smaller of 3 and 5 in  $\frac{3}{5}$ ) parallel to  $Q_5R$  to intersect  $QR$  at  $R'$ .
5. Draw line through  $R'$  parallel to the line  $RP$  to intersect  $QP$  at  $P'$ .

Then,  $\triangle P'QR'$  is the required triangle each of whose sides is three-fifths of the corresponding sides of  $\triangle PQR$ .

**Example 4.11** Construct a triangle similar to a given triangle  $PQR$  with its sides equal to  $\frac{7}{4}$  of the corresponding sides of the triangle  $PQR$  (scale factor  $\frac{7}{4} > 1$ )

**Solution** Given a triangle  $PQR$ , we are required to construct another triangle whose sides are  $\frac{7}{4}$  of the corresponding sides of the triangle  $PQR$ .

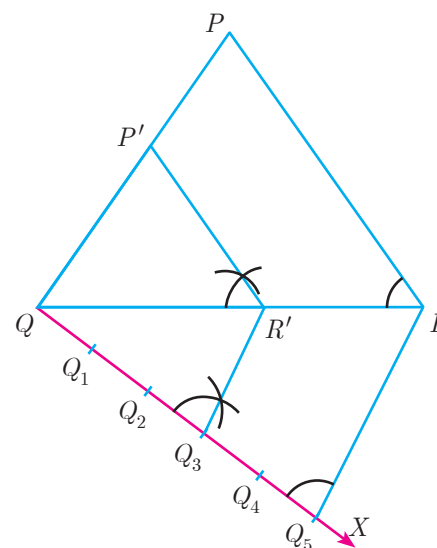
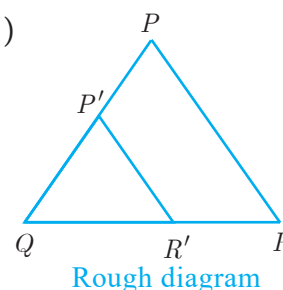
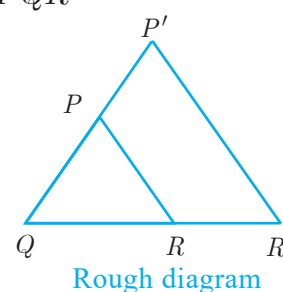

Fig. 4.25



**Steps of construction**

1. Construct a  $\Delta PQR$  with any measurement.
  2. Draw a ray  $QX$  making an acute angle with  $QR$  on the side opposite to vertex  $P$ .
  3. Locate 7 points (the greater of 7 and 4 in  $\frac{7}{4}$ )  $Q_1, Q_2, Q_3, Q_4, Q_5, Q_6$  and  $Q_7$  on  $QX$  so that  $QQ_1 = Q_1Q_2 = Q_2Q_3 = Q_3Q_4 = Q_4Q_5 = Q_5Q_6 = Q_6Q_7$
  4. Join  $Q_4$  (the 4th point, 4 being smaller of 4 and 7 in  $\frac{7}{4}$ ) to  $R$  and draw a line through  $Q_7$  parallel to  $Q_4R$ , intersecting the extended line segment  $QR$  at  $R'$ .
  5. Draw a line through  $R'$  parallel to  $RP$  intersecting the extended line segment  $QP$  at  $P'$
- Then  $\Delta P'QR'$  is the required triangle each of whose sides is seven-fourths of the corresponding sides of  $\Delta PQR$ .

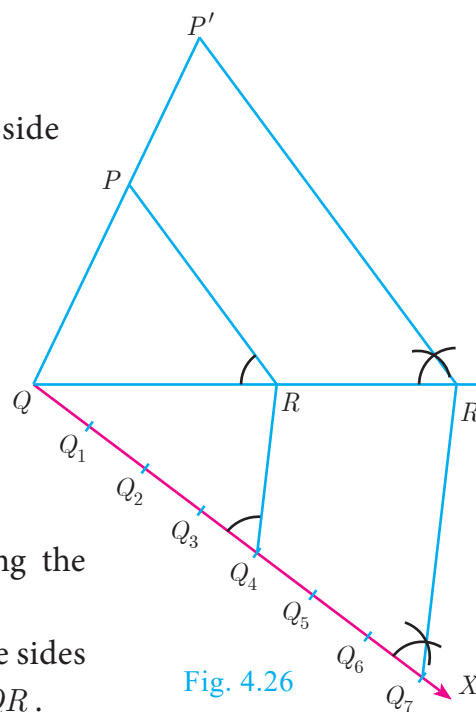
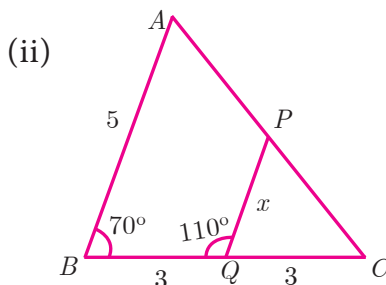
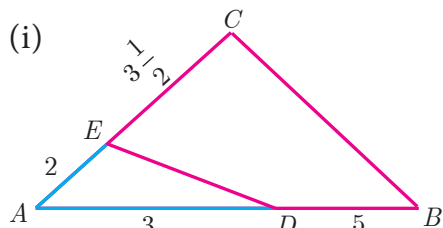

Fig. 4.26



**Exercise 4.1**

1. Check whether the which triangles are similar and find the value of  $x$ .



2. A girl looks the reflection of the top of the lamp post on the mirror which is 6.6 m away from the foot of the lamppost. The girl whose height is 1.25 m is standing 2.5 m away from the mirror. Assuming the mirror is placed on the ground facing the sky and the girl, mirror and the lamppost are in a same line, find the height of the lamp post.
3. A vertical stick of length 6 m casts a shadow 400 cm long on the ground and at the same time a tower casts a shadow 28 m long. Using similarity, find the height of the tower.
4. Two triangles  $QPR$  and  $QSR$ , right angled at  $P$  and  $S$  respectively are drawn on the same base  $QR$  and on the same side of  $QR$ . If  $PR$  and  $SQ$  intersect at  $T$ , prove that  $PT \times TR = ST \times TQ$ .
5. In the adjacent figure,  $\Delta ABC$  is right angled at  $C$  and  $DE \perp AB$ . Prove that  $\Delta ABC \sim \Delta ADE$  and hence find the lengths of  $AE$  and  $DE$ .
6. In the adjacent figure,  $\Delta ACB \sim \Delta APQ$ . If  $BC = 8$  cm,  $PQ = 4$  cm,  $BA = 6.5$  cm and  $AP = 2.8$  cm, find  $CA$  and  $AQ$ .

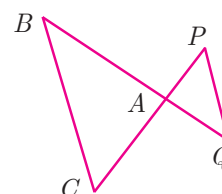
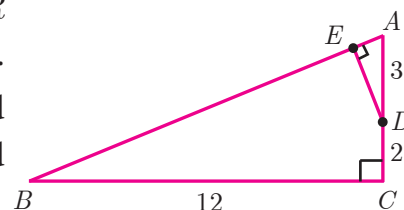





7. If figure  $OPRQ$  is a square and  $\angle MLN = 90^\circ$ . Prove that

- (i)  $\triangle LOP \sim \triangle QMO$  (ii)  $\triangle LOP \sim \triangle RPN$  (iii)  $\triangle QMO \sim \triangle RPN$  (iv)  $QR^2 = MQ \times RN$

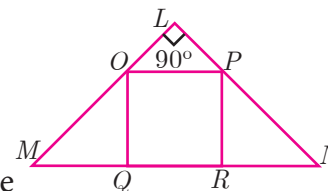

8. If  $\triangle ABC \sim \triangle DEF$  such that area of  $\triangle ABC$  is  $9\text{cm}^2$  and the area of  $\triangle DEF$  is  $16\text{cm}^2$  and  $BC = 2.1$  cm. Find the length of  $EF$ .

9. Two vertical poles of heights 6 m and 3 m are erected above a horizontal ground  $AC$ . Find the value of  $y$ .

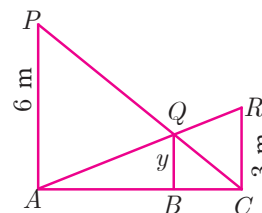

10. Construct a triangle similar to a given triangle  $PQR$  with its sides equal to  $\frac{2}{3}$  of the corresponding sides of the triangle  $PQR$  (scale factor  $\frac{2}{3} < 1$ ).
11. Construct a triangle similar to a given triangle  $LMN$  with its sides equal to  $\frac{4}{5}$  of the corresponding sides of the triangle  $LMN$  (scale factor  $\frac{4}{5} < 1$ ).
12. Construct a triangle similar to a given triangle  $ABC$  with its sides equal to  $\frac{6}{5}$  of the corresponding sides of the triangle  $ABC$  (scale factor  $\frac{6}{5} > 1$ ).
13. Construct a triangle similar to a given triangle  $PQR$  with its sides equal to  $\frac{7}{3}$  of the corresponding sides of the triangle  $PQR$  (scale factor  $\frac{7}{3} > 1$ ).

### 4.3 Thales Theorem and Angle Bisector Theorem

#### 4.3.1 Introduction

Thales, (640 - 540 BC (BCE)) the most famous Greek mathematician and philosopher lived around seventh century BC (BCE). He possessed knowledge to the extent that he became the first of seven sages of Greece. Thales was the first man to announce that any idea that emerged should be tested scientifically and only then it can be accepted. In this aspect, he did great investigations in mathematics and astronomy and discovered many concepts. He was credited for providing first proof in mathematics, which today is called by the name “Basic Proportionality Theorem”. It is also called “Thales Theorem” named after its discoverer.

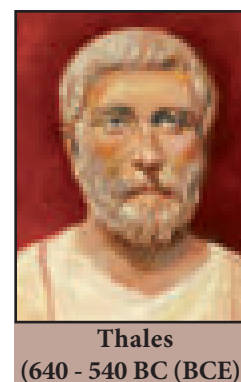

The discovery of the Thales theorem itself is a very interesting story. When Thales travelled to Egypt, he was challenged by Egyptians to determine the height of one of several magnificent pyramids that they had constructed. Thales accepted the challenge and used similarity of triangles to determine the same successfully, another triumphant application of Geometry. Since  $X_0$ ,  $X_1$  and  $H_0$  are known, we can determine the height  $H_1$  of the pyramid.

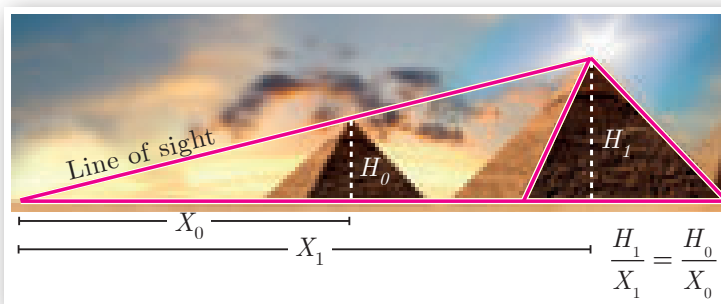

Fig. 4.27

To understand the basic proportionality theorem or Thales theorem, let us do the following activity.



**Activity 2**

Take any ruled paper and draw a triangle  $ABC$  with its base on one of the lines. Several parallel lines will cut the triangle  $ABC$ .

Select any one line among them and name the points where it meets the sides  $AB$  and  $AC$  as  $P$  and  $Q$ .

Can we find the ratio of  $\frac{AP}{PB}$  and  $\frac{AQ}{QC}$ . By measuring  $AP$ ,  $PB$ ,  $AQ$  and  $QC$  through a scale, verify whether the ratios are equal or not? Try for different parallel lines, say  $MN$  and  $RS$ .

Now find the ratios  $\frac{AM}{MB}$ ,  $\frac{AN}{NC}$  and  $\frac{AR}{RB}$ ,  $\frac{AS}{SC}$ .

Check if they are equal? The conclusion will lead us to one of the most important theorem in Geometry, which we will discuss below.

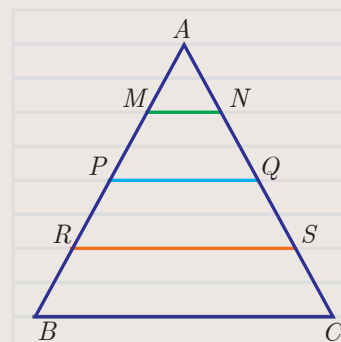

Fig. 4.28

**Theorem 1: Basic Proportionality Theorem (BPT) or Thales theorem**

**Statement**

A straight line drawn parallel to a side of triangle intersecting the other two sides, divides the sides in the same ratio.

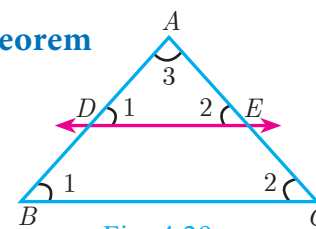

Fig. 4.29

**Proof**

**Given:** In  $\triangle ABC$ ,  $D$  is a point on  $AB$  and  $E$  is a point on  $AC$ .

**To prove:**  $\frac{AD}{DB} = \frac{AE}{EC}$

**Construction:** Draw a line  $DE \parallel BC$

No.	Statement	Reason
1.	$\angle ABC = \angle ADE = \angle 1$	Corresponding angles are equal because $DE \parallel BC$
2.	$\angle ACB = \angle AED = \angle 2$	Corresponding angles are equal because $DE \parallel BC$
3.	$\angle DAE = \angle BAC = \angle 3$	Both triangles have a common angle
	$\triangle ABC \sim \triangle ADE$	By $AAA$ similarity
	$\frac{AB}{AD} = \frac{AC}{AE}$	Corresponding sides are proportional
	$\frac{AD + DB}{AD} = \frac{AE + EC}{AE}$	Split $AB$ and $AC$ using the points $D$ and $E$ .
4.	$1 + \frac{DB}{AD} = 1 + \frac{EC}{AE}$	On simplification
	$\frac{DB}{AD} = \frac{EC}{AE}$	Cancelling 1 on both sides
	$\frac{AD}{DB} = \frac{AE}{EC}$	Taking reciprocals
		Hence proved



### Corollary

If in  $\triangle ABC$ , a straight line  $DE$  parallel to  $BC$ , intersects  $AB$  at  $D$  and  $AC$  at  $E$ , then

(i)  $\frac{AB}{AD} = \frac{AC}{AE}$                       (ii)  $\frac{AB}{DB} = \frac{AC}{EC}$ .

#### Proof

In  $\triangle ABC$ ,  $DE \parallel BC$ ,

Therefore,  $\frac{AD}{DB} = \frac{AE}{EC}$  (by Basic Proportionality Theorem)

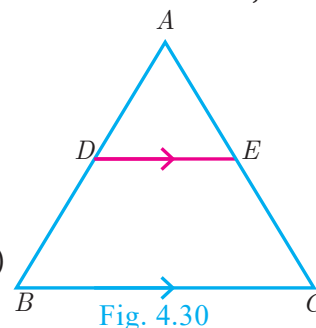

Fig. 4.30

(i) Taking reciprocals, we get  $\frac{DB}{AD} = \frac{EC}{AE}$

Add 1 to both in the sides  $\frac{DB}{AD} + 1 = \frac{EC}{AE} + 1$

$\frac{DB + AD}{AD} = \frac{EC + AE}{AE}$  so,  $\frac{AB}{AD} = \frac{AC}{AE}$

(ii) Add 1 to both the sides

$\frac{AD}{DB} + 1 = \frac{AE}{EC} + 1$

Therefore,  $\frac{AB}{DB} = \frac{AC}{EC}$

Is the converse of Basic Proportionality Theorem also true? To examine let us do the following illustration.

### Illustration

Draw an angle  $XAY$  on your notebook as shown in Fig.4.31 and on ray  $AX$ , mark points  $B_1, B_2, B_3, B_4$  and  $B$  such that  $AB_1 = B_1B_2 = B_2B_3 = B_3B_4 = B_4B = 1$  cm.

Similarly on ray  $AY$ , mark points  $C_1, C_2, C_3, C_4$  and  $C$ , such that

$AC_1 = C_1C_2 = C_2C_3 = C_3C_4 = C_4C = 2$  cm, Join  $B_1C_1$  and  $BC$ .

Observe that  $\frac{AB_1}{B_1B} = \frac{AC_1}{C_1C} = \frac{1}{4}$  and  $B_1C_1 \parallel BC$

Similarly joining  $B_2C_2, B_3C_3$  and  $B_4C_4$  you see that

$\frac{AB_2}{B_2B} = \frac{AC_2}{C_2C} = \frac{2}{3}$  and  $B_2C_2 \parallel BC$

$\frac{AB_3}{B_3B} = \frac{AC_3}{C_3C} = \frac{3}{2}$  and  $B_3C_3 \parallel BC$

$\frac{AB_4}{B_4B} = \frac{AC_4}{C_4C} = \frac{4}{1}$  and  $B_4C_4 \parallel BC$

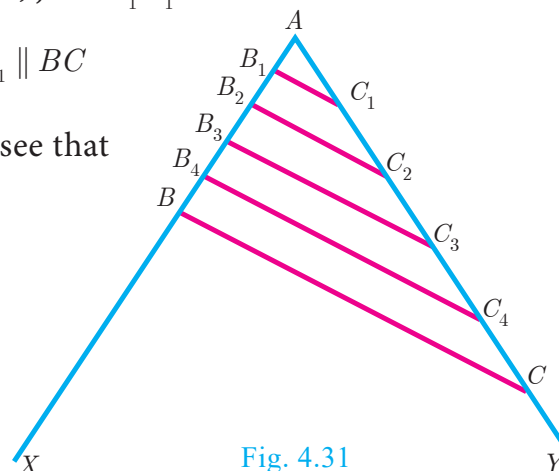

Fig. 4.31

From this we observe that if a line divides two sides of a triangle in the same ratio, then the line is parallel to the third side.

Therefore, we obtain the following theorem called converse of the Thales theorem.

### Theorem 2: Converse of Basic Proportionality Theorem

#### Statement

If a straight line divides any two sides of a triangle in the same ratio, then the line must be parallel to the third side.



**Proof**

**Given** : In  $\triangle ABC$ ,  $\frac{AD}{DB} = \frac{AE}{EC}$

**To prove** :  $DE \parallel BC$

**Construction** : If  $DE$  is not parallel to  $BC$ , draw  $DF \parallel BC$ .

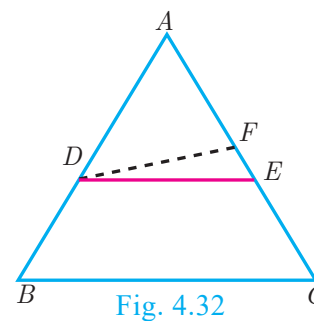

No.	Statement	Reason
1.	$\frac{AD}{DB} = \frac{AE}{EC} \dots(1)$	Given
2.	$\triangle ABC, DF \parallel BC$	Construction
3.	$\frac{AD}{DB} = \frac{AF}{FC} \dots (2)$	Thales theorem
4.	$\frac{AE}{EC} = \frac{AF}{FC}$ $\frac{AE}{EC} + 1 = \frac{AF}{FC} + 1$ $\frac{AE + EC}{EC} = \frac{AF + FC}{FC}$ $\frac{AC}{EC} = \frac{AC}{FC}$ $EC = FC$ <p>Therefore, <math>E = F</math></p> <p>Thus <math>DE \parallel BC</math></p>	<p>From (1) and (2)</p> <p>Adding 1 to both sides</p> <p>Cancelling <math>AC</math> on both sides</p> <p>Our assumption that <math>DE</math> is not parallel to <math>BC</math> is wrong.</p> <p>Hence proved</p>

**Theorem 3: Angle Bisector Theorem**

**Statement**

The internal bisector of an angle of a triangle divides the opposite side internally in the ratio of the corresponding sides containing the angle.

**Proof**

**Given** : In  $\triangle ABC$ ,  $AD$  is the internal bisector

**To prove** :  $\frac{AB}{AC} = \frac{BD}{CD}$

**Construction** : Draw a line through  $C$  parallel to  $AB$ .  
Extend  $AD$  to meet line through  $C$  at  $E$

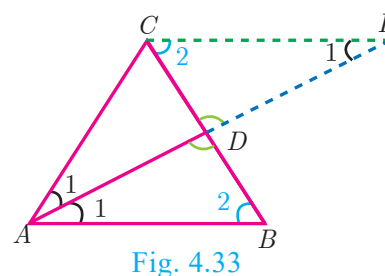

No	Statement	Reason
1.	$\angle AEC = \angle BAE = \angle 1$	Two parallel lines cut by a transversal make alternate angles equal.
2.	$\triangle ACE$ is isosceles $AC = CE \dots (1)$	In $\triangle ACE, \angle CAE = \angle CEA$
3.	$\triangle ABD \sim \triangle ECD$ $\frac{AB}{CE} = \frac{BD}{CD}$	By AA Similarity
4.	$\frac{AB}{AC} = \frac{BD}{CD}$	From (1) $AC = CE$ . Hence proved.



### Activity 3

**Step 1:** Take a chart and cut it like a triangle as shown in Fig.4.34(a).

**Step 2:** Then fold it along the symmetric line  $AD$ . Then  $C$  and  $B$  will be one upon the other.

**Step 3:** Similarly fold it along  $CE$ , then  $B$  and  $A$  will be one upon the other.

**Step 4:** Similarly fold it along  $BF$ , then  $A$  and  $C$  will be one upon the other.

Find  $AB, AC, BD, DC$  using a scale.

Find  $\frac{AB}{AC}, \frac{BD}{DC}$  check if they are equal?

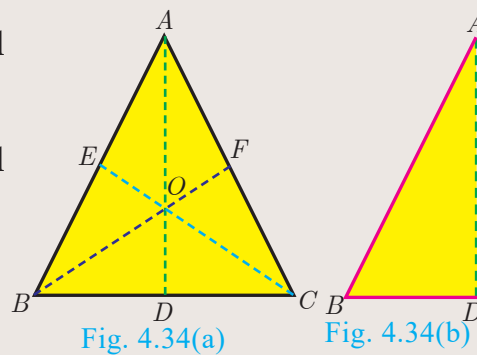

In the three cases, the internal bisector of an angle of a triangle divides the opposite side internally in the ratio of the corresponding sides containing the angle.

What do you conclude from this activity?

### Theorem 4: Converse of Angle Bisector Theorem

#### Statement

If a straight line through one vertex of a triangle divides the opposite side internally in the ratio of the other two sides, then the line bisects the angle internally at the vertex.

#### Proof

**Given** :  $ABC$  is a triangle.  $AD$  divides  $BC$  in the ratio of the sides containing the angles  $\angle A$  to meet  $BC$  at  $D$ .

$$\text{That is } \frac{AB}{AC} = \frac{BD}{DC} \dots (1)$$

**To prove** :  $AD$  bisects  $\angle A$  i.e.  $\angle 1 = \angle 2$

**Construction** : Draw  $CE \parallel DA$ . Extend  $BA$  to meet at  $E$ .

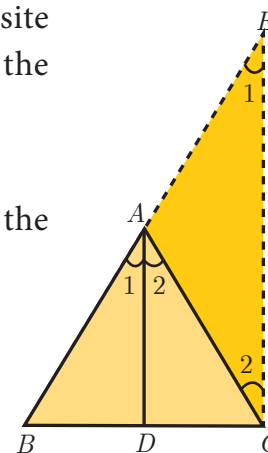

Fig. 4.35

No.	Statement	Reason
1.	Let $\angle BAD = \angle 1$ and $\angle DAC = \angle 2$	Assumption
2.	$\angle BAD = \angle AEC = \angle 1$	Since $DA \parallel CE$ and $AC$ is transversal, corresponding angles are equal
3.	$\angle DAC = \angle ACE = \angle 2$	Since $DA \parallel CE$ and $AC$ is transversal, Alternate angles are equal
4.	$\frac{BA}{AE} = \frac{BD}{DC} \dots (2)$	In $\triangle BCE$ by Thales theorem
5.	$\frac{AB}{AC} = \frac{BD}{DC}$	From (1)
6.	$\frac{AB}{AC} = \frac{BA}{AE}$	From (1) and (2)
7.	$AC = AE \dots (3)$	Cancelling $AB$
8.	$\angle 1 = \angle 2$	$\triangle ACE$ is isosceles by (3)
9.	$AD$ bisects $\angle A$	Since, $\angle 1 = \angle BAD = \angle 2 = \angle DAC$ . Hence proved

**Example 4.12** In  $\triangle ABC$ , if  $DE \parallel BC$ ,  $AD = x$ ,  $DB = x - 2$ ,  $AE = x + 2$  and  $EC = x - 1$  then find the lengths of the sides  $AB$  and  $AC$ .

**Solution** In  $\triangle ABC$  we have  $DE \parallel BC$ .

By Thales theorem, we have  $\frac{AD}{DB} = \frac{AE}{EC}$

$$\frac{x}{x-2} = \frac{x+2}{x-1} \text{ gives } x(x-1) = (x-2)(x+2)$$

$$\text{Hence, } x^2 - x = x^2 - 4 \text{ so, } x = 4$$

When  $x = 4$ ,  $AD = 4$ ,  $DB = x - 2 = 2$ ,  $AE = x + 2 = 6$ ,  $EC = x - 1 = 3$ .

Hence,  $AB = AD + DB = 4 + 2 = 6$ ,  $AC = AE + EC = 6 + 3 = 9$ .

Therefore,  $AB = 6$ ,  $AC = 9$ .

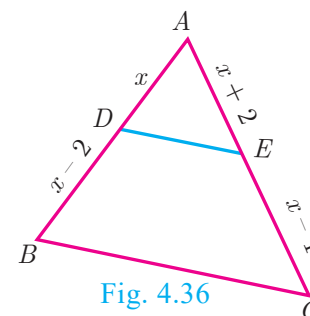

Fig. 4.36

**Example 4.13**  $D$  and  $E$  are respectively the points on the sides  $AB$  and  $AC$  of a  $\triangle ABC$  such that  $AB = 5.6$  cm,  $AD = 1.4$  cm,  $AC = 7.2$  cm and  $AE = 1.8$  cm, show that  $DE \parallel BC$ .

**Solution** We have  $AB = 5.6$  cm,  $AD = 1.4$  cm,  $AC = 7.2$  cm and  $AE = 1.8$  cm.

$$BD = AB - AD = 5.6 - 1.4 = 4.2 \text{ cm}$$

$$\text{and } EC = AC - AE = 7.2 - 1.8 = 5.4 \text{ cm.}$$

$$\frac{AD}{DB} = \frac{1.4}{4.2} = \frac{1}{3} \text{ and } \frac{AE}{EC} = \frac{1.8}{5.4} = \frac{1}{3}$$

$$\frac{AD}{DB} = \frac{AE}{EC}$$

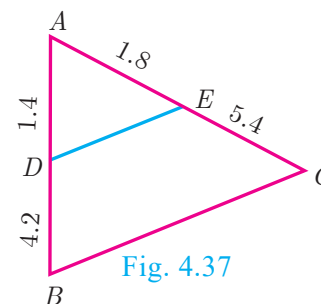

Fig. 4.37

Therefore, by converse of **Basic Proportionality Theorem**, we have  $DE$  is parallel to  $BC$ . Hence proved.

**Example 4.14** In the Fig.4.38,  $DE \parallel AC$  and  $DC \parallel AP$ . Prove that  $\frac{BE}{EC} = \frac{BC}{CP}$ .

**Solution** In  $\triangle BPA$ , we have  $DC \parallel AP$ . By Basic Proportionality Theorem,

$$\text{we have } \frac{BC}{CP} = \frac{BD}{DA} \quad \dots(1)$$

In  $\triangle BCA$ , we have  $DE \parallel AC$ . By Basic Proportionality Theorem, we have,

$$\frac{BE}{EC} = \frac{BD}{DA} \quad \dots(2)$$

From (1) and (2) we get,  $\frac{BE}{EC} = \frac{BC}{CP}$ . Hence proved.

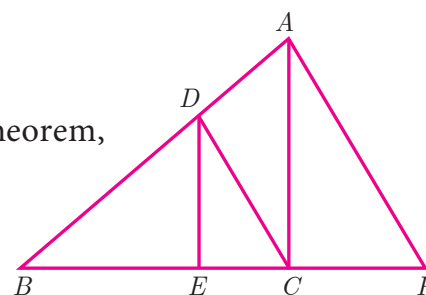

Fig. 4.38

**Example 4.15** In the Fig.4.39,  $AD$  is the bisector of  $\angle A$ . If  $BD = 4$  cm,  $DC = 3$  cm and  $AB = 6$  cm, find  $AC$ .

**Solution** In  $\triangle ABC$ ,  $AD$  is the bisector of  $\angle A$

By Angle Bisector Theorem

$$\frac{BD}{DC} = \frac{AB}{AC}$$

$$\frac{4}{3} = \frac{6}{AC} \text{ gives } 4AC = 18. \text{ Hence, } AC = \frac{9}{2} = 4.5 \text{ cm}$$

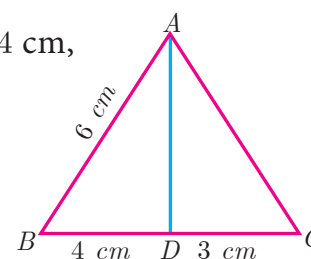

Fig. 4.39

**Example 4.16** In the Fig. 4.40,  $AD$  is the bisector of  $\angle BAC$ , if  $AB = 10$  cm,  $AC = 14$  cm and  $BC = 6$  cm. Find  $BD$  and  $DC$ .

**Solution** Let  $BD = x$  cm, then  $DC = (6-x)$ cm

$AD$  is the bisector of  $\angle A$

By Angle Bisector Theorem

$$\frac{AB}{AC} = \frac{BD}{DC}$$

$$\frac{10}{14} = \frac{x}{6-x} \text{ gives } \frac{5}{7} = \frac{x}{6-x}$$

$$12x = 30 \quad \text{we get, } x = \frac{30}{12} = 2.5 \text{ cm}$$

Therefore,  $BD = 2.5$  cm,  $DC = 6 - x = 6 - 2.5 = 3.5$  cm

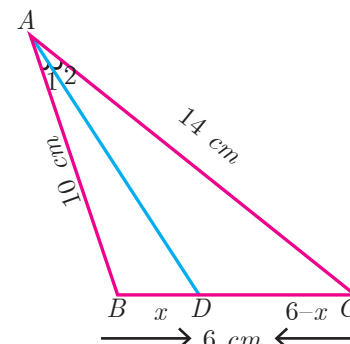

Fig. 4.40



### Progress Check

1. A straight line drawn \_\_\_\_\_ to a side of a triangle divides the other two sides proportionally.
2. Basic Proportionality Theorem is also known as \_\_\_\_\_.

3. Let  $\triangle ABC$  be equilateral. If  $D$  is a point on  $BC$  and  $AD$  is the internal bisector of  $\angle A$ . Using Angle Bisector Theorem,  $\frac{BD}{DC}$  is \_\_\_\_\_.
4. The \_\_\_\_\_ of an angle of a triangle divides the opposite side internally in the ratio of the corresponding sides containing the angle.
5. If the median  $AD$  to the side  $BC$  of a  $\triangle ABC$  is also an angle bisector of  $\angle A$  then  $\frac{AB}{AC}$  is \_\_\_\_\_.

### 4.3.2 Construction of triangle

We have already learnt in previous class how to construct triangles when sides and angles are given.

In this section, let us construct a triangle when the following are given :

- (i) the base, vertical angle and the median on the base
- (ii) the base, vertical angle and the altitude on the base
- (iii) the base, vertical angle and the point on the base where the bisector of the vertical angle meets the base.

First, we consider the following construction,

#### Construction of a segment of a circle on a given line segment containing an angle $\theta$

##### Construction

- Step 1:** Draw a line segment  $\overline{AB}$ .
- Step 2:** At  $A$ , take  $\angle BAE = \theta$  Draw  $AE$ .
- Step 3:** Draw,  $AF \perp AE$ .
- Step 4:** Draw the perpendicular bisector of  $AB$  meeting  $AF$  at  $O$ .
- Step 5:** With  $O$  as centre and  $OA$  as radius draw a circle  $ABH$ .
- Step 6:** Take any point  $C$  on the circle, By the alternate segments theorem, the major arc  $ACB$  is the required segment of the circle containing the angle  $\theta$ .

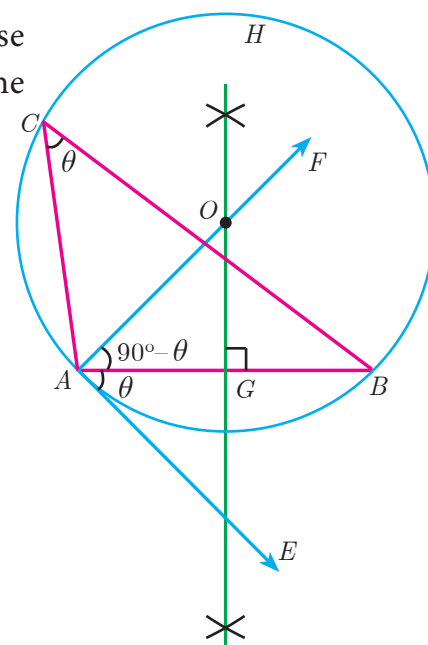

Fig. 4.41

#### Note

If  $C_1, C_2, \dots$  are points on the circle, then all the triangles  $\triangle BAC_1, \triangle BAC_2, \dots$  are with same base and the same vertical angle.



**Construction of a triangle when its base, the vertical angle and the median from the vertex of the base are given.**

**Example 4.17** Construct a  $\triangle PQR$  in which  $PQ = 8$  cm,  $\angle R = 60^\circ$  and the median  $RG$  from  $R$  to  $PQ$  is 5.8 cm. Find the length of the altitude from  $R$  to  $PQ$ .

**Solution**

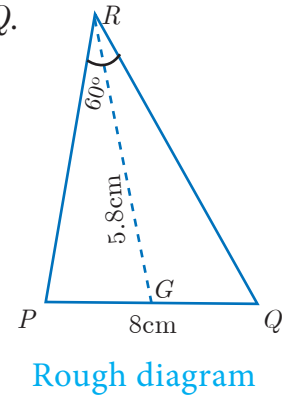
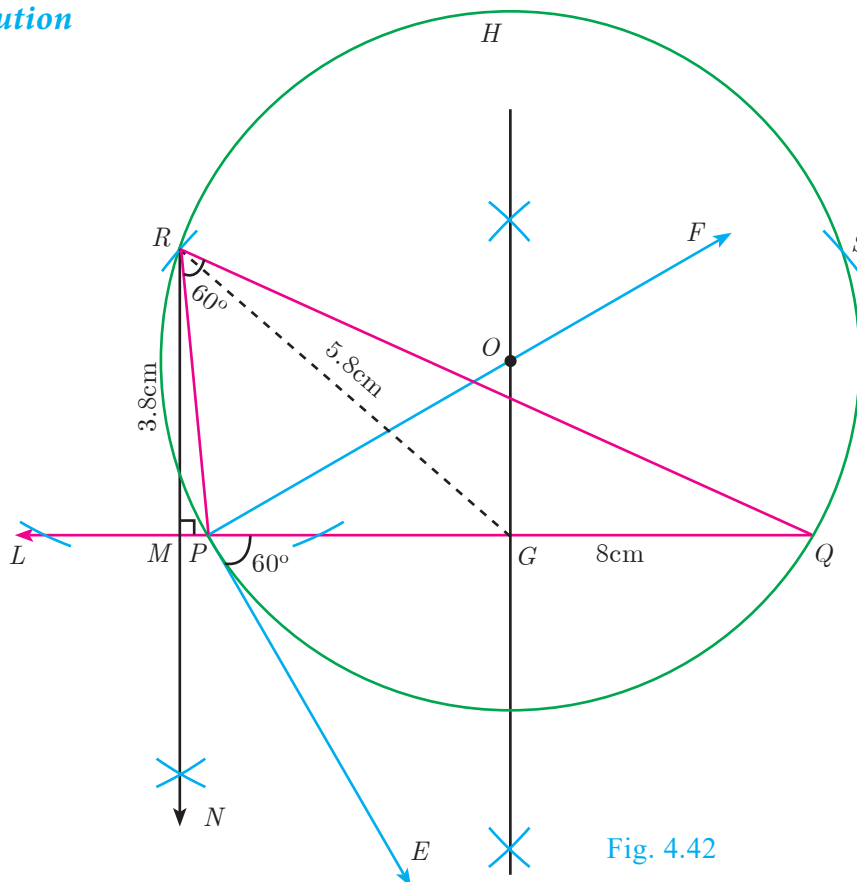

**Construction**

- Step 1:** Draw a line segment  $PQ = 8$ cm.
- Step 2:** At  $P$ , draw  $PE$  such that  $\angle QPE = 60^\circ$ .
- Step 3:** At  $P$ , draw  $PF$  such that  $\angle EPF = 90^\circ$ .
- Step 4:** Draw the perpendicular bisector to  $PQ$ , which intersects  $PF$  at  $O$  and  $PQ$  at  $G$ .
- Step 5:** With  $O$  as centre and  $OP$  as radius draw a circle.
- Step 6:** From  $G$  mark arcs of radius 5.8 cm on the circle. Mark them as  $R$  and  $S$ .
- Step 7:** Join  $PR$  and  $RQ$ . Then  $\triangle PQR$  is the required triangle.
- Step 8:** From  $R$  draw a line  $RN$  perpendicular to  $LQ$ .  
 $LQ$  meets  $RN$  at  $M$
- Step 9:** The length of the altitude is  $RM = 3.8$  cm.

**Note** We can get another  $\triangle PQS$  for the given measurements.

**Construct a triangle when its base, the vertical angle and the altitude from the vertex to the base are given.**

**Example 4.18** Construct a triangle  $\triangle PQR$  such that  $QR = 5$  cm,  $\angle P = 30^\circ$  and the altitude from  $P$  to  $QR$  is of length 4.2 cm.

**Solution**

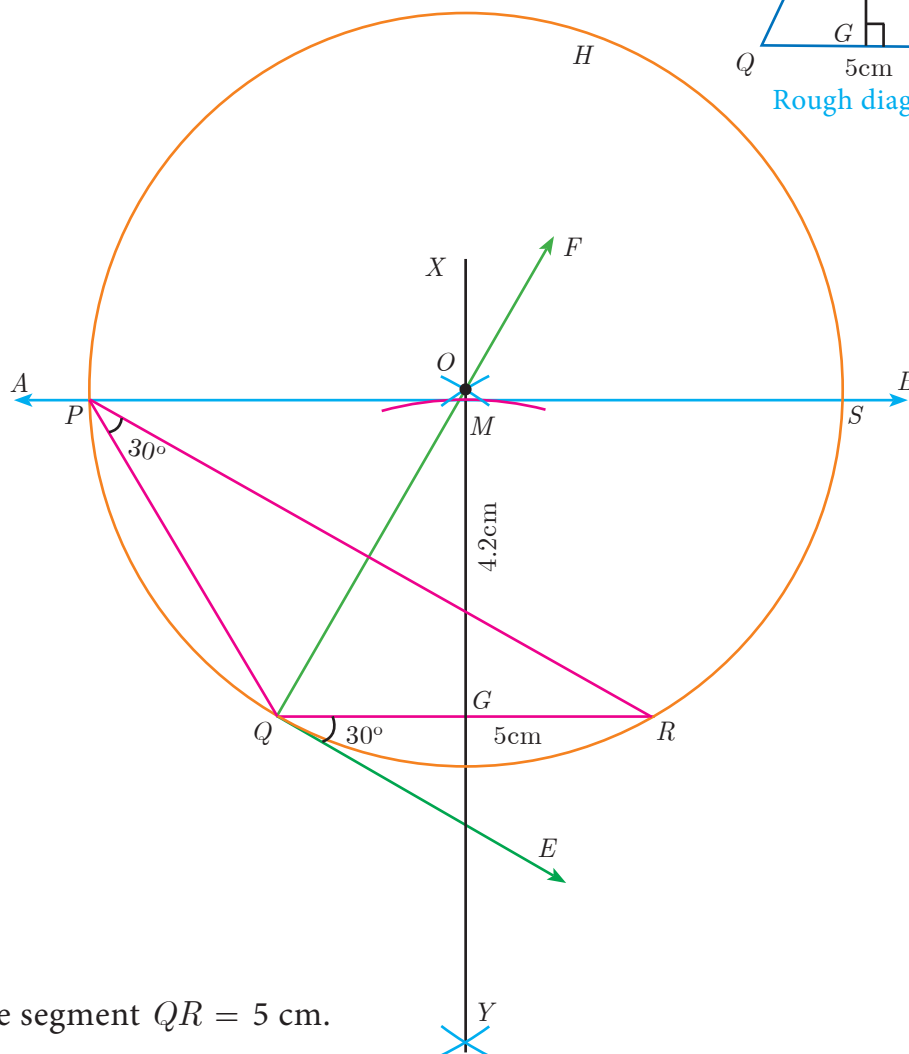
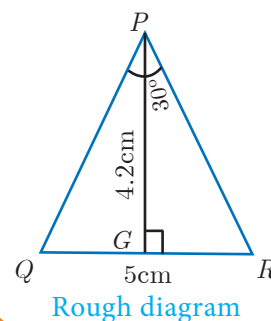

**Construction**

**Step 1 :** Draw a line segment  $QR = 5$  cm.

**Step 2 :** At  $Q$  draw  $QE$  such that  $\angle RQE = 30^\circ$ . Fig. 4.43

**Step 3 :** At  $Q$  draw  $QF$  such that  $\angle EQF = 90^\circ$ .

**Step 4 :** Draw the perpendicular bisector  $XY$  to  $QR$  which intersects  $QF$  at  $O$  and  $QR$  at  $G$ .

**Step 5 :** With  $O$  as centre and  $OQ$  as radius draw a circle.

**Step 6 :** From  $G$  mark an arc in the line  $XY$  at  $M$ , such that  $GM = 4.2$  cm.

**Step 7 :** Draw  $AB$  through  $M$  which is parallel to  $QR$ .

**Step 8 :**  $AB$  meets the circle at  $P$  and  $S$ .

**Step 9 :** Join  $QP$  and  $RP$ . Then  $\triangle PQR$  is the required triangle.

**Note**  $\triangle SQR$  is another required triangle for the given measurements.



**Construct of a triangle when its base, the vertical angle and the point on the base where the bisector of the vertical angle meets the base**

**Example 4.19** Draw a triangle  $ABC$  of base  $BC = 8$  cm,  $\angle A = 60^\circ$  and the bisector of  $\angle A$  meets  $BC$  at  $D$  such that  $BD = 6$  cm.

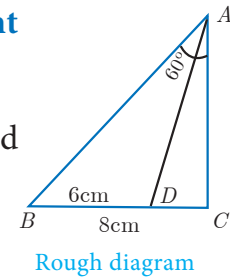

**Solution**

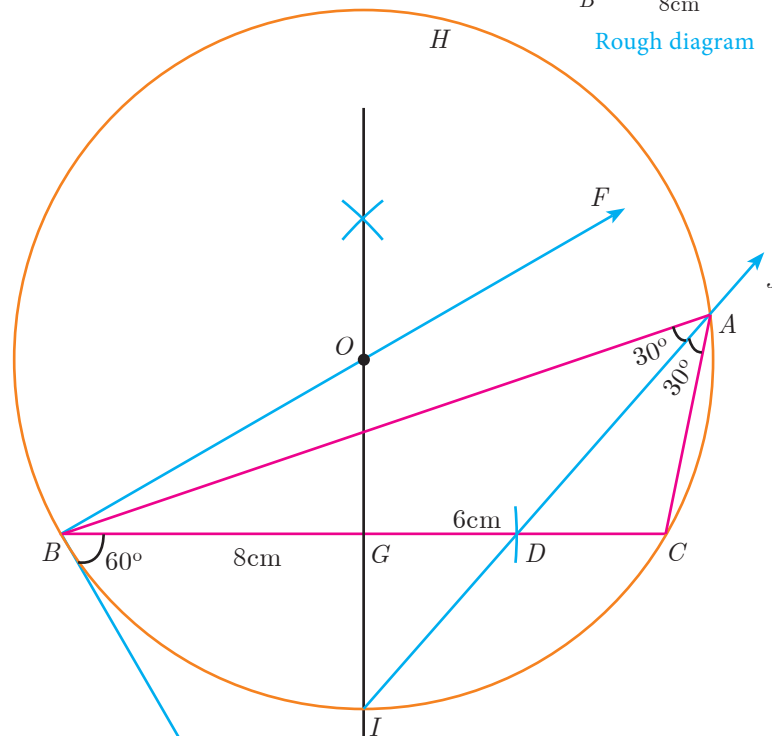

Fig. 4.44

**Construction**

- Step 1 :** Draw a line segment  $BC = 8$  cm.
  - Step 2 :** At  $B$ , draw  $BE$  such that  $\angle CBE = 60^\circ$ .
  - Step 3 :** At  $B$ , draw  $BF$  such that  $\angle EBF = 90^\circ$ .
  - Step 4 :** Draw the perpendicular bisector to  $BC$ , which intersects  $BF$  at  $O$  and  $BC$  at  $G$ .
  - Step 5 :** With  $O$  as centre and  $OB$  as radius draw a circle.
  - Step 6 :** From  $B$ , mark an arc of 6cm on  $BC$  at  $D$ .
  - Step 7 :** The perpendicular bisector intersects the circle at  $I$ . Joint  $ID$ .
  - Step 8 :**  $ID$  produced meets the circle at  $A$ . Now join  $AB$  and  $AC$ .
- Then  $\triangle ABC$  is the required triangle.



**Exercise 4.2**

1. In  $\triangle ABC$ ,  $D$  and  $E$  are points on the sides  $AB$  and  $AC$  respectively such that  $DE \parallel BC$ 
  - (i) If  $\frac{AD}{DB} = \frac{3}{4}$  and  $AC = 15$  cm find  $AE$ .
  - (ii) If  $AD = 8x - 7$ ,  $DB = 5x - 3$ ,  $AE = 4x - 3$  and  $EC = 3x - 1$ , find the value of  $x$ .

2. ABCD is a trapezium in which  $AB \parallel DC$  and  $P, Q$  are points on  $AD$  and  $BC$  respectively, such that  $PQ \parallel DC$  if  $PD = 18$  cm,  $BQ = 35$  cm and  $QC = 15$  cm, find  $AD$ .

3. In  $\triangle ABC$ ,  $D$  and  $E$  are points on the sides  $AB$  and  $AC$  respectively. Show that  $DE \parallel BC$  if  $AB = 12$  cm,  $AD = 8$  cm,  $AE = 12$  cm and  $AC = 18$  cm.

4. In fig. if  $PQ \parallel BC$  and  $PR \parallel CD$  prove that

(i)  $\frac{AR}{AD} = \frac{AQ}{AB}$       (ii)  $\frac{QB}{AQ} = \frac{DR}{AR}$ .

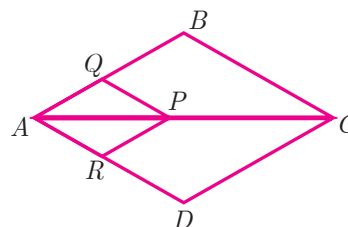

5. Rhombus PQRB is inscribed in  $\triangle ABC$  such that  $\angle B$  is one of its angle.  $P, Q$  and  $R$  lie on  $AB, AC$  and  $BC$  respectively. If  $AB = 12$  cm and  $BC = 6$  cm, find the sides  $PQ, RB$  of the rhombus.

6. In trapezium ABCD,  $AB \parallel DC$ ,  $E$  and  $F$  are points on non-parallel sides  $AD$  and  $BC$  respectively, such that  $EF \parallel AB$ . Show that  $\frac{AE}{ED} = \frac{BF}{FC}$ .

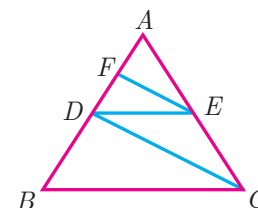

7. In figure  $DE \parallel BC$  and  $CD \parallel EF$ . Prove that  $AD^2 = AB \times AF$ .

8. Check whether  $AD$  is bisector of  $\angle A$  of  $\triangle ABC$  in each of the following

- (i)  $AB = 5$  cm,  $AC = 10$  cm,  $BD = 1.5$  cm and  $CD = 3.5$  cm.
- (ii)  $AB = 4$  cm,  $AC = 6$  cm,  $BD = 1.6$  cm and  $CD = 2.4$  cm.

9. In figure  $\angle QPR = 90^\circ$ ,  $PS$  is its bisector. If  $ST \perp PR$ , prove that  $ST \times (PQ + PR) = PQ \times PR$ .

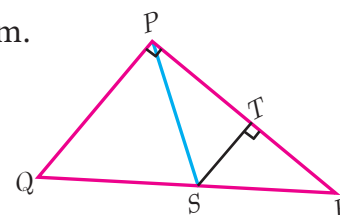

10. ABCD is a quadrilateral in which  $AB = AD$ , the bisector of  $\angle BAC$  and  $\angle CAD$  intersect the sides  $BC$  and  $CD$  at the points  $E$  and  $F$  respectively. Prove that  $EF \parallel BD$ .

11. Construct a  $\triangle PQR$  which the base  $PQ = 4.5$  cm,  $\angle R = 35^\circ$  and the median  $RG$  from  $R$  to  $PG$  is 6 cm.

12. Construct a  $\triangle PQR$  in which  $QR = 5$  cm,  $\angle P = 40^\circ$  and the median  $PG$  from  $P$  to  $QR$  is 4.4 cm. Find the length of the altitude from  $P$  to  $QR$ .

13. Construct a  $\triangle PQR$  such that  $QR = 6.5$  cm,  $\angle P = 60^\circ$  and the altitude from  $P$  to  $QR$  is of length 4.5 cm.

14. Construct a  $\triangle ABC$  such that  $AB = 5.5$  cm,  $\angle C = 25^\circ$  and the altitude from  $C$  to  $AB$  is 4 cm.



15. Draw a triangle  $ABC$  of base  $BC = 5.6$  cm,  $\angle A = 40^\circ$  and the bisector of  $\angle A$  meets  $BC$  at  $D$  such that  $CD = 4$  cm.
16. Draw  $\triangle PQR$  such that  $PQ = 6.8$  cm, vertical angle is  $50^\circ$  and the bisector of the vertical angle meets the base at  $D$  where  $PD = 5.2$  cm.

#### 4.4 Pythagoras Theorem

Among all existing theorems in mathematics, Pythagoras theorem is considered to be the most important because it has maximum number of proofs. There are more than 350 ways of proving Pythagoras theorem through different methods. Each of these proofs was discovered by eminent mathematicians, scholars, engineers and math enthusiasts, including one by the 20<sup>th</sup> American president James Garfield. The book titled “The Pythagorean Proposition” written by Elisha Scott Loomis, published by the National Council of Teaching of Mathematics (NCTM) in America contains 367 proofs of Pythagoras Theorem.

Three numbers  $(a, b, c)$  are said to form Pythagorean Triplet, if they form sides of a right triangle. Thus  $(a, b, c)$  is a Pythagorean Triplet if and only if  $c^2 = a^2 + b^2$ .

Now we are in a position to study this most famous and important theorem not only in Geometry but in whole of mathematics.



#### Activity 4

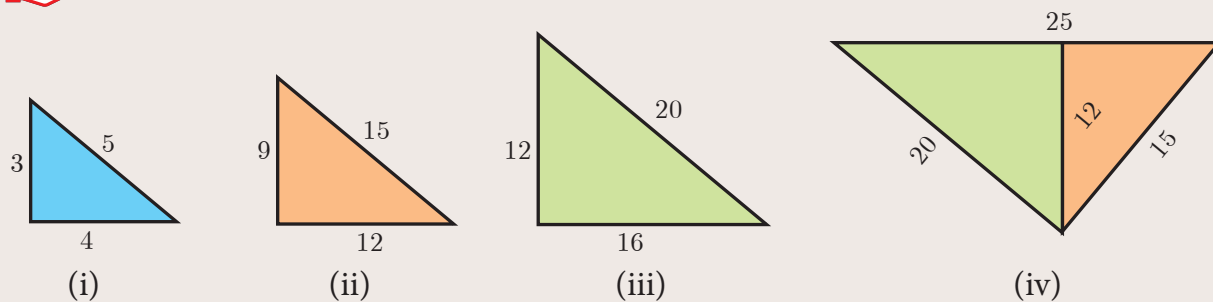

Fig. 4.45

**Step 1:** Take a chart paper, cut out a right angled triangle of measurement as given in triangle (i) .

**Step 2:** Take three more different colour chart papers and cut out three triangles such that the sides of triangle (ii) is three times of the triangle (i), the sides of triangle (iii) is four times of the triangle (i), the sides of triangle (iv) is five times of triangle (i).

**Step 3:** Now keeping the common side length 12 place the triangle (ii) and (iii) over the triangle (iv) such that the sides of these two triangles [(ii) and (iii)] coincide with the triangle (iv).

Observe the hypotenuse side and write down the equation. What do you conclude?

**Note**

- In a right angled triangle, the side opposite to  $90^\circ$  (the right angle) is called the hypotenuse.
- The other two sides are called legs of the right angled triangle.
- The hypotenuse will be the longest side of the triangle.

**Theorem 5 : Pythagoras Theorem**

**Statement**

In a right angle triangle, the square on the hypotenuse is equal to the sum of the squares on the other two sides.

**Proof**

**Given** : In  $\triangle ABC$ ,  $\angle A = 90^\circ$

**To prove** :  $AB^2 + AC^2 = BC^2$

**Construction** : Draw  $AD \perp BC$

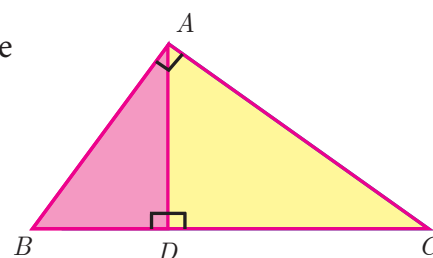

Fig. 4.46

No.	Statement	Reason
1.	Compare $\triangle ABC$ and $\triangle DBA$ $\angle B$ is common $\angle BAC = \angle BDA = 90^\circ$ Therefore, $\triangle ABC \sim \triangle DBA$ $\frac{AB}{BD} = \frac{BC}{AB}$ $AB^2 = BC \times BD \quad \dots (1)$	Given $\angle BAC = 90^\circ$ and by construction $\angle BDA = 90^\circ$  By AA similarity
2.	Compare $\triangle ABC$ and $\triangle DAC$ $\angle C$ is common $\angle BAC = \angle ADC = 90^\circ$ Therefore, $\triangle ABC \sim \triangle DAC$ $\frac{BC}{AC} = \frac{AC}{DC}$ $AC^2 = BC \times DC \quad \dots (2)$	Given $\angle BAC = 90^\circ$ and by construction $\angle ADC = 90^\circ$  By AA similarity

Adding (1) and (2) we get

$$\begin{aligned} AB^2 + AC^2 &= BC \times BD + BC \times DC \\ &= BC(BD + DC) = BC \times BC \\ AB^2 + AC^2 &= BC^2. \end{aligned}$$

Hence the theorem is proved.



In India, Pythagoras Theorem is also referred as “Baudhayana Theorem”.

### Thinking Corner

1. Write down any five Pythagorean triplets?
2. In a right angle triangle the sum of other two angles is \_\_\_\_\_.

## Converse of Pythagoras Theorem

### Statement

If the square of the longest side of a triangle is equal to sums of squares of other two sides, then the triangle is a right angle triangle.



### Activity 5

- (i) Take two consecutive odd numbers.
- (ii) Write the reciprocals of the above numbers and add them. You will get a number of the form  $\frac{p}{q}$ .
- (iii) Add 2 to the denominator of  $\frac{p}{q}$  to get  $q + 2$ .
- (iv) Now consider the numbers  $p, q, q + 2$ . What relation you get between these three numbers? Try for three pairs of consecutive odd numbers and conclude your answer.

### Thinking Corner

Can all the three sides of a right angled triangle be odd numbers? Why?

**Example 4.20** An insect 8 m away initially from the foot of a lamp post which is 6 m tall, crawls towards it moving through a distance. If its distance from the top of the lamp post is equal to the distance it has moved, how far is the insect away from the foot of the lamp post?

**Solution** Distance between the insect and the foot of the lamp post  $BD = 8$  m

The height of the lamp post,  $AB = 6$  m

After moving a distance of  $x$  m, let the insect be at  $C$

Let,  $AC = CD = x$ . Then  $BC = BD - CD = 8 - x$

In  $\triangle ABC$ ,  $\angle B = 90^\circ$

$$AC^2 = AB^2 + BC^2 \text{ gives } x^2 = 6^2 + (8 - x)^2$$

$$x^2 = 36 + 64 - 16x + x^2$$

$$16x = 100 \text{ then } x = 6.25$$

Then,  $BC = 8 - x = 8 - 6.25 = 1.75$  m

Therefore the insect is 1.75 m away from the foot of the lamp post.

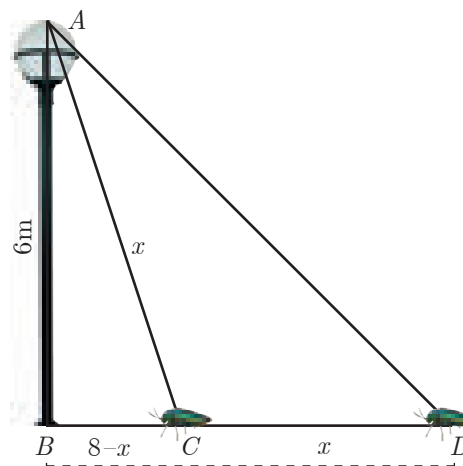

Fig. 4.47

**Example 4.21**  $P$  and  $Q$  are the mid-points of the sides  $CA$  and  $CB$  respectively of a  $\triangle ABC$ , right angled at  $C$ . Prove that  $4(AQ^2 + BP^2) = 5AB^2$ .

**Solution**  $\triangle AQC$  is a right triangle at  $C$ ,  $AQ^2 = AC^2 + QC^2$  ... (1)  
 $\triangle BPC$  is a right triangle at  $C$ ,  $BP^2 = BC^2 + CP^2$  ... (2)  
 $\triangle ABC$  is a right triangle at  $C$ ,  $AB^2 = AC^2 + BC^2$  ... (3)

From (1) and (2),  $AQ^2 + BP^2 = AC^2 + QC^2 + BC^2 + CP^2$

$$\begin{aligned} 4(AQ^2 + BP^2) &= 4AC^2 + 4QC^2 + 4BC^2 + 4CP^2 \\ &= 4AC^2 + (2QC)^2 + 4BC^2 + (2CP)^2 \\ &= 4AC^2 + BC^2 + 4BC^2 + AC^2 \quad (\text{Since } P \text{ and } Q \text{ are mid points}) \\ &= 5(AC^2 + BC^2) \quad (\text{From equation (3)}) \end{aligned}$$

$$4(AQ^2 + BP^2) = 5AB^2$$

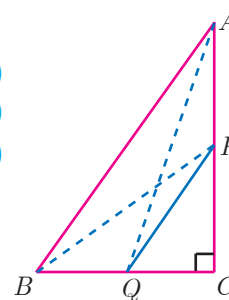

Fig. 4.48

**Example 4.22** What length of ladder is needed to reach a height of 7 ft along the wall when the base of the ladder is 4 ft from the wall? Round off your answer to the next tenth place.

**Solution** Let  $x$  be the length of the ladder.  $BC = 4$  ft,  $AC = 7$  ft.

By Pythagoras theorem we have,  $AB^2 = AC^2 + BC^2$

$$x^2 = 7^2 + 4^2 \Rightarrow x^2 = 49 + 16$$

$$x^2 = 65. \quad \text{Hence, } x = \sqrt{65}$$

The number  $\sqrt{65}$  is between 8 and 8.1.

$$8^2 = 64 < 65 < 65.61 = 8.1^2$$

Therefore, the length of the ladder is approximately 8.1 ft.

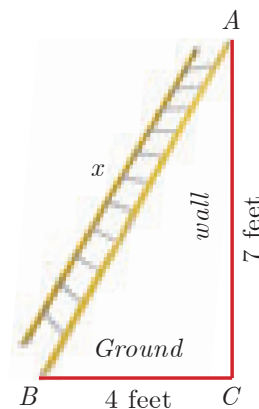

Fig. 4.49

**Example 4.23** An Aeroplane after take off from an airport and flies due north at a speed of 1000 km/hr. At the same time, another aeroplane take off from the same airport and flies due west at a speed of 1200 km/hr. How far apart will be the two planes after  $1\frac{1}{2}$  hours?

**Solution** Let the first aeroplane starts from  $O$  and goes upto  $A$  towards north, (Distance = Speed  $\times$  time)

$$\text{where } OA = \left(1000 \times \frac{3}{2}\right) \text{ km} = 1500 \text{ km}$$

Let the second aeroplane starts from  $O$  at the same time and goes upto  $B$  towards west,

$$\text{where } OB = \left(1200 \times \frac{3}{2}\right) = 1800 \text{ km}$$

The required distance to be found is  $BA$ .

In right angled triangle  $AOB$ ,  $AB^2 = OA^2 + OB^2$

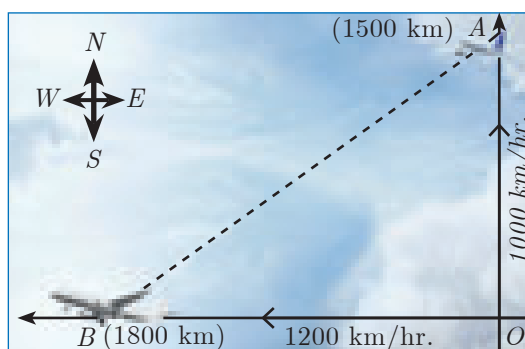

Fig. 4.50



$$\begin{aligned}
 AB^2 &= (1500)^2 + (1800)^2 = 100^2 (15^2 + 18^2) \\
 &= 100^2 \times 549 = 100^2 \times 9 \times 61 \\
 AB &= 100 \times 3 \times \sqrt{61} = 300\sqrt{61} \text{ kms.}
 \end{aligned}$$



### Progress Check

- \_\_\_\_\_ is the longest side of the right angled triangle.
- The first theorem in mathematics is \_\_\_\_\_.
- If the square of the longest side of a triangle is equal to sums of squares of other two sides, then the triangle is \_\_\_\_\_.
- State True or False. Justify them.
  - Pythagoras Theorem is applicable to all triangles.
  - One side of a right angled triangle must always be a multiple of 4.



### Exercise 4.3

- A man goes 18 m due east and then 24 m due north. Find the distance of his current position from the starting point?
- There are two paths that one can choose to go from Sarah's house to James house. One way is to take *C* street, and the other way requires to take *B* street and then *A* street. How much shorter is the direct path along *C* street? (Using figure).

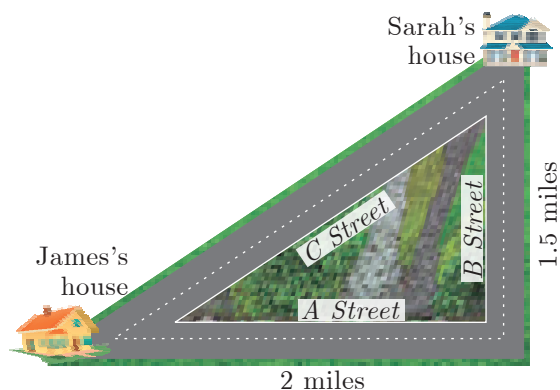

- To get from point *A* to point *B* you must avoid walking through a pond. You must walk 34 m south and 41 m east. To the nearest meter, how many meters would be saved if it were possible to make a way through the pond?
- In the rectangle *WXYZ*,  $XY + YZ = 17$  cm, and  $XZ + YW = 26$  cm. Calculate the length and breadth of the rectangle?
- The hypotenuse of a right triangle is 6 m more than twice of the shortest side. If the third side is 2 m less than the hypotenuse, find the sides of the triangle.
- 5 m long ladder is placed leaning towards a vertical wall such that it reaches the wall at a point 4m high. If the foot of the ladder is moved 1.6 m towards the wall, then find the distance by which the top of the ladder would slide upwards on the wall.



- The perpendicular  $PS$  on the base  $QR$  of a  $\Delta PQR$  intersects  $QR$  at  $S$ , such that  $QS = 3 SR$ . Prove that  $2PQ^2 = 2PR^2 + QR^2$
- In the adjacent figure,  $ABC$  is a right angled triangle with right angle at  $B$  and points  $D, E$  trisect  $BC$ . Prove that  $8AE^2 = 3AC^2 + 5AD^2$

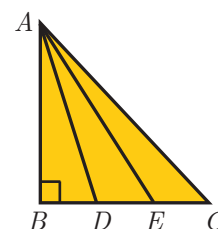

### 4.5 Circles and Tangents

In our day-to-day real life situations, we have seen two lines intersect at a point or do not intersect in a plane. For example, two parallel lines in a railway track, do not intersect. Whereas, grills in a window intersect.

Similarly what happens when a curve and a line is given in a plane? The curve may be parabola, circle or any general curve.

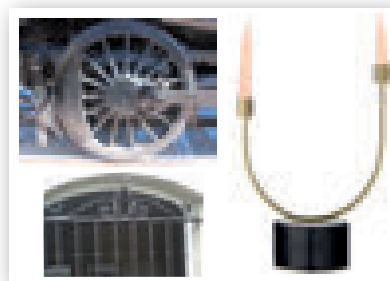

Fig. 4.51

Similarly, what happens when we consider intersection of a line and a circle?

We may get three situations as given in the following diagram

Figure 1	Figure 2	Figure 3
<p>Fig. 4.52(a)</p>	<p>Fig. 4.52(b)</p>	<p>Fig. 4.52(c)</p>
(i) Straight line $PQ$ does not touch the circle.	(i) Straight line $PQ$ touches the circle at a common point $A$ .	(i) Straight line $PQ$ intersects the circle at two points $A$ and $B$ .
(ii) There is no common point between the straight line and circle.	(ii) $PQ$ is called the <b>tangent</b> to the circle at $A$ .	(ii) The line $PQ$ is called a <b>secant</b> of the circle.
(iii) Thus the number of <b>points of intersection</b> of a line and circle is <b>zero</b> .	(iii) Thus the number of <b>points of intersection</b> of a line and circle is <b>one</b> .	(iii) Thus the number of <b>points of intersection</b> of a line and circle is <b>two</b> .

#### Note

The line segment  $AB$  inscribed in the circle in Fig.4.52(c) is called **chord of the circle**. Thus a chord is a sub-section of a secant.

#### DO YOU KNOW?

The word “tangent” comes from the latin word “tangere” which means “to touch” and was introduced by Danish mathematician, ‘Thomas Fineko’ in 1583.

**Definition**

If a line touches the given circle at only one point, then it is called **tangent to the circle**.

**Real life examples of tangents to circles**

(i) When a cycle moves along a road, then the road becomes the tangent at each point when the wheels rolls on it.



Fig. 4.53(a)

(ii) When a stone is tied at one end of a string and is rotated from the other end, then the stone will describe a circle. If we suddenly stop the motion, the stone will go in a direction tangential to the circular motion.

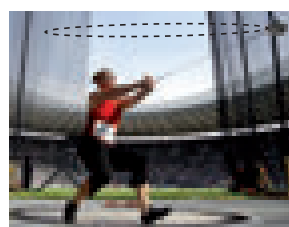
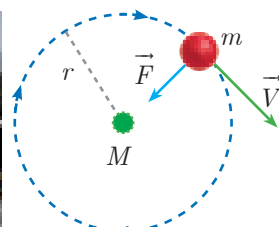

Fig. 4.53(b)



**Some results on circles and tangents**

1. A tangent at any point on a circle and the radius through the point are perpendicular to each other.

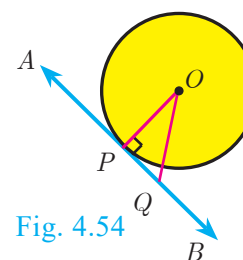

Fig. 4.54

2. (a) No tangent can be drawn from an interior point of the circle.

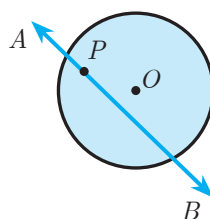

Fig. 4.55(a)

(b) Only one tangent can be drawn at any point on a circle.

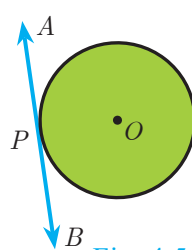

Fig. 4.55(b)

(c) Two tangents can be drawn from any exterior point of a circle.

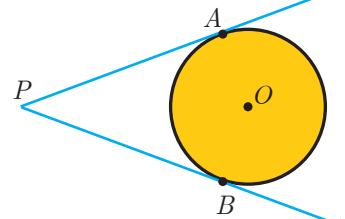

Fig. 4.55(c)

3. The lengths of the two tangents drawn from an exterior point to a circle are equal,

**Proof:** By 1.  $OA \perp PA, OB \perp PB$ . Also  $OA = OB =$  radius,  $OP$  is common side.  $\angle AOP = \angle BOP$

Therefore, by SAS Rule  $\triangle OAP \cong \triangle OBP$ . Hence  $PA = PB$

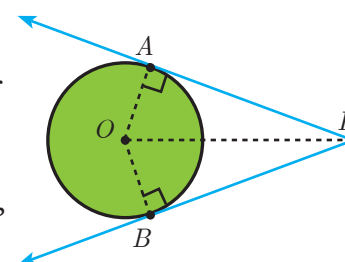

Fig. 4.56

4. If two circles touch externally the distance between their centers is equal to the sum of their radii, that is  $OP = r_1 + r_2$

**Proof:** Let two circles with centers at  $O$  and  $P$  touch other at  $Q$ .

Let  $OQ = r_1$  and  $PQ = r_2$  and let  $r_1 > r_2$ .

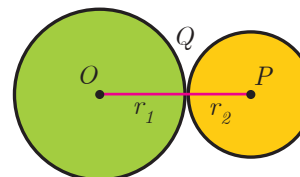

Fig. 4.57

The distance between their centers  $OP = d$ . It is clear from the Fig. 4.57 that when the circles touch externally  $OP = d = OQ + PQ = r_1 + r_2$ .

5. If two circles touch internally, the distance between their centers is equal to the difference of their radii, that is  $OP = r_1 - r_2$ .

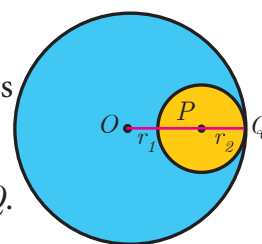

Fig. 4.58

**Proof:** Let two circles with centers at  $O$  and  $P$  touch each other at  $Q$ .

Let  $OQ = r_1$  and  $PQ = r_2$  and let  $r_1 > r_2$ .

The distance between their centers  $OP = d$ . It is clear from the Fig. 4.58 that when the circles touch internally,  $OP = d = OQ - PQ$

$$OP = r_1 - r_2.$$

6. The two direct common tangents drawn to the circles are equal in length, that is  $AB = CD$ .

**Proof:**

The lengths of tangents drawn from  $P$  to the two circles are equal.

Therefore,  $PA = PC$  and  $PB = PD$ .

$$\Rightarrow PA - PB = PC - PD$$

$$AB = CD$$

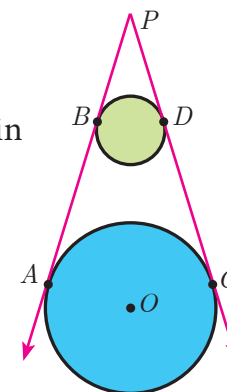

Fig. 4.59

### Thinking Corner

1. Can we draw two tangents parallel to each other on a circle?
2. Can we draw two tangents perpendicular to each other on a circle?

### Alternate segment

In the Fig. 4.60, the chord  $PQ$  divides the circle into two segments. The tangent  $AB$  is drawn such that it touches the circle at  $P$ .

The angle in the alternate segment for  $\angle QPB$  ( $\angle 1$ ) is  $\angle QSP$  ( $\angle 1$ ) and that for  $\angle QPA$  ( $\angle 2$ ) is  $\angle PTQ$  ( $\angle 2$ ).

### Theorem 6 : Alternate Segment theorem

#### Statement

If a line touches a circle and from the point of contact a chord is drawn, the angles between the tangent and the chord are respectively equal to the angles in the corresponding alternate segments.

#### Proof

**Given :** A circle with centre at  $O$ , tangent  $AB$  touches the circle at  $P$  and  $PQ$  is a chord.  $S$  and  $T$  are two points on the circle in the opposite sides of chord  $PQ$ .

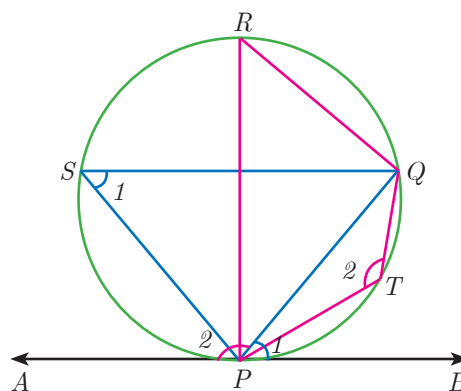

Fig. 4.60

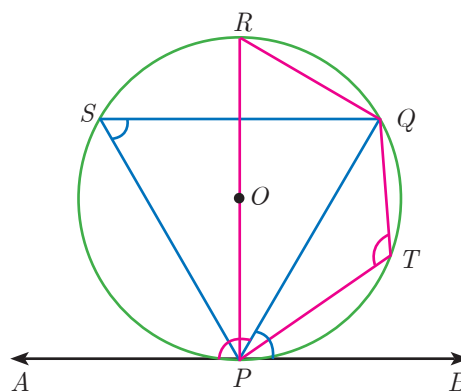

Fig. 4.61

**To prove** : (i)  $\angle QPB = \angle PSQ$  and (ii)  $\angle QPA = \angle PTQ$

**Construction:** Draw the diameter  $POR$ . Draw  $QR$ ,  $QS$  and  $PS$ .

No.	Statement	Reason
1.	$\angle RPB = 90^\circ$ Now, $\angle RPQ + \angle QPB = 90^\circ$ ... <b>(1)</b>	Diameter RP is perpendicular to tangent AB.
2.	In $\triangle RPQ$ , $\angle PQR = 90^\circ$ ... <b>(2)</b>	Angle in a semicircle is $90^\circ$ .
3.	$\angle QRP + \angle RPQ = 90^\circ$ ... <b>(3)</b>	In a right angled triangle, sum of the two acute angles is $90^\circ$ .
4.	$\angle RPQ + \angle QPB = \angle QRP + \angle RPQ$ $\angle QPB = \angle QRP$ ... <b>(4)</b>	From <b>(1)</b> and <b>(3)</b> .
5.	$\angle QRP = \angle PSQ$ ... <b>(5)</b>	Angles in the same segment are equal.
6.	$\angle QPB = \angle PSQ$ ... <b>(6)</b>	From <b>(4)</b> and <b>(5)</b> ; Hence (i) is proved.
7.	$\angle QPB + \angle QPA = 180^\circ$ ... <b>(7)</b>	Linear pair of angles.
8.	$\angle PSQ + \angle PTQ = 180^\circ$ ... <b>(8)</b>	Sum of opposite angles of a cyclic quadrilateral is $180^\circ$ .
9.	$\angle QPB + \angle QPA = \angle PSQ + \angle PTQ$	From <b>(7)</b> and <b>(8)</b> .
10.	$\angle QPB + \angle QPA = \angle QPB + \angle PTQ$	$\angle QPB = \angle PSQ$ from <b>(6)</b>
11.	$\angle QPA = \angle PTQ$	Hence (ii) is proved. This completes the proof.

**Example 4.24** Find the length of the tangent drawn from a point whose distance from the centre of a circle is 5 cm and radius of the circle is 3 cm.

**Solution** Given  $OP = 5$  cm, radius  $r = 3$  cm

To find the length of tangent  $PT$ .

In right angled  $\triangle OTP$ ,

$$OP^2 = OT^2 + PT^2 \text{ (by Pythagoras theorem)}$$

$$5^2 = 3^2 + PT^2 \text{ gives } PT^2 = 25 - 9 = 16$$

Length of the tangent  $PT = 4$  cm

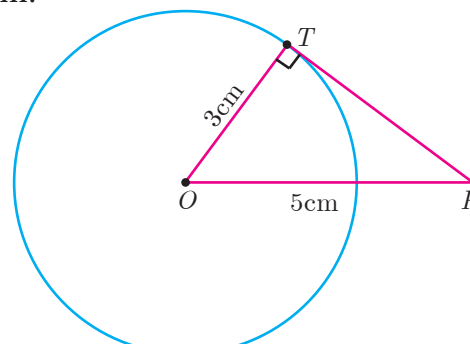

Fig. 4.62

**Example 4.25** PQ is a chord of length 8 cm to a circle of radius 5 cm. The tangents at P and Q intersect at a point T. Find the length of the tangent TP.

**Solution** Let  $TR = y$ . Since, OT is perpendicular bisector of PQ.

$$PR = QR = 4 \text{ cm}$$

$$\text{In } \triangle ORP, OP^2 = OR^2 + PR^2$$

$$OR^2 = OP^2 - PR^2$$

$$OR^2 = 5^2 - 4^2 = 25 - 16 = 9 \Rightarrow OR = 3 \text{ cm}$$

$$OT = OR + RT = 3 + y \quad \dots (1)$$

$$\text{In } \triangle PRT, TP^2 = TR^2 + PR^2 \quad \dots (2)$$

and  $\triangle OPT$  we have,  $OT^2 = TP^2 + OP^2$

$$OT^2 = (TR^2 + PR^2) + OP^2 \quad (\text{substitute for } TP^2 \text{ from (2)})$$

$$(3 + y)^2 = y^2 + 4^2 + 5^2 \quad (\text{substitute for } OT \text{ from (1)})$$

$$9 + 6y + y^2 = y^2 + 16 + 25$$

$$6y = 41 - 9 \text{ we get } y = \frac{16}{3}$$

From (2),  $TP^2 = TR^2 + PR^2$

$$TP^2 = \left(\frac{16}{3}\right)^2 + 4^2 = \frac{256}{9} + 16 = \frac{400}{9} \text{ so, } TP = \frac{20}{3} \text{ cm}$$

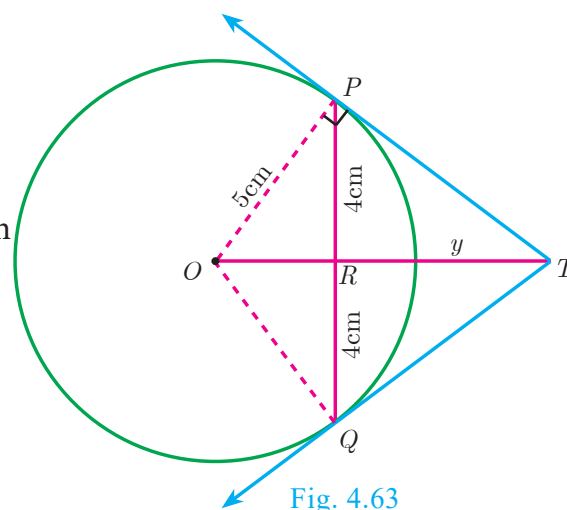

Fig. 4.63

**Example 4.26** In Fig.4.64, O is the centre of a circle. PQ is a chord and the tangent PR at P makes an angle of  $50^\circ$  with PQ. Find  $\angle POQ$ .

**Solution**  $\angle OPQ = 90^\circ - 50^\circ = 40^\circ$  (angle between the radius and tangent is  $90^\circ$ )

$$OP = OQ \quad (\text{Radii of a circle are equal})$$

$$\angle OPQ = \angle OQP = 40^\circ \quad (\triangle OPQ \text{ is isosceles})$$

$$\angle POQ = 180^\circ - \angle OPQ - \angle OQP$$

$$\angle POQ = 180^\circ - 40^\circ - 40^\circ = 100^\circ$$

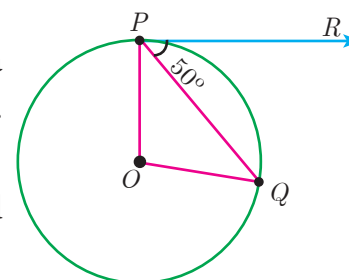

Fig. 4.64

**Example 4.27** In Fig.4.65,  $\triangle ABC$  is circumscribing a circle. Find the length of BC.

**Solution**  $AN = AM = 3 \text{ cm}$  (Tangents drawn from same external point are equal)

$$BN = BL = 4 \text{ cm}$$

$$CL = CM = AC - AM = 9 - 3 = 6 \text{ cm}$$

$$\text{Gives } BC = BL + CL = 4 + 6 = 10 \text{ cm}$$

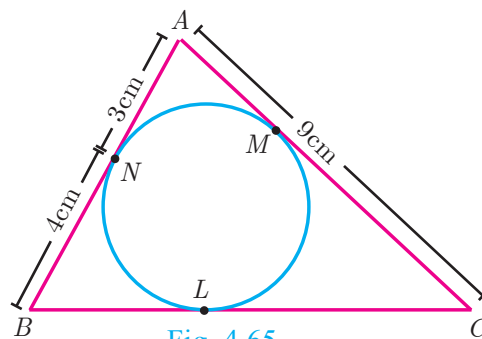

Fig. 4.65

**Example 4.28** If radii of two concentric circles are 4 cm and 5 cm then find the length of the chord of one circle which is a tangent to the other circle.

**Solution**  $OA = 4$  cm,  $OB = 5$  cm; also  $OA \perp BC$ .

$$OB^2 = OA^2 + AB^2$$

$$5^2 = 4^2 + AB^2 \text{ gives } AB^2 = 9$$

Therefore  $AB = 3$  cm

$BC = 2AB$  hence  $BC = 2 \times 3 = 6$  cm

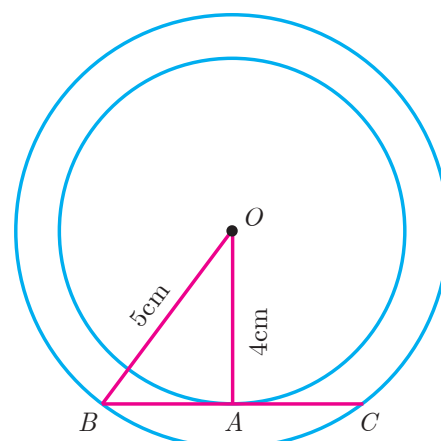

Fig. 4.66

### 4.5.1 Construction

#### Construction of tangents to a circle

Now let us discuss how to draw

- (i) a tangent to a circle using its centre
- (ii) a tangent to a circle using alternate segment theorem
- (iii) pair of tangents from an external point

#### Construction of a tangent to a circle (Using the centre)

**Example 4.29** Draw a circle of radius 3 cm. Take a point  $P$  on this circle and draw a tangent at  $P$ .

**Solution** Given, radius  $r = 3$  cm

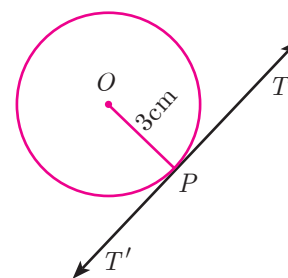

Rough diagram

#### Construction

Step 1: Draw a circle with centre at  $O$  of radius 3 cm.

Step 2: Take a point  $P$  on the circle. Join  $OP$ .

Step 3: Draw perpendicular line to  $OP$  which passes through  $P$ .

Step 4:  $TT'$  is the required tangent.

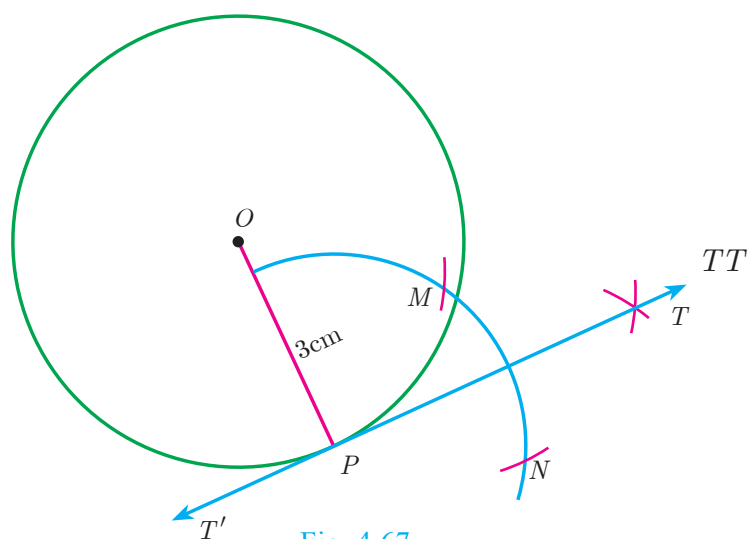

Fig. 4.67

#### Construct of a tangent to a circle (Using alternate segment theorem)

**Example 4.30** Draw a circle of radius 4 cm. At a point  $L$  on it draw a tangent to the circle using the alternate segment.

**Solution**

Given, radius = 4 cm

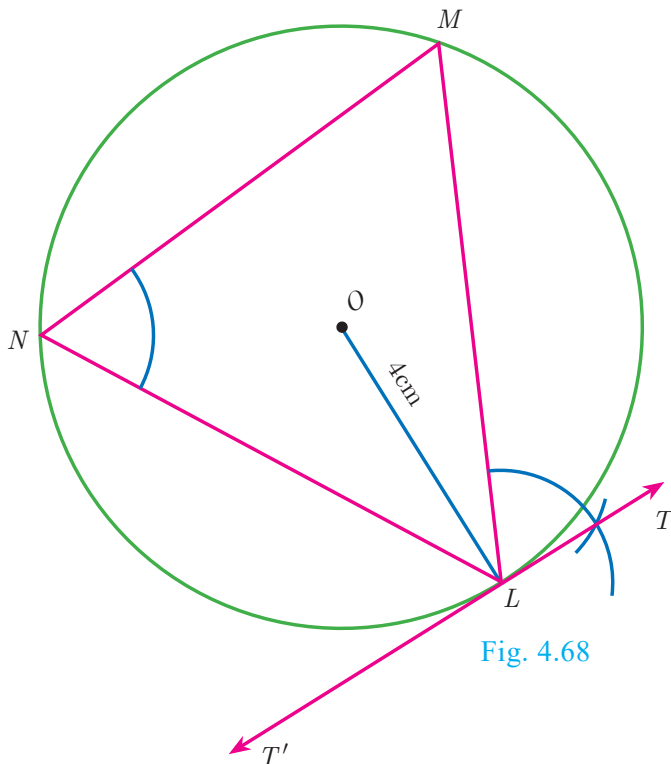
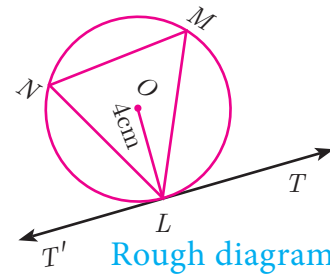

Fig. 4.68



**Construction**

- Step 1 : With  $O$  as the centre, draw a circle of radius 4 cm.
- Step 2 : Take a point  $L$  on the circle. Through  $L$  draw any chord  $LM$ .
- Step 3 : Take a point  $N$  distinct from  $L$  and  $M$  on the circle, so that  $L$ ,  $M$  and  $N$  are in anti-clockwise direction. Join  $LN$  and  $NM$ .
- Step 4 : Through  $L$  draw a tangent  $TT'$  such that  $\angle TLM = \angle MNL$ .
- Step 5 :  $TT'$  is the required tangent.

**Construction of pair of tangents to a circle from an external point  $P$ .**

**Example 4.31** Draw a circle of diameter 6 cm from a point  $P$ , which is 8 cm away from its centre. Draw the two tangents  $PA$  and  $PB$  to the circle and measure their lengths.

**Solution** Given, diameter ( $d$ ) = 6 cm, we find radius ( $r$ ) =  $\frac{6}{2} = 3$  cm

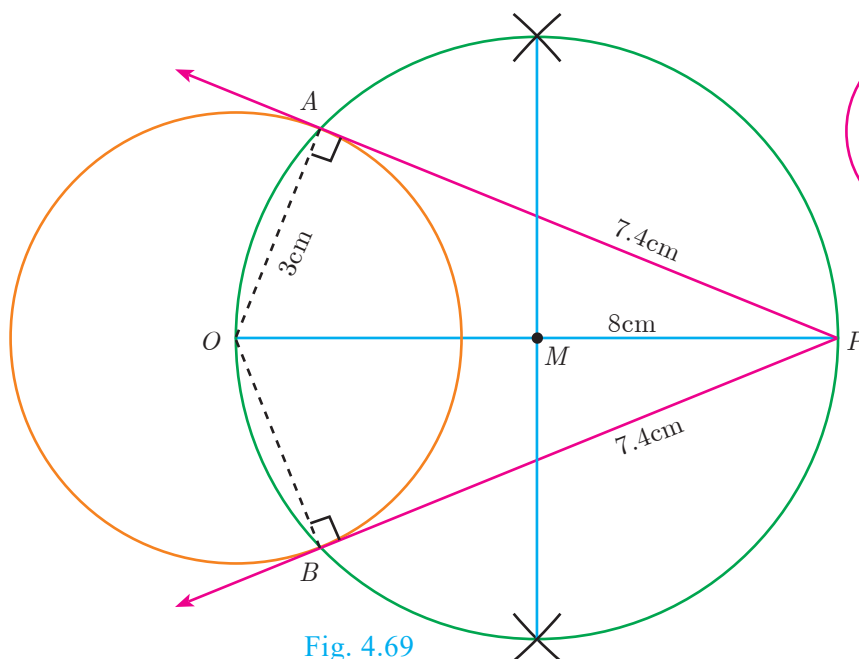
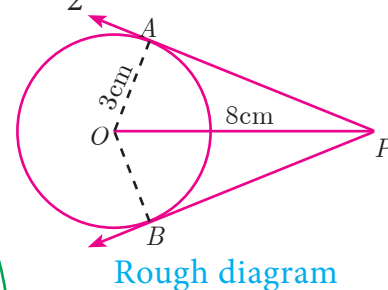

Fig. 4.69



Rough diagram



### Construction

- Step 1: With centre at  $O$ , draw a circle of radius 3 cm.
- Step 2: Draw a line  $OP$  of length 8 cm.
- Step 3: Draw a perpendicular bisector of  $OP$ , which cuts  $OP$  at  $M$ .
- Step 4: With  $M$  as centre and  $MO$  as radius, draw a circle which cuts previous circle at  $A$  and  $B$ .
- Step 5: Join  $AP$  and  $BP$ .  $AP$  and  $BP$  are the required tangents. Thus length of the tangents are  $PA = PB = 7.4$  cm.

**Verification :** In the right angle triangle  $OAP$ ,  $PA^2 = OP^2 - OA^2 = 8^2 - 3^2 = 64 - 9 = 55$   
 $PA = \sqrt{55} = 7.4$  cm (approximately).

### 4.6 Concurrency Theorems

#### Definition

A **cevian** is a line segment that extends from one vertex of a triangle to the opposite side. In the diagram,  $AD$  is a cevian, from  $A$ .

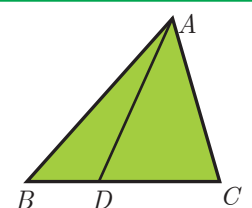

#### Special cevians

- (i) A median is a **cevian** that divides the opposite side into two congruent (equal) lengths.
- (ii) An altitude is a **cevian** that is perpendicular to the opposite side.
- (iii) An angle bisector is a **cevian** that bisects the corresponding angle.



The term **cevian** comes from the name of Italian engineer Giovanni Ceva, who proved a well known theorem about cevians.

#### Ceva's Theorem (without proof)

##### Statement

Let  $ABC$  be a triangle and let  $D, E, F$  be points on lines  $BC, CA, AB$  respectively. Then the cevians  $AD, BE, CF$  are concurrent if and only if  $\frac{BD}{DC} \times \frac{CE}{EA} \times \frac{AF}{FB} = 1$  where the lengths are directed. This also works for the reciprocal of each of the ratios as the reciprocal of 1 is 1.

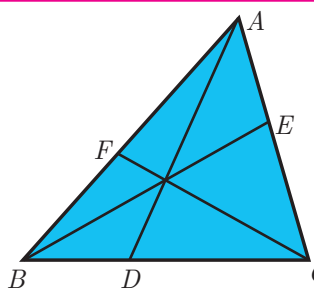

Fig. 4.70



#### Giovanni Ceva (Dec 7, 1647 – June 15, 1734)

In 1686, Ceva was designated as the professor of Mathematics, University of Mantua and worked there for the rest of the life. In 1678, he published an important theorem on synthetic geometry for a triangle called Ceva's theorem.

Ceva also rediscovered and published in the Journal *Opuscula mathematica and Geometria motus* in 1692. He applied these ideas in mechanics and hydraulics.

#### Note

The cevians do not necessarily lie within the triangle, although they do in the diagram.

### Menelaus Theorem (without proof)

#### Statement

A necessary and sufficient condition for points  $P, Q, R$  on the respective sides  $BC, CA, AB$  (or their extension) of a triangle  $ABC$  to be collinear is that  $\frac{BP}{PC} \times \frac{CQ}{QA} \times \frac{AR}{RB} = -1$  where all segments in the formula are directed segments.

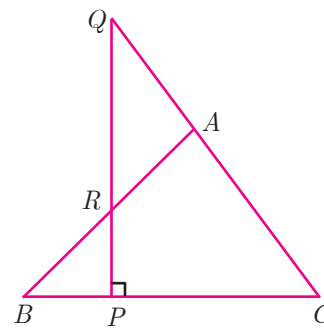

Fig. 4.71



#### Menelaus

Menelaus was a Greek mathematician who lived during the Roman empire in both Alexandria and Rome during first century (CE). His work was largely on the geometry of spheres.

Menelaus theorem was first discussed in his book, sphaerica and later mentioned by Ptolemy in his work Almagest.

Menelaus theorem proves that spheres are made up of spherical triangles.

#### Note

- Menelaus theorem can also be given as  $BP \times CQ \times AR = -PC \times QA \times RB$ .
- If  $BP$  is replaced by  $PB$  (or)  $CQ$  by  $QC$  (or)  $AR$  by  $RA$ , or if any one of the six directed line segments  $BP, PC, CQ, QA, AR, RB$  is interchanged, then the product will be 1.

**Example 4.32** Show that in a triangle, the medians are concurrent.

**Solution** Medians are line segments joining each vertex to the midpoint of the corresponding opposite sides.

Thus medians are the cevians where  $D, E, F$  are midpoints of  $BC, CA$  and  $AB$  respectively.

Since  $D$  is a midpoint of  $BC, BD = DC$  so  $\frac{BD}{DC} = 1 \dots (1)$

Since,  $E$  is a midpoint of  $CA, CE = EA$  so  $\frac{CE}{EA} = 1 \dots (2)$

Since,  $F$  is a midpoint of  $AB, AF = FB$  so  $\frac{AF}{FB} = 1 \dots (3)$

Thus, multiplying (1), (2) and (3) we get,

$$\frac{BD}{DC} \times \frac{CE}{EA} \times \frac{AF}{FB} = 1 \times 1 \times 1 = 1$$

And so, Ceva's theorem is satisfied.

Hence the Medians are concurrent.

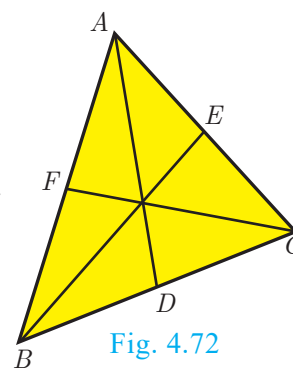

Fig. 4.72



Centroid is the point of concurrence of the median of a triangle.



**Example 4.33** In  $\triangle ABC$ , points  $D, E, F$  lie on  $BC, CA, AB$  respectively. Suppose  $AB, AC$  and  $BC$  have lengths 13, 14 and 15 respectively. If  $\frac{AF}{FB} = \frac{2}{5}$  and  $\frac{CE}{EA} = \frac{5}{8}$ . Find  $BD$  and  $DC$ .

**Solution** Given that  $AB = 13, AC = 14$  and  $BC = 15$ .

Let  $BD = x$  and  $DC = y$

Using Ceva's theorem, we have,  $\frac{BD}{DC} \times \frac{CE}{EA} \times \frac{AF}{FB} = 1$  ... (1)

Substitute the values of  $\frac{AF}{FB}$  and  $\frac{CE}{EA}$  in (1),

we have  $\frac{BD}{DC} \times \frac{5}{8} \times \frac{2}{5} = 1$

$$\frac{x}{y} \times \frac{10}{40} = 1 \text{ we get, } \frac{x}{y} \times \frac{1}{4} = 1. \text{ Hence, } x = 4y \quad \dots (2)$$

$$BC = BD + DC = 15 \text{ so, } x + y = 15 \quad \dots (3)$$

From (2), using  $x = 4y$  in (3) we get,  $4y + y = 15$  gives  $5y = 15$  then  $y = 3$

Substitute  $y = 3$  in (3) we get,  $x = 12$ . Hence  $BD = 12, DC = 3$ .

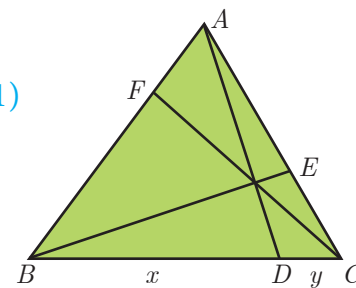

Fig. 4.73

**Example 4.34** In a garden containing several trees, three particular trees  $P, Q, R$  are located in the following way,  $BP = 2$  m,  $CQ = 3$  m,  $RA = 10$  m,  $PC = 6$  m,  $QA = 5$  m,  $RB = 2$  m, where  $A, B, C$  are points such that  $P$  lies on  $BC$ ,  $Q$  lies on  $AC$  and  $R$  lies on  $AB$ . Check whether the trees  $P, Q, R$  lie on a same straight line.

**Solution** By Menelaus's theorem, the trees  $P, Q, R$  will be collinear (lie on same straight line)

$$\text{if } \frac{BP}{PC} \times \frac{CQ}{QA} \times \frac{RA}{RB} = 1 \quad \dots (1)$$

Given  $BP = 2$  m,  $CQ = 3$  m,  $RA = 10$  m,  $PC = 6$  m,  $QA = 5$  m and  $RB = 2$  m

Substituting these values in (1) we get,  $\frac{BP}{PC} \times \frac{CQ}{QA} \times \frac{RA}{RB} = \frac{2}{6} \times \frac{3}{5} \times \frac{10}{2} = \frac{60}{60} = 1$

Hence the trees  $P, Q, R$  lie on a same straight line.

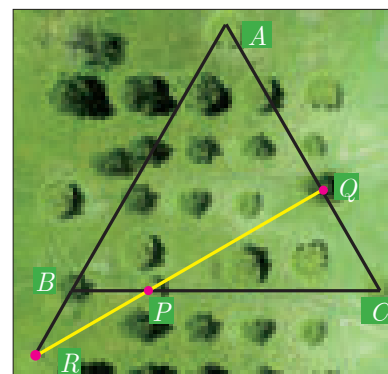

Fig. 4.74



### Progress Check

1. A straight line that touches a circle at a common point is called a \_\_\_\_\_.
2. A chord is a subsection of \_\_\_\_\_.
3. The lengths of the two tangents drawn from \_\_\_\_\_ point to a circle are equal.
4. No tangent can be drawn from \_\_\_\_\_ of the circle.
5. \_\_\_\_\_ is a cevian that divides the angle, into two equal halves.



**Exercise 4.4**

- The length of the tangent to a circle from a point  $P$ , which is 25 cm away from the centre is 24 cm. What is the radius of the circle?
- $\triangle LMN$  is a right angled triangle with  $\angle L = 90^\circ$ . A circle is inscribed in it. The lengths of the sides containing the right angle are 6 cm and 8 cm. Find the radius of the circle.

- A circle is inscribed in  $\triangle ABC$  having sides 8 cm, 10 cm and 12 cm as shown in figure, Find  $AD$ ,  $BE$  and  $CF$ .

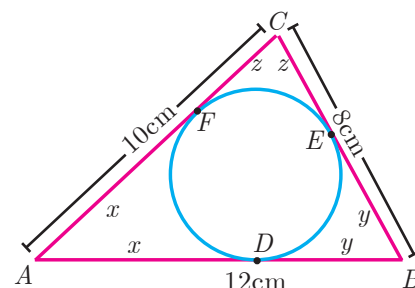

- $PQ$  is a tangent drawn from a point  $P$  to a circle with centre  $O$  and  $QOR$  is a diameter of the circle such that  $\angle POR = 120^\circ$ . Find  $\angle OPQ$ .
- A tangent  $ST$  to a circle touches it at  $B$ .  $AB$  is a chord such that  $\angle ABT = 65^\circ$ . Find  $\angle AOB$ , where “ $O$ ” is the centre of the circle.

- In figure,  $O$  is the centre of the circle with radius 5 cm.  $T$  is a point such that  $OT = 13$  cm and  $OT$  intersects the circle  $E$ , if  $AB$  is the tangent to the circle at  $E$ , find the length of  $AB$ .

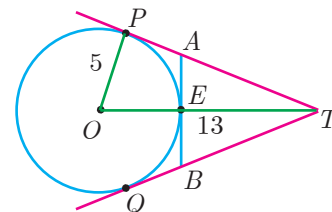

- In two concentric circles, a chord of length 16 cm of larger circle becomes a tangent to the smaller circle whose radius is 6 cm. Find the radius of the larger circle.
- Two circles with centres  $O$  and  $O'$  of radii 3 cm and 4 cm, respectively intersect at two points  $P$  and  $Q$ , such that  $OP$  and  $O'P$  are tangents to the two circles. Find the length of the common chord  $PQ$ .
- Show that the angle bisectors of a triangle are concurrent.
- An artist has created a triangular stained glass window and has one strip of small length left before completing the window. She needs to figure out the length of left out portion based on the lengths of the other sides as shown in the figure.

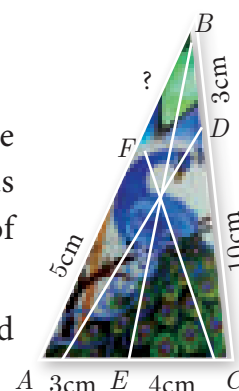

- Draw a tangent at any point  $R$  on the circle of radius 3.4 cm and centre at  $P$ ?
- Draw a circle of radius 4.5 cm. Take a point on the circle. Draw the tangent at that point using the alternate segment theorem.
- Draw the two tangents from a point which is 10 cm away from the centre of a circle of radius 5 cm. Also, measure the lengths of the tangents.
- Take a point which is 11 cm away from the centre of a circle of radius 4 cm and draw the two tangents to the circle from that point.
- Draw the two tangents from a point which is 5 cm away from the centre of a circle of diameter 6 cm. Also, measure the lengths of the tangents.



16. Draw a tangent to the circle from the point  $P$  having radius 3.6 cm, and centre at  $O$ . Point  $P$  is at a distance 7.2 cm from the centre.



**Exercise 4.5**



**Multiple choice questions**

- If in triangles  $ABC$  and  $EDF$ ,  $\frac{AB}{DE} = \frac{BC}{FD}$  then they will be similar, when  
 (A)  $\angle B = \angle E$       (B)  $\angle A = \angle D$       (C)  $\angle B = \angle D$       (D)  $\angle A = \angle F$
- In  $\triangle LMN$ ,  $\angle L = 60^\circ$ ,  $\angle M = 50^\circ$ . If  $\triangle LMN \sim \triangle PQR$  then the value of  $\angle R$  is  
 (A)  $40^\circ$       (B)  $70^\circ$       (C)  $30^\circ$       (D)  $110^\circ$
- If  $\triangle ABC$  is an isosceles triangle with  $\angle C = 90^\circ$  and  $AC = 5$  cm, then  $AB$  is  
 (A) 2.5 cm      (B) 5 cm      (C) 10 cm      (D)  $5\sqrt{2}$  cm

- In a given figure  $ST \parallel QR$ ,  $PS = 2$  cm and  $SQ = 3$  cm. Then the ratio of the area of  $\triangle PQR$  to the area of  $\triangle PST$  is  
 (A) 25 : 4      (B) 25 : 7  
 (C) 25 : 11      (D) 25 : 13

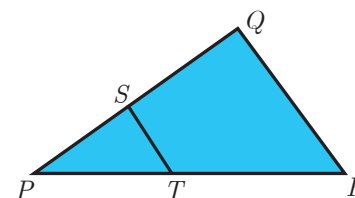

- The perimeters of two similar triangles  $\triangle ABC$  and  $\triangle PQR$  are 36 cm and 24 cm respectively. If  $PQ = 10$  cm, then the length of  $AB$  is  
 (A)  $6\frac{2}{3}$  cm      (B)  $\frac{10\sqrt{6}}{3}$  cm      (C)  $66\frac{2}{3}$  cm      (D) 15 cm

- If in  $\triangle ABC$ ,  $DE \parallel BC$ .  $AB = 3.6$  cm,  $AC = 2.4$  cm and  $AD = 2.1$  cm then the length of  $AE$  is  
 (A) 1.4 cm      (B) 1.8 cm      (C) 1.2 cm      (D) 1.05 cm
- In a  $\triangle ABC$ ,  $AD$  is the bisector of  $\angle BAC$ . If  $AB = 8$  cm,  $BD = 6$  cm and  $DC = 3$  cm. The length of the side  $AC$  is  
 (A) 6 cm      (B) 4 cm      (C) 3 cm      (D) 8 cm

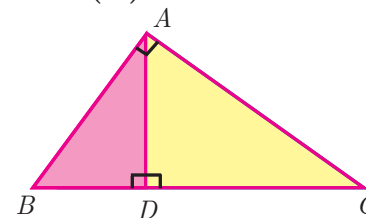

- In the adjacent figure  $\angle BAC = 90^\circ$  and  $AD \perp BC$  then  
 (A)  $BD \cdot CD = BC^2$       (B)  $AB \cdot AC = BC^2$   
 (C)  $BD \cdot CD = AD^2$       (D)  $AB \cdot AC = AD^2$

- Two poles of heights 6 m and 11 m stand vertically on a plane ground. If the distance between their feet is 12 m, what is the distance between their tops?  
 (A) 13 m      (B) 14 m      (C) 15 m      (D) 12.8 m
- In the given figure,  $PR = 26$  cm,  $QR = 24$  cm,  $\angle PAQ = 90^\circ$ ,  $PA = 6$  cm and  $QA = 8$  cm. Find  $\angle PQR$   
 (A)  $80^\circ$       (B)  $85^\circ$       (C)  $75^\circ$       (D)  $90^\circ$

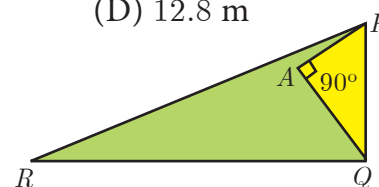

11. A tangent is perpendicular to the radius at the  
 (A) centre (B) point of contact (C) infinity (D) chord
12. How many tangents can be drawn to the circle from an exterior point?  
 (A) one (B) two (C) infinite (D) zero
13. The two tangents from an external points  $P$  to a circle with centre at  $O$  are  $PA$  and  $PB$ . If  $\angle APB = 70^\circ$  then the value of  $\angle AOB$  is  
 (A)  $100^\circ$  (B)  $110^\circ$  (C)  $120^\circ$  (D)  $130^\circ$

14. In figure  $CP$  and  $CQ$  are tangents to a circle with centre at  $O$ .  $ARB$  is another tangent touching the circle at  $R$ . If  $CP = 11$  cm and  $BC = 7$  cm, then the length of  $BR$  is  
 (A) 6 cm (B) 5 cm  
 (C) 8 cm (D) 4 cm

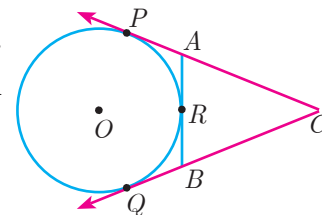

15. In figure if  $PR$  is tangent to the circle at  $P$  and  $O$  is the centre of the circle, then  $\angle POQ$  is  
 (A)  $120^\circ$  (B)  $100^\circ$   
 (C)  $110^\circ$  (D)  $90^\circ$

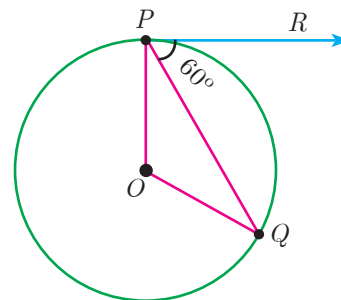

### Unit Exercise - 4



1. In the figure, if  $BD \perp AC$  and  $CE \perp AB$ , prove that

(i)  $\triangle AEC \sim \triangle ADB$  (ii)  $\frac{CA}{AB} = \frac{CE}{DB}$

2. In the given figure  $AB \parallel CD \parallel EF$ .

If  $AB = 6$  cm,  $CD = x$  cm,  $EF = 4$  cm,  $BD = 5$  cm and  $DE = y$  cm. Find  $x$  and  $y$ .

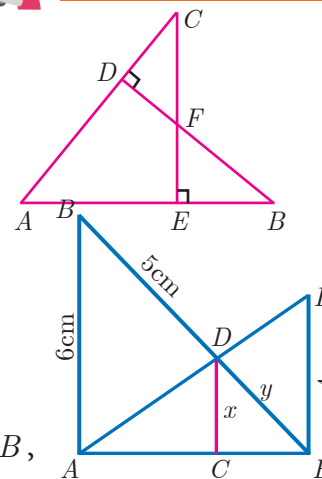

3.  $O$  is any point inside a triangle  $ABC$ . The bisector of  $\angle AOB$ ,  $\angle BOC$  and  $\angle COA$  meet the sides  $AB$ ,  $BC$  and  $CA$  in point  $D$ ,  $E$  and  $F$  respectively. Show that  $AD \times BE \times CF = DB \times EC \times FA$

4. In the figure,  $ABC$  is a triangle in which  $AB = AC$ . Points  $D$  and  $E$  are points on the side  $AB$  and  $AC$  respectively such that  $AD = AE$ . Show that the points  $B$ ,  $C$ ,  $E$  and  $D$  lie on a same circle.

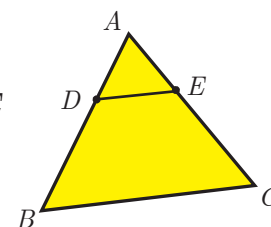

5. Two trains leave a railway station at the same time. The first train travels due west and the second train due north. The first train travels at a speed of 20 km/hr and the second train travels at 30 km/hr. After 2 hours, what is the distance between them?

6.  $D$  is the mid point of side  $BC$  and  $AE \perp BC$ . If  $BC = a$ ,  $AC = b$ ,  $AB = c$ ,  $ED = x$ ,  $AD = p$  and  $AE = h$ , prove that
- (i)  $b^2 = p^2 + ax + \frac{a^2}{4}$       (ii)  $c^2 = p^2 - ax + \frac{a^2}{4}$       (iii)  $b^2 + c^2 = 2p^2 + \frac{a^2}{2}$
7. A man whose eye-level is 2 m above the ground wishes to find the height of a tree. He places a mirror horizontally on the ground 20 m from the tree and finds that if he stands at a point  $C$  which is 4 m from the mirror  $B$ , he can see the reflection of the top of the tree. How height is the tree?
8. An Emu which is 8 feet tall is standing at the foot of a pillar which is 30 feet high. It walks away from the pillar. The shadow of the Emu falls beyond Emu. What is the relation between the length of the shadow and the distance from the Emu to the pillar?
9. Two circles intersect at  $A$  and  $B$ . From a point  $P$  on one of the circles lines  $PAC$  and  $PBD$  are drawn intersecting the second circle at  $C$  and  $D$ . Prove that  $CD$  is parallel to the tangent at  $P$ .
10. Let  $ABC$  be a triangle and  $D, E, F$  are points on the respective sides  $AB, BC, AC$  (or their extensions). Let  $AD : DB = 5 : 3$ ,  $BE : EC = 3 : 2$  and  $AC = 21$ . Find the length of the line segment  $CF$ .

### Points to Remember

- Two triangles are similar if
  - (i) their corresponding angles are equal
  - (ii) their corresponding sides are in the same ratio or proportional.
- Any congruent triangles are similar but the converse is not true
- $AA$  similarity criterion is same as the  $AAA$  similarity criterion.
- If one angle of a triangle is equal to one angle of another triangle and the sides including these angles are in the same ratio then the triangles are similar. (SAS)
- If three sides of a triangle are proportional to the corresponding sides of another triangle, then the two triangles are similar (SSS)
- If two triangles are similar then the ratio of the corresponding sides is equal to the ratio of the corresponding perimeters.
- The ratio of the area of two similar triangles are equal to the ratio of the squares of their corresponding sides.
- A tangent to a circle will be perpendicular to the radius at the point of contact.
- Two tangents can be drawn from any exterior point of a circle.
- The lengths of the two tangents drawn from an exterior point to a circle are equal.
- Two direct common tangents drawn to two circles are equal in length.

ICT CORNER



ICT 4.1

Expected results



**Step 1:** Open the Browser type the URL Link given below (or) Scan the QR Code. 10th Standard Mathematics Chapter named “Geometry” will open. Select the work sheet “Angular Bisector theorem”

**Step 2:** In the given worksheet you can see Triangle ABC and its Angular Bisector CD. and you can change the triangle by dragging the Vertices. Observe the ratios given on Left hand side and learn the theorem.

Step 1

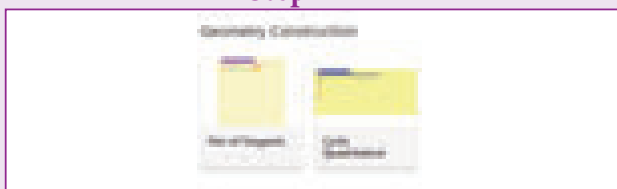

Step 2

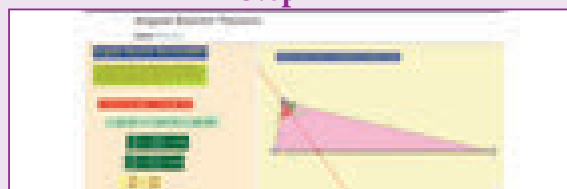

ICT 4.2

Expected results

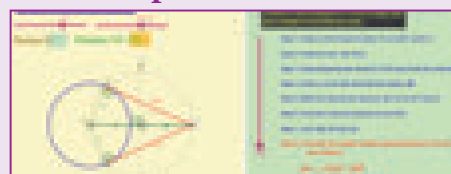

**Step 1:** Open the Browser type the URL Link given below (or) Scan the QR Code. 10th Standard Mathematics Chapter named “Geometry” will open. Select the work sheet “Pair of Tangents”.

**Step 2:** In the given worksheet you can change the radius and Distance by moving the sliders given on Left hand side. Move the Slider in the middle to see the steps for construction.

Step 1

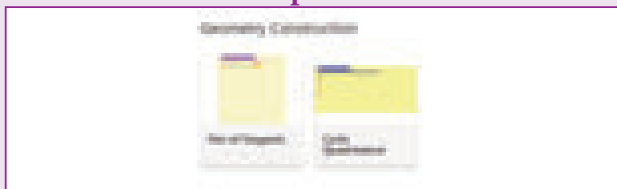

Step 2

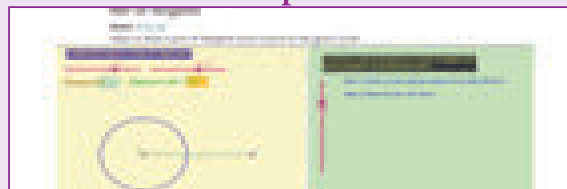

You can repeat the same steps for other activities

<https://www.geogebra.org/m/jfr2zzgy#chapter/356194>  
or Scan the QR Code.





# COORDINATE GEOMETRY

“A line is breadthless length” - Euclid

## 5

**Apollonius** was born at Perga, in modern day Turkey. His greatest work was called “conics” which introduced curves like circle, parabola geometrically. He wrote six other books all related to the **basics of modern day coordinate geometry**.

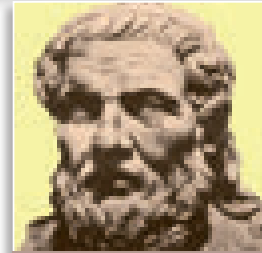

Apollonius  
262 - 190 BC (BCE)

His ideas were applied to study planetary theory and solve practical problems. He developed the sundial and contributed to other branches of science using his exceptional geometric skills. For this reason, Apollonius is hailed as “**The Great Geometer**”.



### Learning Outcomes

- To find area of a triangle formed by three given points.
- To find area of a quadrilateral formed by four given points.
- To find the slope of a straight line.
- To determine equation of a straight line in various forms.
- To find the equation of a line parallel to the line  $ax + by + c = 0$ .
- To find the equation of a line perpendicular to the line  $ax + by + c = 0$ .



## 5.1 Introduction

Coordinate geometry, also called Analytical geometry is a branch of mathematics, in which curves in a plane are represented by algebraic equations. For example, the equation  $x^2 + y^2 = 1$ , describes a circle of unit radius in the plane. Thus coordinate geometry can be seen as a branch of mathematics which interlinks algebra and geometry, where algebraic equations are represented by geometric curves. This connection makes it possible to reformulate problems in geometry to problems in algebra and vice versa. Thus, in coordinate geometry, the algebraic equations have visual representations thereby making our understanding much deeper. For instance, the first degree equation in two variables  $ax + by + c = 0$  represents a straight line in a plane. Overall, coordinate geometry is a tool to understand concepts visually and created new branches of mathematics in modern times.

In the earlier classes, we initiated the study of coordinate geometry where we studied about coordinate axes, coordinate plane, plotting of points in a plane, distance between two points, section formulae, etc. All these concepts form the basics of coordinate geometry. Let us now recall some of the basic formulae.

## Recall

### Distance between two points

Distance between two points  $A(x_1, y_1)$  and  $B(x_2, y_2)$  is

$$|AB| = d = \sqrt{(x_2 - x_1)^2 + (y_2 - y_1)^2}.$$

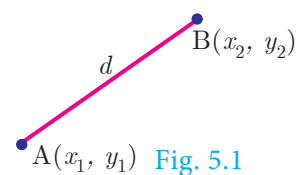

Fig. 5.1

### Mid-point of line segment

The mid-point  $M$ , of the line segment joining

$$A(x_1, y_1) \text{ and } B(x_2, y_2) \text{ is } \left( \frac{x_1 + x_2}{2}, \frac{y_1 + y_2}{2} \right).$$

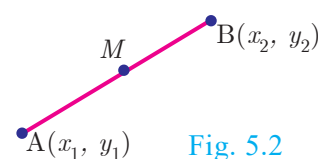

Fig. 5.2

## Section Formula

### Internal Division

Let  $A(x_1, y_1)$  and  $B(x_2, y_2)$  be two distinct points such that point  $P(x, y)$  divides  $AB$  internally in the ratio  $m:n$ .

Then the coordinates of  $P$  are given by  $\left( \frac{mx_2 + nx_1}{m + n}, \frac{my_2 + ny_1}{m + n} \right)$ .

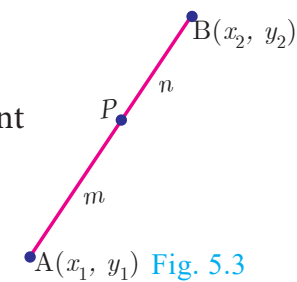

Fig. 5.3

### External Division

Let  $A(x_1, y_1)$  and  $B(x_2, y_2)$  be two distinct points such that the point  $P(x, y)$  divides  $AB$  externally in the ratio  $m:n$ .

Then the coordinates of  $P$  are given by  $\left( \frac{mx_2 - nx_1}{m - n}, \frac{my_2 - ny_1}{m - n} \right)$ .

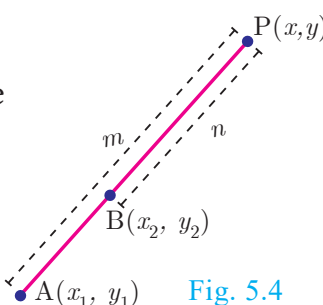

Fig. 5.4

### Centroid of a triangle

The coordinates of the centroid  $G$  of a triangle with vertices

$$A(x_1, y_1), B(x_2, y_2) \text{ and } C(x_3, y_3) \text{ are given by } \left( \frac{x_1 + x_2 + x_3}{3}, \frac{y_1 + y_2 + y_3}{3} \right).$$

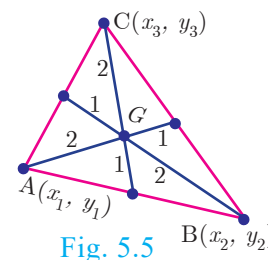

Fig. 5.5





## Progress Check

1. Complete the following table.

S.No.	Points	Distance	Mid Point	Internal		External	
				Point	Ratio	Point	Ratio
(i)	(3, 4), (5, 5)				2:3		2:3
(ii)	(-7,13),(-3,1)			$\left(-\frac{13}{3}, 5\right)$		(-13, 15)	

2.  $A(0,5)$ ,  $B(5,0)$  and  $C(-4,-7)$  are vertices of a triangle then its centroid will be at \_\_\_\_\_.

## 5.2 Area of a Triangle

In your earlier classes, you have studied how to calculate the area of a triangle when its base and corresponding height (altitude) are given. You have used the formula.

$$\text{Area of triangle} = \frac{1}{2} \times \text{base} \times \text{altitude sq.units.}$$

With any three non-collinear points  $A(x_1, y_1)$ ,  $B(x_2, y_2)$  and  $C(x_3, y_3)$  on a plane, we can form a triangle  $ABC$ .

Using distance between two points formula, we can calculate  $AB = c$ ,  $BC = a$ ,  $CA = b$ .  $a, b, c$  represent the lengths of the sides of the triangle  $ABC$ .

Using  $2s = a + b + c$ , we can calculate the area of triangle  $ABC$  by using the Heron's formula  $\sqrt{s(s-a)(s-b)(s-c)}$ . But this procedure of finding length of sides of  $\triangle ABC$  and then calculating its area will be a tedious procedure.

There is an elegant way of finding area of a triangle using the coordinates of its vertices. We shall discuss such a method below.

Let  $ABC$  be any triangle whose vertices are at  $A(x_1, y_1)$ ,  $B(x_2, y_2)$  and  $C(x_3, y_3)$ .

Draw  $AP$ ,  $BQ$  and  $CR$  perpendiculars from  $A$ ,  $B$  and  $C$  to the  $x$ -axis, respectively.

Clearly  $ABQP$ ,  $APRC$  and  $BQRC$  are all trapeziums.

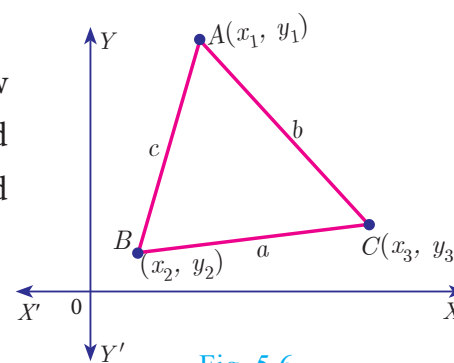

Fig. 5.6

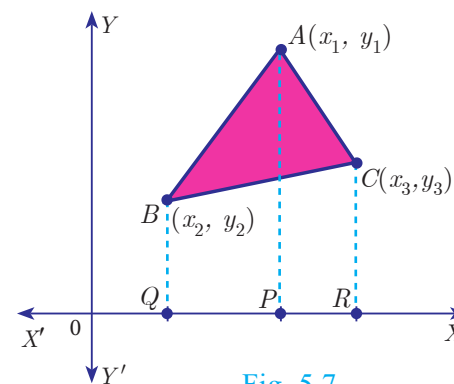

Fig. 5.7

Now from Fig.5.7, it is clear that

Area of  $\triangle ABC$

$$= \text{Area of trapezium } ABQP + \text{Area of trapezium } APRC - \text{Area of trapezium } BQRC.$$

You also know that, the area of trapezium

$$= \frac{1}{2} \times (\text{sum of parallel sides}) \times (\text{perpendicular distance between the parallel sides})$$

Therefore, Area of  $\triangle ABC$

$$\begin{aligned} &= \frac{1}{2}(BQ + AP)QP + \frac{1}{2}(AP + CR)PR - \frac{1}{2}(BQ + CR)QR \\ &= \frac{1}{2}(y_2 + y_1)(x_1 - x_2) + \frac{1}{2}(y_1 + y_3)(x_3 - x_1) - \frac{1}{2}(y_2 + y_3)(x_3 - x_2) \\ &= \frac{1}{2}\{x_1(y_2 - y_3) + x_2(y_3 - y_1) + x_3(y_1 - y_2)\} \end{aligned}$$

Thus, the area of  $\triangle ABC$  is the absolute value of the expression

$$= \frac{1}{2}\{x_1(y_2 - y_3) + x_2(y_3 - y_1) + x_3(y_1 - y_2)\} \text{ sq.units.}$$

The vertices  $A(x_1, y_1)$ ,  $B(x_2, y_2)$  and  $C(x_3, y_3)$  of  $\triangle ABC$  are said to be “taken in order” if  $A$ ,  $B$ ,  $C$  are taken in anticlockwise direction. If we do this, then area of  $\triangle ABC$  will never be negative.

### Another form

The following pictorial representation helps us to write the above formula very easily.

$$\text{Area of } \triangle ABC = \frac{1}{2} \begin{vmatrix} x_1 & x_2 & x_3 & x_1 \\ y_1 & y_2 & y_3 & y_1 \end{vmatrix}$$

$$= \frac{1}{2}\{(x_1 y_2 + x_2 y_3 + x_3 y_1) - (x_2 y_1 + x_3 y_2 + x_1 y_3)\} \text{ sq.units.}$$

### Note

“As the area of a triangle can never be negative, we must take the absolute value, in case area happens to be negative”.



### Progress Check

The vertices of  $\triangle PQR$  are  $P(0, -4)$ ,  $Q(3, 1)$  and  $R(-8, 1)$

1. Draw  $\triangle PQR$  on a graph paper.
2. Check if  $\triangle PQR$  is equilateral.
3. Find the area of  $\triangle PQR$ .
4. Find the coordinates of  $M$ , the mid-point of  $QP$ .
5. Find the coordinates of  $N$ , the mid-point of  $QR$ .
6. Find the area of  $\triangle MPN$ .
7. What is the ratio between the areas of  $\triangle MPN$  and  $\triangle PQR$ ?

### 5.2.1 Collinearity of three points

If three distinct points  $A(x_1, y_1)$ ,  $B(x_2, y_2)$  and  $C(x_3, y_3)$  are collinear, then we cannot form a triangle, because for such a triangle there will be no altitude (height). Therefore, three points  $A(x_1, y_1)$ ,  $B(x_2, y_2)$  and  $C(x_3, y_3)$  will be **collinear** if the area of  $\Delta ABC = 0$ .

**Note**

**Another condition for collinearity**

If  $A(x_1, y_1)$ ,  $B(x_2, y_2)$  and  $C(x_3, y_3)$  are collinear points, then

$$x_1(y_2 - y_3) + x_2(y_3 - y_1) + x_3(y_1 - y_2) = 0$$

or  $x_1y_2 + x_2y_3 + x_3y_1 = x_1y_3 + x_2y_1 + x_3y_2$ .

Similarly, if the area of  $\Delta ABC$  is zero, then the three points lie on the same straight line. Thus, three distinct points  $A(x_1, y_1)$ ,  $B(x_2, y_2)$  and  $C(x_3, y_3)$  will be collinear if and only if area of  $\Delta ABC = 0$ .

### 5.3 Area of a Quadrilateral

If  $ABCD$  is a quadrilateral, then considering the diagonal  $AC$ , we can split the quadrilateral  $ABCD$  into two triangles  $ABC$  and  $ACD$ .

Using area of triangle formula given its vertices, we can calculate the areas of triangles  $ABC$  and  $ACD$ .

Now, Area of the quadrilateral  $ABCD$   
 = Area of triangle  $ABC$  + Area of triangle  $ACD$

We use this information to find area of a quadrilateral when its vertices are given.

Let  $A(x_1, y_1)$ ,  $B(x_2, y_2)$ ,  $C(x_3, y_3)$  and  $D(x_4, y_4)$  be the vertices of a quadrilateral  $ABCD$ .

Now, Area of quadrilateral  $ABCD$   
 = Area of the  $\Delta ABD$  + Area of the  $\Delta BCD$  (Fig 5.9)

$$\begin{aligned} &= \frac{1}{2} \{ (x_1y_2 + x_2y_4 + x_4y_1) - (x_2y_1 + x_4y_2 + x_1y_4) \} \\ &+ \frac{1}{2} \{ (x_2y_3 + x_3y_4 + x_4y_2) - (x_3y_2 + x_4y_3 + x_2y_4) \} \\ &= \frac{1}{2} \{ (x_1y_2 + x_2y_3 + x_3y_4 + x_4y_1) - (x_2y_1 + x_3y_2 + x_4y_3 + x_1y_4) \} \\ &= \frac{1}{2} \{ (x_1 - x_3)(y_2 - y_4) - (x_2 - x_4)(y_1 - y_3) \} \text{ sq.units.} \end{aligned}$$

The following pictorial representation helps us to write the above formula very easily. Take the vertices  $A(x_1, y_1)$ ,  $B(x_2, y_2)$ ,  $C(x_3, y_3)$  and  $D(x_4, y_4)$  in counter-clockwise direction and write them column-wise as that of the area of a triangle.

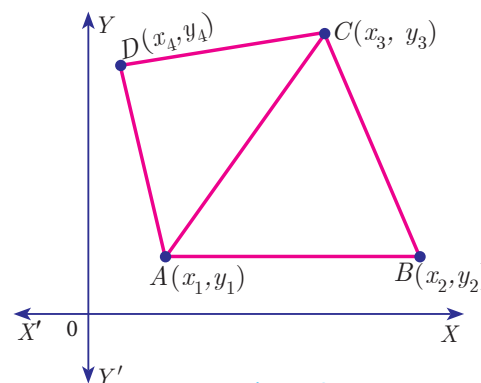

Fig. 5.8

**Thinking Corner**

How many triangles exist, whose area is zero?

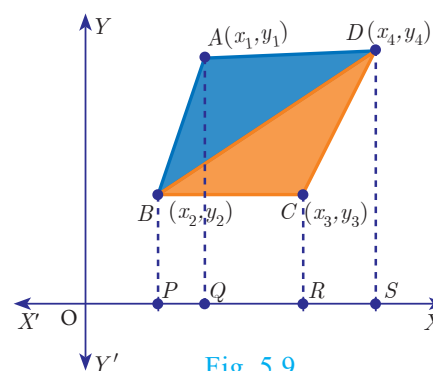

Fig. 5.9

$$\begin{aligned} \text{Area of the quadrilateral ABCD} &= \frac{1}{2} \begin{vmatrix} x_1 & x_2 & x_3 & x_4 & x_1 \\ y_1 & y_2 & y_3 & y_4 & y_1 \end{vmatrix} \\ &= \frac{1}{2} \{ (x_1y_2 + x_2y_3 + x_3y_4 + x_4y_1) - (x_2y_1 + x_3y_2 + x_4y_3 + x_1y_4) \} \text{ sq.units.} \end{aligned}$$

**Note**

- To find the area of a quadrilateral, we divide it into triangular regions, which have no common area and then add the area of these regions.
- The area of the quadrilateral is never negative. That is, we always take the area of quadrilateral as positive.

**Thinking Corner**

1. If the area of a quadrilateral formed by the points  $(a, a)$ ,  $(-a, a)$ ,  $(a, -a)$  and  $(-a, -a)$ , where  $a \neq 0$  is 64 square units, then identify the type of the quadrilateral
2. Find all possible values of  $a$ .

**Example 5.1** Find the area of the triangle whose vertices are  $(-3, 5)$ ,  $(5, 6)$  and  $(5, -2)$

**Solution** Plot the points in a rough diagram and take them in counter-clockwise order.

Let the vertices be  $A(-3, 5)$ ,  $B(5, -2)$ ,  $C(5, 6)$

$\downarrow$                        $\downarrow$                        $\downarrow$   
 $(x_1, y_1)$              $(x_2, y_2)$              $(x_3, y_3)$

The area of  $\triangle ABC$  is

$$\begin{aligned} &= \frac{1}{2} \{ (x_1y_2 + x_2y_3 + x_3y_1) - (x_2y_1 + x_3y_2 + x_1y_3) \} \\ &= \frac{1}{2} \{ (6 + 30 + 25) - (25 - 10 - 18) \} \\ &= \frac{1}{2} \{ 61 + 3 \} \\ &= \frac{1}{2} (64) = 32 \text{ sq.units} \end{aligned}$$

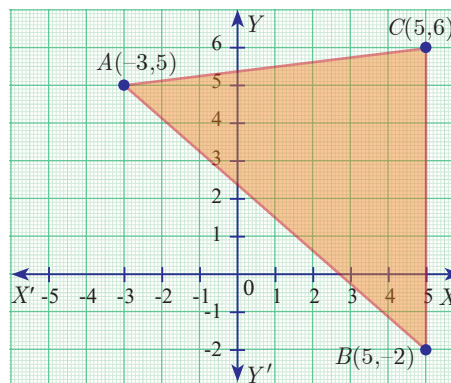

Fig. 5.10

**Example 5.2** Show that the points  $P(-1.5, 3)$ ,  $Q(6, -2)$ ,  $R(-3, 4)$  are collinear.

**Solution** The points are  $P(-1.5, 3)$ ,  $Q(6, -2)$ ,  $R(-3, 4)$

$$\begin{aligned} \text{Area of } \triangle PQR &= \frac{1}{2} \{ (x_1y_2 + x_2y_3 + x_3y_1) - (x_2y_1 + x_3y_2 + x_1y_3) \} \\ &= \frac{1}{2} \{ (3 + 24 - 9) - (18 + 6 - 6) \} = \frac{1}{2} \{ 18 - 18 \} = 0 \end{aligned}$$

Therefore, the given points are collinear.

**Example 5.3** If the area of the triangle formed by the vertices  $A(-1, 2)$ ,  $B(k, -2)$  and  $C(7, 4)$  (taken in order) is 22 sq. units, find the value of  $k$ .



**Solution** The vertices are  $A(-1,2)$ ,  $B(k,-2)$  and  $C(7,4)$

Area of triangle  $ABC$  is 22 sq.units

$$\frac{1}{2} \{ (x_1y_2 + x_2y_3 + x_3y_1) - (x_2y_1 + x_3y_2 + x_1y_3) \} = 22$$

$$\frac{1}{2} \{ (2 + 4k + 14) - (2k - 14 - 4) \} = 22$$

$$2k + 34 = 44 \text{ gives } 2k = 10 \text{ so } k = 5$$

**Example 5.4** If the points  $P(-1,-4)$ ,  $Q(b,c)$  and  $R(5,-1)$  are collinear and if  $2b + c = 4$ , then find the values of  $b$  and  $c$ .

**Solution** Since the three points  $P(-1,-4)$ ,  $Q(b,c)$  and  $R(5,-1)$  are collinear,

$$\text{Area of triangle } PQR = 0$$

$$\frac{1}{2} \{ (x_1y_2 + x_2y_3 + x_3y_1) - (x_2y_1 + x_3y_2 + x_1y_3) \} = 0$$

$$\frac{1}{2} \{ (-c - b - 20) - (-4b + 5c + 1) \} = 0$$

$$-c - b - 20 + 4b - 5c - 1 = 0$$

$$b - 2c = 7 \quad \dots(1)$$

$$\text{Also, } 2b + c = 4 \quad \dots(2) \text{ (from given information)}$$

Solving (1) and (2) we get  $b = 3$ ,  $c = -2$

**Example 5.5** The floor of a hall is covered with identical tiles which are in the shapes of triangles. One such triangle has the vertices at  $(-3,2)$ ,  $(-1,-1)$  and  $(1,2)$ . If the floor of the hall is completely covered by 110 tiles, find the area of the floor.

**Solution** Vertices of one triangular tile are at

$$(-3,2), (-1,-1) \text{ and } (1,2)$$

$$\text{Area of this tile} = \frac{1}{2} \{ (3 - 2 + 2) - (-2 - 1 - 6) \} \text{ sq.units}$$

$$= \frac{1}{2} (12) = 6 \text{ sq.units}$$

Since the floor is covered by 110 triangle shaped identical tiles,

$$\text{Area of floor} = 110 \times 6 = 660 \text{ sq.units}$$

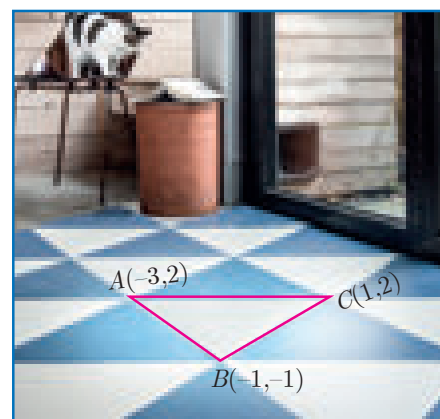

Fig. 5.11

**Example 5.6** Find the area of the quadrilateral formed by the points  $(8,6)$ ,  $(5,11)$ ,  $(-5,12)$  and  $(-4,3)$ .

**Solution** Before determining the area of quadrilateral, plot the vertices in a graph.

$$\text{Let the vertices be } A(8,6), B(5,11), C(-5,12) \text{ and } D(-4,3)$$

Therefore, area of the quadrilateral  $ABCD$

$$\begin{aligned}
 &= \frac{1}{2} \{ (x_1y_2 + x_2y_3 + x_3y_4 + x_4y_1) - (x_2y_1 + x_3y_2 + x_4y_3 + x_1y_4) \} \\
 &= \frac{1}{2} \{ (88 + 60 - 15 - 24) - (30 - 55 - 48 + 24) \} \\
 &= \frac{1}{2} \{ 109 + 49 \} \\
 &= \frac{1}{2} \{ 158 \} = 79 \text{ sq.units}
 \end{aligned}$$

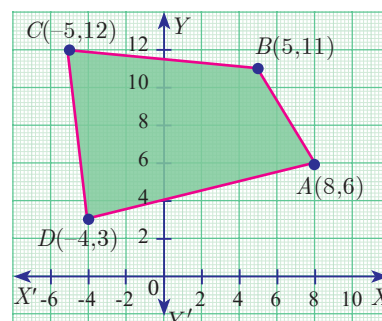

Fig. 5.12



### Progress Check

Given a quadrilateral  $ABCD$  with vertices  $A(-3, -8)$ ,  $B(6, -6)$ ,  $C(4, 2)$ ,  $D(-8, 2)$

1. Find the area of  $\triangle ABC$ .
2. Find the area of  $\triangle ACD$ .
3. Calculate area of  $\triangle ABC$  + area of  $\triangle ACD$ .
4. Find the area of quadrilateral  $ABCD$ .
5. Compare the answers obtained in 3 and 4.

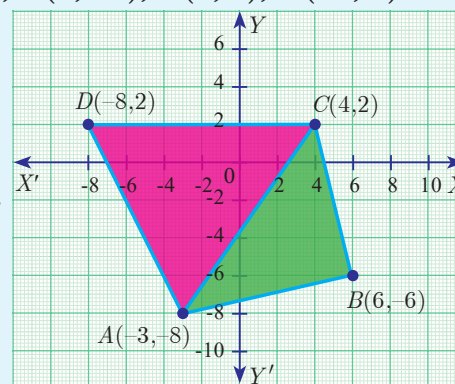

Fig. 5.13

**Example 5.7** The given diagram shows a plan for constructing a new parking lot at a campus. It is estimated that such construction would cost ₹1300 per square feet. What will be the total cost for making the parking lot?

**Solution** The parking lot is a quadrilateral whose vertices are at  $A(2,2)$ ,  $B(5,5)$ ,  $C(4,9)$  and  $D(1,7)$ .

$$\begin{aligned}
 \text{Area of parking lot} &= \frac{1}{2} \left| \begin{array}{cccc} 2 & 5 & 4 & 1 \\ 2 & 5 & 9 & 7 \\ 2 & 2 & 2 & 2 \end{array} \right| \text{sq.units} \\
 &= \frac{1}{2} \{ (10 + 45 + 28 + 2) - (10 + 20 + 9 + 14) \} \\
 &= \frac{1}{2} \{ 85 - 53 \} \\
 &= \frac{1}{2} (32) = 16 \text{ sq.units.}
 \end{aligned}$$

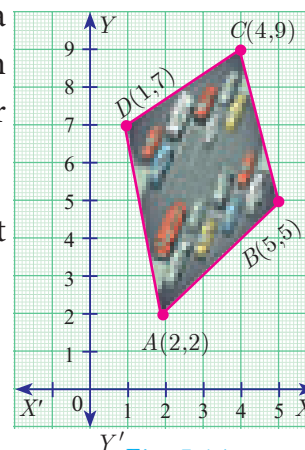

Fig. 5.14

Area of parking lot	= 16 sq.feet
Construction rate per square feet	= ₹1300
Total cost for constructing the parking lot	= $16 \times 1300 = ₹20800$







### Activity 1

- (i) Take a graph sheet.
- (ii) Consider a triangle whose base is the line joining the points (0,0) and (6,0)
- (iii) Take the third vertex as (1,1), (2,2), (3,3), (4,4), (5,5) and find their areas. Fill in the details given.
- (iv) Do you see any pattern with  $A_1, A_2, A_3, A_4, A_5$ ? If so mention it.
- (v) Repeat the same process by taking third vertex in step (iii) as (1,2), (2,4), (3,8), (4,16), (5,32).
- (vi) Fill the table with these new vertices.
- (vii) What pattern do you observe now with  $A_1, A_2, A_3, A_4, A_5$ ?

Third vertex	Area of Triangle
(1,1)	$A_1 =$
(2,2)	$A_2 =$
(3,3)	$A_3 =$
(4,4)	$A_4 =$
(5,5)	$A_5 =$

Third vertex	Area of Triangle
(1,2)	$A_1 =$
(2,4)	$A_2 =$
(3,8)	$A_3 =$
(4,16)	$A_4 =$
(5,32)	$A_5 =$



### Activity 2

Find the area of the shaded region

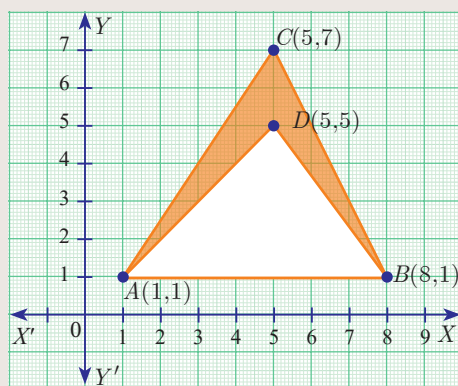

Fig. 5.15



Two French mathematicians Rene Descartes and Pierre-de-Fermat were the first to conceive the idea of modern coordinate geometry by 1630s.



### Exercise 5.1

1. Find the area of the triangle formed by the points
  - (i) (1,-1), (-4, 6) and (-3, -5)
  - (ii) (-10, -4), (-8, -1) and (-3, -5)
2. Determine whether the sets of points are collinear?
  - (i)  $(-\frac{1}{2}, 3)$ , (-5, 6) and (-8, 8)
  - (ii)  $(a, b+c)$ ,  $(b, c+a)$  and  $(c, a+b)$
3. Vertices of given triangles are taken in order and their areas are provided aside. In each case, find the value of 'p'.

S.No.	Vertices	Area (sq.units)
(i)	(0, 0), (p, 8), (6, 2)	20
(ii)	(p, p), (5, 6), (5, -2)	32

4. In each of the following, find the value of 'a' for which the given points are collinear.
  - (i) (2, 3), (4, a) and (6, -3)
  - (ii) (a, 2-2a), (-a+1, 2a) and (-4-a, 6-2a)
5. Find the area of the quadrilateral whose vertices are at
  - (i) (-9, -2), (-8, -4), (2, 2) and (1, -3)
  - (ii) (-9, 0), (-8, 6), (-1, -2) and (-6, -3)
6. Find the value of k, if the area of a quadrilateral is 28 sq.units, whose vertices are taken in the order (-4, -2), (-3, k), (3, -2) and (2, 3)
7. If the points A(-3,9), B(a,b) and C(4,-5) are collinear and if  $a + b = 1$ , then find a and b.
8. Let P(11,7), Q(13.5,4) and R(9.5,4) be the mid-points of the sides AB, BC and AC respectively of  $\Delta ABC$ . Find the coordinates of the vertices A, B and C. Hence find the area of  $\Delta ABC$  and compare this with area of  $\Delta PQR$ .

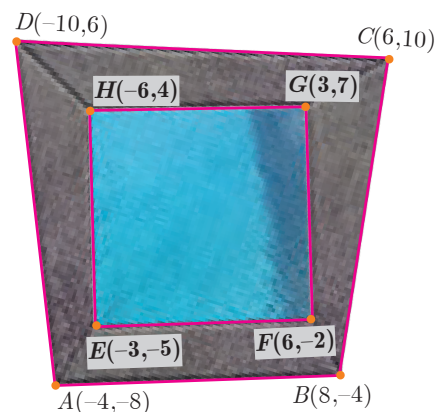

9. In the figure, the quadrilateral swimming pool shown is surrounded by concrete patio. Find the area of the patio.
10. A triangular shaped glass with vertices at A(-5,-4), B(1,6) and C(7,-4) has to be painted. If one bucket of paint covers 6 square feet, how many buckets of paint will be required to paint the whole glass, if only one coat of paint is applied.

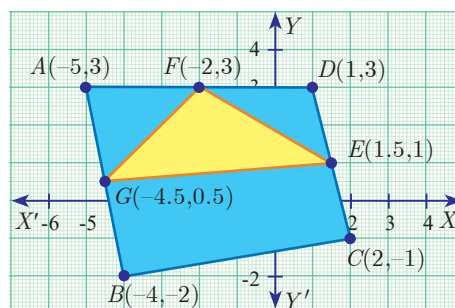

11. In the figure, find the area of (i) triangle AGF (ii) triangle FED (iii) quadrilateral BCEG.

### 5.4 Inclination of a Line

The inclination of a line or the **angle of inclination** of a line is the angle which a straight line makes with the positive direction of X axis measured in the counter-clockwise direction to the part of the line above the X axis. The inclination of the line is usually denoted by  $\theta$ .

**Note**

- The inclination of X axis and every line parallel to X axis is  $0^\circ$ .
- The inclination of Y axis and every line parallel to Y axis is  $90^\circ$ .

#### 5.4.1 Slope of a Straight line

While laying roads one must know how steep the road will be. Similarly, when constructing a staircase, we should consider its steepness. For the same reason, anyone travelling along a hill or a bridge, feels hard compared to travelling along a plain road.





All these examples illustrate one important aspect called “Steepness”. The measure of steepness is called **slope** or **gradient**.

The concept of slope is important in economics because it is used to measure the rate at which the demand for a product changes in a given period of time on the basis of its price. Slope comprises of two factors namely steepness and direction.



Fig. 5.16

**Definition**

If  $\theta$  is the angle of inclination of a non-vertical straight line, then  $\tan \theta$  is called the slope or gradient of the line and is denoted by  $m$ .

Therefore the slope of the straight line is  $m = \tan \theta$ ,  $0 \leq \theta \leq 180^\circ$ ,  $\theta \neq 90^\circ$

**To find the slope of a straight line when two points are given**

$$\begin{aligned} \text{Slope } m &= \tan \theta \\ &= \frac{\text{opposite side}}{\text{adjacent side}} \\ &= \frac{BC}{AC} \\ m &= \frac{y_2 - y_1}{x_2 - x_1} \end{aligned}$$

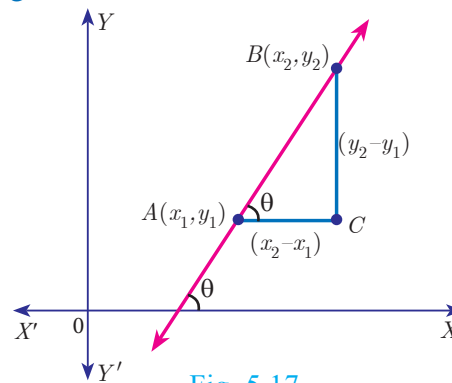

Fig. 5.17

$$\text{Slope } m = \frac{\text{Difference in } y \text{ coordinates}}{\text{Difference in } x \text{ coordinates}}$$

**Note**  
The slope of a vertical line is undefined.

The slope of the line through  $(x_1, y_1)$  and  $(x_2, y_2)$  with  $x_1 \neq x_2$  is  $\frac{y_2 - y_1}{x_2 - x_1}$ .

**Values of slopes**

S. No.	Condition	Slope	Diagram
(i)	$\theta = 0^\circ$	The line is parallel to the positive direction of X axis.	

Fig. 5.18(a)

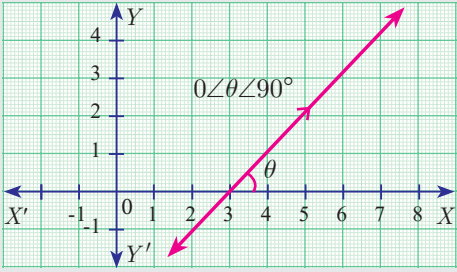
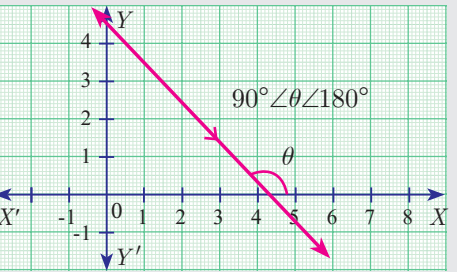
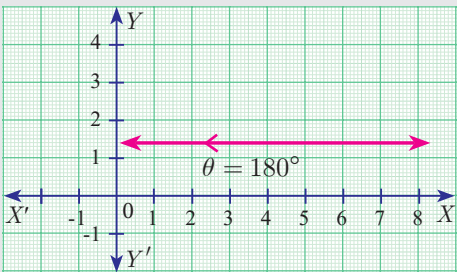
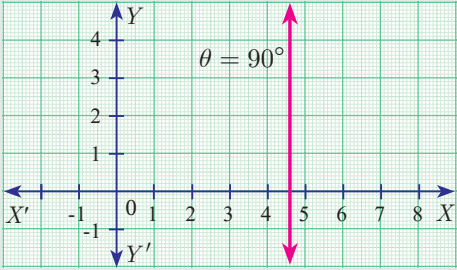
(ii)	$0 < \theta < 90^\circ$	The line has positive slope (A line with positive slope rises from left to right).	 <p>Fig. 5.18(b)</p>
(iii)	$90^\circ < \theta < 180^\circ$	The line has negative slope (A line with negative slope falls from left to right).	 <p>Fig. 5.18(c)</p>
(iv)	$\theta = 180^\circ$	The line is parallel to the negative direction of X axis.	 <p>Fig. 5.18(d)</p>
(v)	$\theta = 90^\circ$	The slope is undefined.	 <p>Fig. 5.18(e)</p>



### Activity 3

The diagram contain four lines  $l_1$ ,  $l_2$ ,  $l_3$  and  $l_4$ .

- Which lines have positive slope?
- Which lines have negative slope?

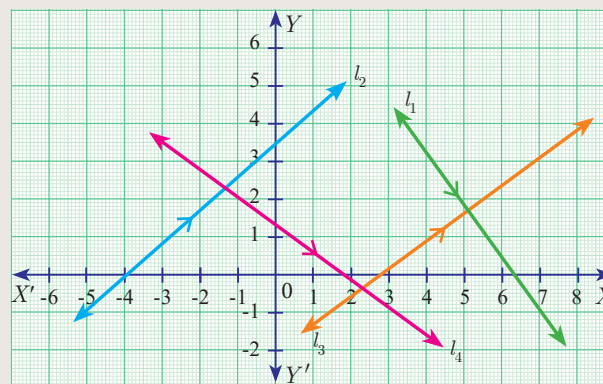

Fig. 5.19



**Progress Check**

Write down the slope of each of the lines shown on the grid below. One is solved for you.

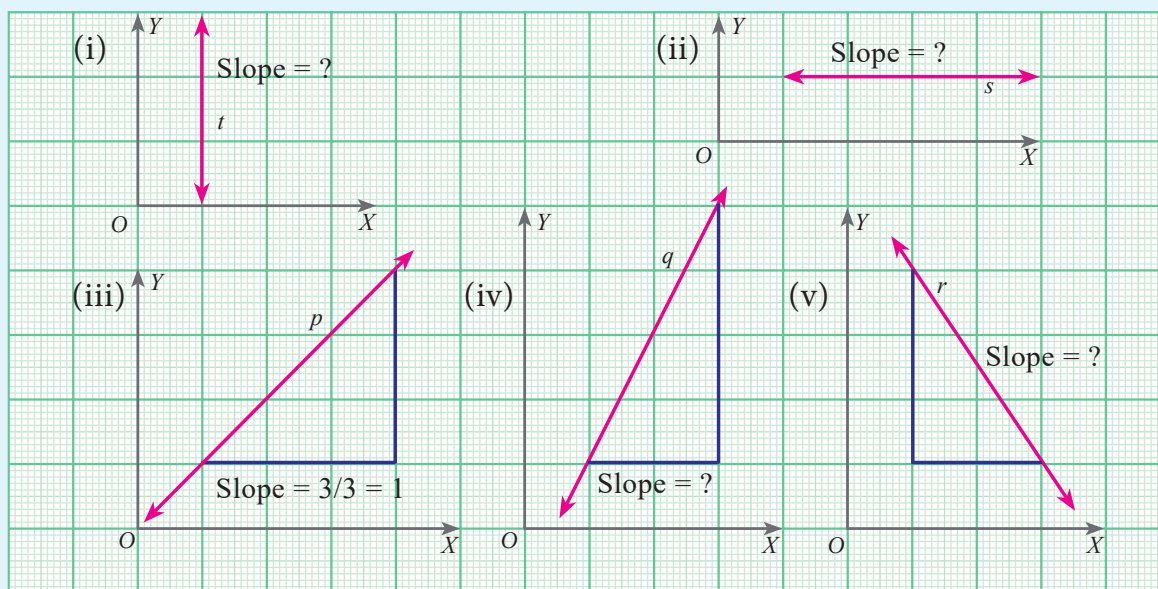

Fig. 5.20

**Solution** (iii) Slope of the line  $p = \frac{\text{Difference in } y \text{ coordinate}}{\text{Difference in } x \text{ coordinate}} = \frac{3}{3} = 1$

**5.4.2 Slopes of parallel lines**

Two non-vertical lines are **parallel** if and only if their **slopes are equal**.

Let  $l_1$  and  $l_2$  be two non-vertical lines with slopes  $m_1$  and  $m_2$  respectively.

Let the inclination of the lines with positive direction of  $X$  axis be  $\theta_1$  and  $\theta_2$  respectively.

Assume,  $l_1$  and  $l_2$  are parallel

$$\theta_1 = \theta_2 \text{ (Since, } \theta_1, \theta_2 \text{ are corresponding angles)}$$

$$\tan \theta_1 = \tan \theta_2$$

$$m_1 = m_2$$

Hence, the slopes are equal.

Therefore, non-vertical parallel lines have equal slopes.

**Conversely**

Let the slopes be equal, then  $m_1 = m_2$

$$\tan \theta_1 = \tan \theta_2$$

$$\theta_1 = \theta_2 \text{ (since } 0 \leq \theta_1 \leq 180^\circ, 0 \leq \theta_2 \leq 180^\circ)$$

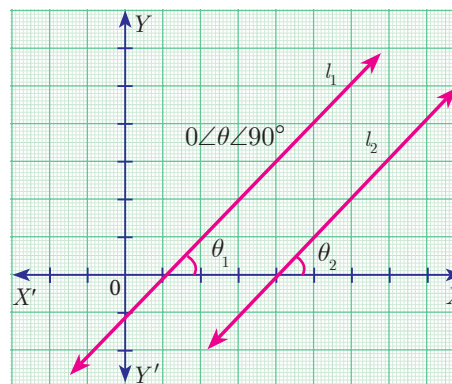

Fig. 5.21



That is the corresponding angles are equal.

Therefore,  $l_1$  and  $l_2$  are parallel.

Thus, non-vertical lines having equal slopes are parallel.

Hence, **non vertical lines** are **parallel** if and only if their **slopes are equal**.

### 5.4.3 Slopes of perpendicular lines

Two non-vertical lines with slopes  $m_1$  and  $m_2$  are **perpendicular** if and only if  $m_1 m_2 = -1$ .

Let  $l_1$  and  $l_2$  be two non-vertical lines with slopes  $m_1$  and  $m_2$ , respectively. Let their inclinations be  $\theta_1$  and  $\theta_2$  respectively.

Then  $m_1 = \tan \theta_1$  and  $m_2 = \tan \theta_2$

First we assume that,  $l_1$  and  $l_2$  are perpendicular to each other.

Then  $\angle ABC = 90^\circ - \theta_1$  (sum of angles of  $\triangle ABC$  is  $180^\circ$ )

Now measuring slope of  $l_2$  through angles  $\theta_2$  and  $90^\circ - \theta_1$ , which are opposite to each other, we get

$$\begin{aligned} \tan \theta_2 &= -\tan(90^\circ - \theta_1) \\ &= \frac{-\sin(90^\circ - \theta_1)}{\cos(90^\circ - \theta_1)} = \frac{-\cos \theta_1}{\sin \theta_1} = -\cot \theta_1 \quad \text{gives, } \tan \theta_2 = -\frac{1}{\tan \theta_1} \end{aligned}$$

$$\tan \theta_1 \cdot \tan \theta_2 = -1$$

$$m_1 \cdot m_2 = -1.$$

Thus, when the line  $l_1$  is perpendicular to line  $l_2$  then  $m_1 m_2 = -1$ .

#### Conversely,

Let  $l_1$  and  $l_2$  be two non-vertical lines with slopes  $m_1$  and  $m_2$  respectively, such that  $m_1 m_2 = -1$ .

Since  $m_1 = \tan \theta_1$ ,  $m_2 = \tan \theta_2$

We have  $\tan \theta_1 \tan \theta_2 = -1$

$$\tan \theta_1 = -\frac{1}{\tan \theta_2}$$

$$\tan \theta_1 = -\cot \theta_2$$

$$\tan \theta_1 = -\tan(90^\circ - \theta_2)$$

$$\tan \theta_1 = \tan(-90^\circ - \theta_2) = \tan(\theta_2 - 90^\circ)$$

$$\theta_1 = \theta_2 - 90^\circ \quad (\text{since } 0 \leq \theta_1 \leq 180^\circ, 0 \leq \theta_2 \leq 180^\circ)$$

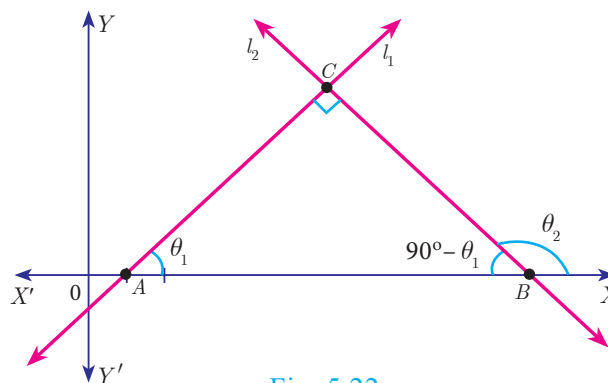

Fig. 5.22



$$\theta_2 = 90^\circ + \theta_1$$

But in  $\triangle ABC$ ,  $\theta_2 = \angle C + \theta_1$   
Therefore,  $\angle C = 90^\circ$

**Note**

Let  $l_1$  and  $l_2$  be two lines with well-defined slopes  $m_1$  and  $m_2$  respectively, then

- (i)  $l_1$  is parallel to  $l_2$  if and only if  $m_1 = m_2$ .  
(ii)  $l_1$  is perpendicular to  $l_2$  if and only if  $m_1 m_2 = -1$ .



In any triangle, exterior angle is equal to sum of the interior opposite angles.

- Example 5.8** (i) What is the slope of a line whose inclination is  $30^\circ$ ?  
(ii) What is the inclination of a line whose slope is  $\sqrt{3}$ ?

**Solution** (i) Here  $\theta = 30^\circ$   
Slope  $m = \tan \theta$

$$\text{Therefore, slope } m = \tan 30^\circ = \frac{1}{\sqrt{3}}$$

- (ii) Given  $m = \sqrt{3}$ , let  $\theta$  be the inclination of the line

$$\tan \theta = \sqrt{3}$$

$$\text{We get, } \theta = 60^\circ$$

**Thinking Corner**

The straight lines  $X$  axis and  $Y$  axis are perpendicular to each other. Is the condition  $m_1 m_2 = -1$  true?

**Example 5.9** Find the slope of a line joining the given points

- (i)  $(-6, 1)$  and  $(-3, 2)$       (ii)  $\left(-\frac{1}{3}, \frac{1}{2}\right)$  and  $\left(\frac{2}{7}, \frac{3}{7}\right)$       (iii)  $(14, 10)$  and  $(14, -6)$

**Solution**

- (i)  $(-6, 1)$  and  $(-3, 2)$

$$\text{The slope} = \frac{y_2 - y_1}{x_2 - x_1} = \frac{2 - 1}{-3 - (-6)} = \frac{1}{3}$$

- (ii)  $\left(-\frac{1}{3}, \frac{1}{2}\right)$  and  $\left(\frac{2}{7}, \frac{3}{7}\right)$

$$\begin{aligned} \text{The slope} &= \frac{\frac{3}{7} - \frac{1}{2}}{\frac{2}{7} - \left(-\frac{1}{3}\right)} = \frac{\frac{6 - 7}{14}}{\frac{6 + 7}{21}} \\ &= -\frac{1}{14} \times \frac{21}{13} = -\frac{3}{26} \end{aligned}$$

- (iii)  $(14, 10)$  and  $(14, -6)$

$$\text{The slope} = \frac{-6 - 10}{14 - 14} = \frac{-16}{0}$$

The slope is undefined.

**Progress Check**

Fill in the missing boxes

S.No.	Points	Slope
1	$A(-a, b), B(3a, -b)$	
2	$A(2, 3), B(, )$	2
3	$A(, ), B(, )$	0
4	$A(, ), B(, )$	undefined

**Example 5.10** The line  $r$  passes through the points  $(-2, 2)$  and  $(5, 8)$  and the line  $s$  passes through the points  $(-8, 7)$  and  $(-2, 0)$ . Is the line  $r$  perpendicular to  $s$ ?

**Solution** The slope of line  $r$  is  $m_1 = \frac{8-2}{5-(-2)} = \frac{6}{7}$

The slope of line  $s$  is  $m_2 = \frac{0-7}{-2+8} = \frac{-7}{6}$

The product of slopes  $= \frac{6}{7} \times \frac{-7}{6} = -1$

That is,  $m_1 m_2 = -1$

Therefore, the line  $r$  is perpendicular to line  $s$ .

**Example 5.11** The line  $p$  passes through the points  $(3, -2)$ ,  $(12, 4)$  and the line  $q$  passes through the points  $(6, -2)$  and  $(12, 2)$ . Is  $p$  parallel to  $q$ ?

**Solution** The slope of line  $p$  is  $m_1 = \frac{4+2}{12-3} = \frac{6}{9} = \frac{2}{3}$

The slope of line  $q$  is  $m_2 = \frac{2+2}{12-6} = \frac{4}{6} = \frac{2}{3}$

Thus, slope of line  $p$  = slope of line  $q$ .

Therefore, line  $p$  is parallel to the line  $q$ .

**Example 5.12** Show that the points  $(-2, 5)$ ,  $(6, -1)$  and  $(2, 2)$  are collinear.

**Solution** The vertices are  $A(-2, 5)$ ,  $B(6, -1)$  and  $C(2, 2)$ .

Slope of  $AB = \frac{-1-5}{6+2} = \frac{-6}{8} = \frac{-3}{4}$

Slope of  $BC = \frac{2+1}{2-6} = \frac{3}{-4} = \frac{-3}{4}$

We get, Slope of  $AB$  = Slope of  $BC$

Therefore, the points  $A$ ,  $B$ ,  $C$  all lie in a same straight line.

Hence the points  $A$ ,  $B$  and  $C$  are collinear.

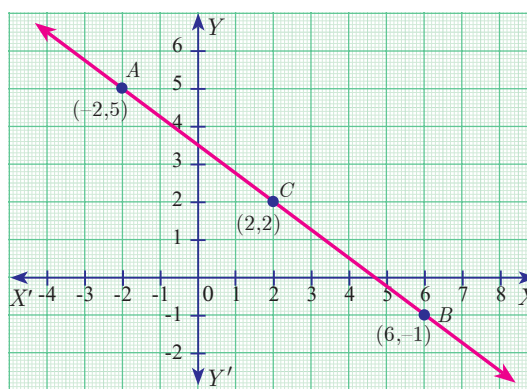

Fig. 5.23

**Example 5.13** Let  $A(1, -2)$ ,  $B(6, -2)$ ,  $C(5, 1)$  and  $D(2, 1)$  be four points

- Find the slope of the line segments (a)  $AB$  (b)  $CD$
- Find the slope of the line segments (a)  $BC$  (b)  $AD$
- What can you deduce from your answer.

**Solution** (i) (a) Slope of  $AB = \frac{y_2 - y_1}{x_2 - x_1} = \frac{-2+2}{6-1} = 0$

(b) Slope of  $CD = \frac{1-1}{2-5} = \frac{0}{-3} = 0$



If the slopes of both the pairs of opposite sides are equal then the quadrilateral is a parallelogram.



$$(ii) (a) \text{ Slope of } BC = \frac{1+2}{5-6} = \frac{3}{-1} = -3$$

$$(b) \text{ Slope of } AD = \frac{1+2}{2-1} = \frac{3}{1} = 3$$

(iii) The slope of AB and CD are equal so AB, CD are parallel.

Similarly the lines AD and BC are not parallel, since their slopes are not equal. So, we can deduce that the quadrilateral ABCD is a trapezium.

**Example 5.14** Consider the graph representing growth of population (in crores). Find the slope of the line AB and hence estimate the population in the year 2030?

**Solution** The points  $A(2005, 96)$  and  $B(2015, 100)$  are on the line AB.

$$\text{Slope of AB} = \frac{100 - 96}{2015 - 2005} = \frac{4}{10} = \frac{2}{5}$$

Let the growth of population in 2030 be  $k$  crores.

Assuming that the point  $C(2030, k)$  is on AB,

we have, slope of AC = slope of AB

$$\frac{k - 96}{2030 - 2005} = \frac{2}{5} \quad \text{gives} \quad \frac{k - 96}{25} = \frac{2}{5}$$

$$k - 96 = 10$$

$$k = 106$$

Hence the estimated population in 2030 = 106 Crores.

**Example 5.15** Without using Pythagoras theorem, show that the points  $(1, -4)$ ,  $(2, -3)$  and  $(4, -7)$  form a right angled triangle.

**Solution** Let the given points be  $A(1, -4)$ ,  $B(2, -3)$  and  $C(4, -7)$ .

$$\text{The slope of AB} = \frac{-3 + 4}{2 - 1} = \frac{1}{1} = 1$$

$$\text{The slope of BC} = \frac{-7 + 3}{4 - 2} = \frac{-4}{2} = -2$$

$$\text{The slope of AC} = \frac{-7 + 4}{4 - 1} = \frac{-3}{3} = -1$$

$$\text{Slope of AB} \times \text{slope of AC} = (1)(-1) = -1$$

AB is perpendicular to AC.  $\angle A = 90^\circ$

Therefore,  $\triangle ABC$  is a right angled triangle.

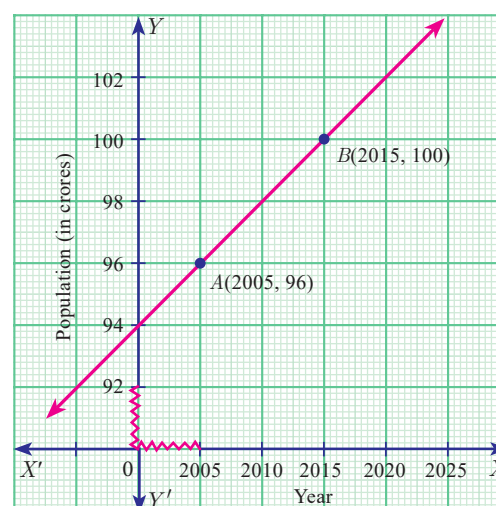

Fig. 5.24

### Thinking Corner



Provide three examples of using the concept of slope in real-life situations.

**Example 5.16** Prove analytically that the line segment joining the mid-points of two sides of a triangle is parallel to the third side and is equal to half of its length.

**Solution** Let  $P(a, b)$ ,  $Q(c, d)$  and  $R(e, f)$  be the vertices of a triangle.

Let  $S$  be the mid-point of  $PQ$  and  $T$  be the mid-point of  $PR$

$$\text{Therefore, } S = \left( \frac{a+c}{2}, \frac{b+d}{2} \right) \text{ and } T = \left( \frac{a+e}{2}, \frac{b+f}{2} \right)$$

$$\text{Now, slope of } ST = \frac{\frac{b+f}{2} - \frac{b+d}{2}}{\frac{a+e}{2} - \frac{a+c}{2}} = \frac{f-d}{e-c}$$

$$\text{And slope of } QR = \frac{f-d}{e-c}$$

Therefore,  $ST$  is parallel to  $QR$ . (since, their slopes are equal)

$$\begin{aligned} \text{Also } ST &= \sqrt{\left( \frac{a+e}{2} - \frac{a+c}{2} \right)^2 + \left( \frac{b+f}{2} - \frac{b+d}{2} \right)^2} \\ &= \frac{1}{2} \sqrt{(e-c)^2 + (f-d)^2} \end{aligned}$$

$$ST = \frac{1}{2} QR$$

Thus  $ST$  is parallel to  $QR$  and half of it.

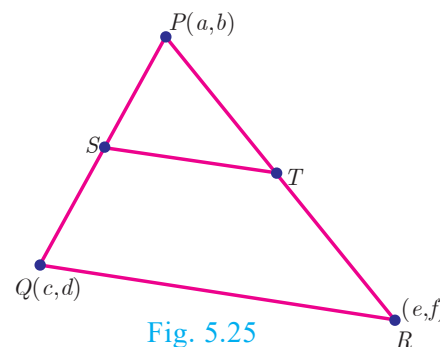

Fig. 5.25

### Note

This example illustrates how a geometrical result can be proved using coordinate Geometry.



### Exercise 5.2

- What is the slope of a line whose inclination with positive direction of  $x$ -axis is  
(i)  $90^\circ$                       (ii)  $0^\circ$
- What is the inclination of a line whose slope is    (i) 0    (ii) 1
- Find the slope of a line joining the points  
(i)  $(5, \sqrt{5})$  with the origin                      (ii)  $(\sin \theta, -\cos \theta)$  and  $(-\sin \theta, \cos \theta)$
- What is the slope of a line perpendicular to the line joining  $A(5,1)$  and  $P$  where  $P$  is the mid-point of the segment joining  $(4,2)$  and  $(-6,4)$ .
- Show that the given points are collinear:  $(-3, -4)$ ,  $(7,2)$  and  $(12,5)$
- If the three points  $(3, -1)$ ,  $(a, 3)$  and  $(1, -3)$  are collinear, find the value of  $a$ .
- The line through the points  $(-2, a)$  and  $(9, 3)$  has slope  $-\frac{1}{2}$ . Find the value of  $a$ .
- The line through the points  $(-2, 6)$  and  $(4, 8)$  is perpendicular to the line through the points  $(8, 12)$  and  $(x, 24)$ . Find the value of  $x$ .
- Show that the given points form a right angled triangle and check whether they satisfies pythagoras theorem  
(i)  $A(1, -4)$ ,  $B(2, -3)$  and  $C(4, -7)$     (ii)  $L(0, 5)$ ,  $M(9, 12)$  and  $N(3, 14)$

10. Show that the given points form a parallelogram :

$$A(2.5, 3.5), B(10, -4), C(2.5, -2.5) \text{ and } D(-5, 5)$$

11. If the points  $A(2, 2), B(-2, -3), C(1, -3)$  and  $D(x, y)$  form a parallelogram then find the value of  $x$  and  $y$ .

12. Let  $A(3, -4), B(9, -4), C(5, -7)$  and  $D(7, -7)$ . Show that  $ABCD$  is a trapezium.

13. A quadrilateral has vertices at  $A(-4, -2), B(5, -1), C(6, 5)$  and  $D(-7, 6)$ . Show that the mid-points of its sides form a parallelogram.

## 5.5 Straight Line

Any **first degree equation** in two variables  $x$  and  $y$  of the form  $ax + by + c = 0 \dots(1)$  where  $a, b, c$  are real numbers and at least one of  $a, b$  is non-zero is called "Straight line" in  $XY$  plane.

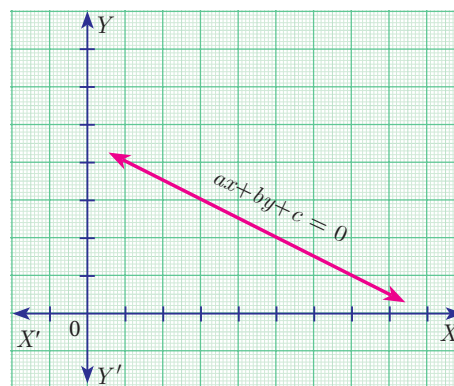

Fig. 5.26

### 5.5.1 Equation of coordinate axes

The  $X$  axis and  $Y$  axis together are called coordinate axes. The  $x$  coordinate of every point on  $OY$  ( $Y$  axis) is 0. Therefore **equation of  $OY$**  ( $Y$  axis) is  $x = 0$  (fig 5.27)

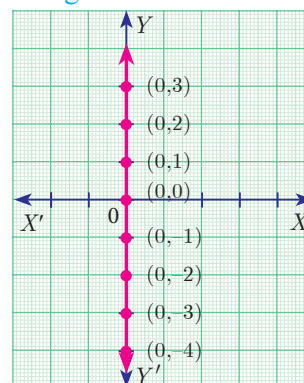

Fig. 5.27

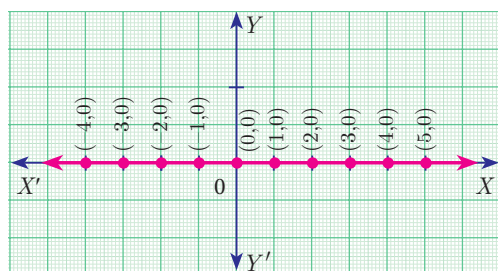

Fig. 5.28

The  $y$  coordinate of every point on  $OX$  ( $X$  axis) is 0. Therefore the **equation of  $OX$**  ( $X$  axis) is  $y = 0$  (fig 5.28)

### 5.5.2 Equation of a straight line parallel to $X$ axis

Let  $AB$  be a straight line **parallel to  $X$  axis**, which is at a **distance 'b'**. Then  $y$  coordinate of every point on ' $AB$ ' is ' $b$ '. (fig 5.29)

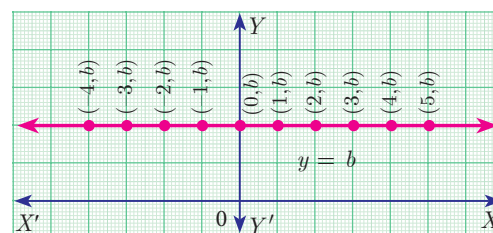

Fig. 5.29

Therefore, the equation of  $AB$  is  $y = b$

#### Note

- If  $b > 0$ , then the line  $y=b$  lies above the  $X$  axis
- If  $b < 0$ , then the line  $y=b$  lies below the  $X$  axis
- If  $b = 0$ , then the line  $y=b$  is the  $X$  axis itself.

### 5.5.3 Equation of a Straight line parallel to the $Y$ axis

Let  $CD$  be a straight line parallel to  $Y$  axis, which is at a distance ' $c$ '. Then  $x$  coordinate of every point on  $CD$  is ' $c$ '. The equation of  $CD$  is  $x = c$ . (fig 5.30)

#### Note

- If  $c > 0$ , then the line  $x=c$  lies right to the side of the  $Y$  axis
- If  $c < 0$ , then the line  $x=c$  lies left to the side of the  $Y$  axis
- If  $c = 0$ , then the line  $x=c$  is the  $Y$  axis itself.

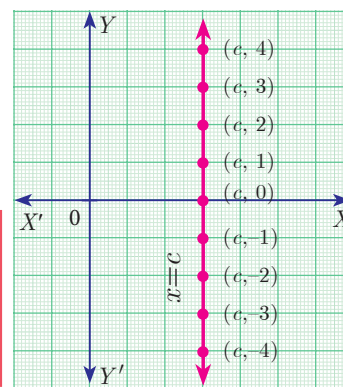

Fig. 5.30

**Example 5.17** Find the equation of a straight line passing through  $(5,7)$  and is (i) parallel to  $X$  axis (ii) parallel to  $Y$  axis.

**Solution** (i) The equation of any straight line parallel to  $X$  axis is  $y=b$ .

Since it passes through  $(5,7)$ ,  $b = 7$ .

Therefore, the required equation of the line is  $y=7$ .

(ii) The equation of any straight line parallel to  $Y$  axis is  $x=c$

Since it passes through  $(5,7)$ ,  $c = 5$

Therefore, the required equation of the line is  $x=5$ .

### 5.5.4 Slope-Intercept Form

Every straight line that is not vertical will cut the  $Y$  axis at a single point. The  $y$  coordinate of this point is called  $y$  intercept of the line.

A line with slope  $m$  and  $y$  intercept  $c$  can be expressed through the equation  $y=mx+c$

We call this equation as the **slope-intercept form** of the equation of a line.

DO  
YOU  
KNOW?

- If a line with slope  $m$ ,  $m \neq 0$  makes  $x$  intercept  $d$ , then the equation of the straight line is  $y = m(x-d)$ .
- $y = mx$  represent equation of a straight line with slope  $m$  and passing through the origin.

**Example 5.18** Find the equation of a straight line whose

(i) Slope is 5 and  $y$  intercept is  $-9$  (ii) Inclination is  $45^\circ$  and  $y$  intercept is 11

**Solution** (i) Given, Slope = 5,  $y$  intercept,  $c = -9$

Therefore, equation of a straight line is  $y = mx + c$

$$y = 5x - 9 \Rightarrow 5x - y - 9 = 0$$

(ii) Given,  $\theta = 45^\circ$ ,  $y$  intercept,  $c = 11$

$$\text{Slope } m = \tan \theta = \tan 45^\circ = 1$$

Therefore, equation of a straight line is of the form  $y = mx + c$

$$\text{Hence we get, } y = x + 11 \Rightarrow x - y + 11 = 0$$

**Example 5.19** Calculate the slope and  $y$  intercept of the straight line  $8x - 7y + 6 = 0$

**Solution** Equation of the given straight line is  $8x - 7y + 6 = 0$

$$7y = 8x + 6 \quad (\text{bringing it to the form } y = mx + c)$$

$$y = \frac{8}{7}x + \frac{6}{7} \quad \dots(1)$$

Comparing (1) with  $y = mx + c$

$$\text{Slope } m = \frac{8}{7} \text{ and } y \text{ intercept } c = \frac{6}{7}$$

**DO YOU KNOW?**

For, the point  $(x, y)$  in a  $xy$  plane, the  $x$  coordinate  $x$  is called "Abscissae" and the  $y$  coordinate  $y$  is called "Ordinate".

**Example 5.20** The graph relates temperatures  $y$  (in Fahrenheit degree) to temperatures  $x$  (in Celsius degree) (a) Find the slope and  $y$  intercept (b) Write an equation of the line (c) What is the mean temperature of the earth in Fahrenheit degree if its mean temperature is  $25^\circ$  Celsius?

**Solution** (a) From the figure, slope =  $\frac{\text{change in } y \text{ coordinate}}{\text{change in } x \text{ coordinate}} = \frac{68 - 32}{20 - 0} = \frac{36}{20} = \frac{9}{5} = 1.8$

The line crosses the  $Y$  axis at  $(0, 32)$

So the slope is  $\frac{9}{5}$  and  $y$  intercept is 32.

(b) Use the slope and  $y$  intercept to write an equation

$$\text{The equation is } y = \frac{9}{5}x + 32$$

(c) In Celsius, the mean temperature of the earth is  $25^\circ$ . To find the mean temperature in Fahrenheit, we find the value of  $y$  when  $x = 25$

$$y = \frac{9}{5}x + 32$$

$$y = \frac{9}{5}(25) + 32$$

$$y = 77$$

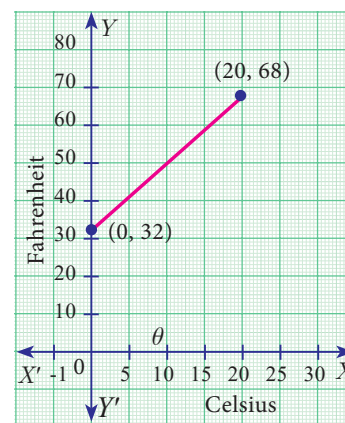

Fig. 5.31

**Note**

The formula for converting Celsius to Fahrenheit is given by  $F = \frac{9}{5}C + 32$ , which is the linear equation representing a straight line derived in the example.

Therefore, the mean temperature of the earth is  $77^\circ$  F.

**5.5.5 Point-Slope form**

Here we will find the equation of a straight line passing through a given point  $A(x_1, y_1)$  and having the slope  $m$ .

Let  $P(x, y)$  be any point other than  $A$  on the given line. Slope of the line joining  $A(x_1, y_1)$  and  $P(x, y)$  is given by

$$m = \tan \theta = \frac{y - y_1}{x - x_1}$$

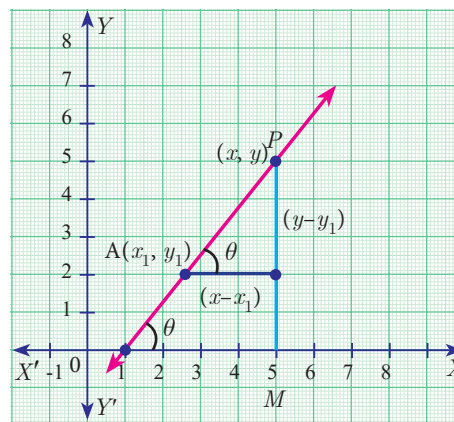

Fig. 5.32

Therefore, the **equation** of the required **line** is  $y - y_1 = m(x - x_1)$  (**Point slope form**)

**Example 5.21** Find the equation of a line passing through the point  $(3, -4)$  and having slope  $\frac{-5}{7}$

**Solution** Given,  $(x_1, y_1) = (3, -4)$  and  $m = \frac{-5}{7}$

The equation of the point-slope form of the straight line is  $y - y_1 = m(x - x_1)$

we write it as  $y + 4 = -\frac{5}{7}(x - 3)$

$$\Rightarrow 5x + 7y + 13 = 0$$

**Example 5.22** Find the equation of a line passing through the point  $A(1, 4)$  and perpendicular to the line joining points  $(2, 5)$  and  $(4, 7)$ .

**Solution**

Let the given points be  $A(1, 4)$ ,  $B(2, 5)$  and  $C(4, 7)$ .

$$\text{Slope of line } BC = \frac{7 - 5}{4 - 2} = \frac{2}{2} = 1$$

Let  $m$  be the slope of the required line.

Since the required line is perpendicular to  $BC$ ,

$$\begin{aligned} m \times 1 &= -1 \\ m &= -1 \end{aligned}$$

The required line also pass through the point  $A(1, 4)$ .

The equation of the required straight line is  $y - y_1 = m(x - x_1)$

$$y - 4 = -1(x - 1)$$

$$y - 4 = -x + 1$$

$$\text{we get, } x + y - 5 = 0$$

### 5.5.6 Two Point form

Let  $A(x_1, y_1)$  and  $B(x_2, y_2)$  be two given distinct points. Slope of the straight line passing through these points is given by  $m = \frac{y_2 - y_1}{x_2 - x_1}$ ,  $(x_2 \neq x_1)$ .

From the equation of the straight line in point slope form, we get

$$y - y_1 = \frac{y_2 - y_1}{x_2 - x_1}(x - x_1)$$

Hence,  $\frac{y - y_1}{y_2 - y_1} = \frac{x - x_1}{x_2 - x_1}$  (is the equation of the line in **two-point form**)

**Example 5.23** Find the equation of a straight line passing through  $(5, -3)$  and  $(7, -4)$ .

**Solution** The equation of a straight line passing through the two points  $(x_1, y_1)$  and  $(x_2, y_2)$  is

### Thinking Corner

Is it possible to express, the equation of a straight line in slope-intercept form, when it is parallel to  $Y$  axis?

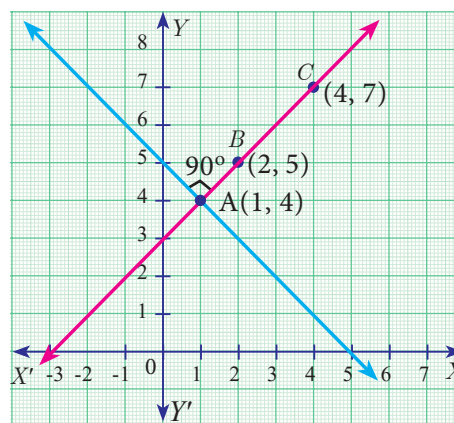

Fig. 5.33



The great mathematical physicists like Galileo and Newton used coordinate geometry to characterize the motions of objects in plane and space.

$$\frac{y - y_1}{y_2 - y_1} = \frac{x - x_1}{x_2 - x_1}$$

Substituting the points we get,

$$\begin{aligned} \frac{y + 3}{-4 + 3} &= \frac{x - 5}{7 - 5} \\ \Rightarrow 2y + 6 &= -x + 5 \end{aligned}$$

Therefore,  $x + 2y + 1 = 0$

**Example 5.24** Two buildings of different heights are located at opposite sides of each other. If a heavy rod is attached joining the terrace of the buildings from (6,10) to (14,12), find the equation of the rod joining the buildings ?

**Solution** Let A(6,10), B(14,12) be the points denoting the terrace of the buildings.

The equation of the rod is the equation of the straight line passing through A(6,10) and B(14,12)

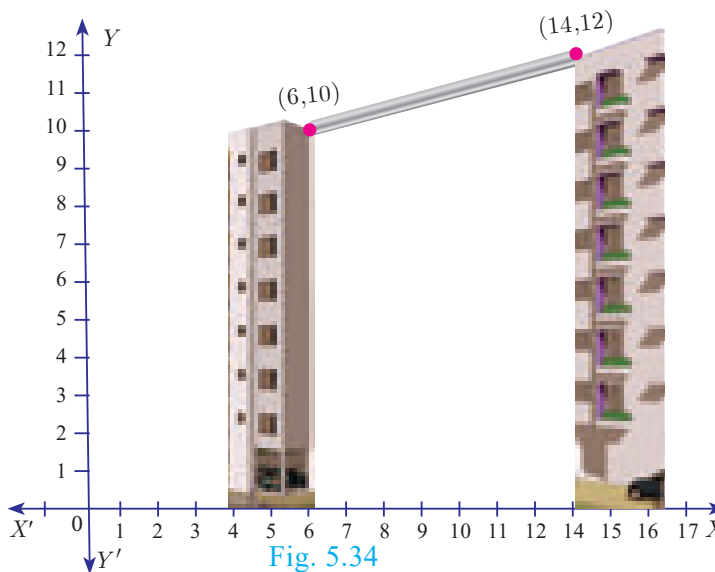

$$\frac{y - y_1}{y_2 - y_1} = \frac{x - x_1}{x_2 - x_1} \text{ gives } \frac{y - 10}{12 - 10} = \frac{x - 6}{14 - 6}$$

$$\frac{y - 10}{2} = \frac{x - 6}{8}$$

Therefore,  $x - 4y + 34 = 0$

Hence, equation of the rod is  $x - 4y + 34 = 0$

### 5.5.7 Intercept Form

We will find the equation of a line whose intercepts are  $a$  and  $b$  on the coordinate axes respectively.

Let PQ be a line meeting X axis at A and Y axis at B. Let OA= $a$ , OB= $b$ . Then the coordinates of A and B are ( $a,0$ ) and ( $0,b$ ) respectively. Therefore, the equation of the line joining A and B is

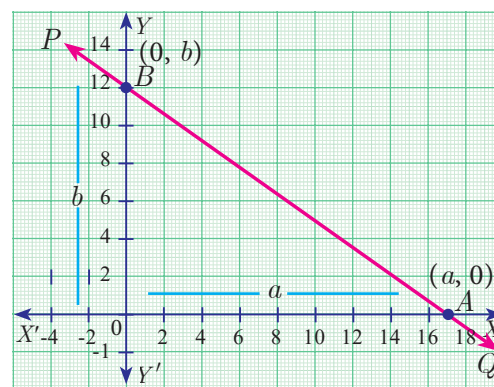

$$\frac{y - 0}{b - 0} = \frac{x - a}{0 - a} \text{ we get, } \frac{y}{b} = \frac{x - a}{-a} \text{ gives } \frac{y}{b} = \frac{-x}{a} + 1$$

Hence,  $\frac{x}{a} + \frac{y}{b} = 1$  (Intercept form of a line)



**Progress Check** Fill the details in respective boxes

Form	When to use?	Name
$y = mx + c$	Slope= $m$ , Intercept= $c$ are given	
$\frac{y - y_1}{y_2 - y_1} = \frac{x - x_1}{x_2 - x_1}$		
	The intercepts are given	Intercept form

**Example 5.25** Find the equation of a line which passes through (5,7) and makes intercepts on the axes equal in magnitude but opposite in sign.

**Solution** Let the  $x$  intercept be ' $a$ ' and  $y$  intercept be ' $-a$ '.

The equation of the line in intercept form is  $\frac{x}{a} + \frac{y}{b} = 1$

$$\Rightarrow \frac{x}{a} + \frac{y}{-a} = 1 \quad (\text{Here } b = -a)$$

$$\therefore x - y = a \quad \dots(1)$$

Since (1) passes through (5,7)

Therefore,  $5 - 7 = a \Rightarrow a = -2$

Thus the required equation of the straight line is  $x - y = -2$ ; or  $x - y + 2 = 0$

**Example 5.26** Find the intercepts made by the line  $4x - 9y + 36 = 0$  on the coordinate axes.

**Solution** Equation of the given line is  $4x - 9y + 36 = 0$

we write it as  $4x - 9y = -36$  (bringing it to the normal form)

Dividing by  $-36$  we get,  $\frac{x}{-9} + \frac{y}{4} = 1 \quad \dots(1)$

Comparing (1) with intercept form, we get  $x$  intercept  $a = -9$ ;  $y$  intercept  $b = 4$

**Example 5.27** A mobile phone is put to use when the battery power is 100%. The percent of battery power ' $y$ ' (in decimal) remaining after using the mobile phone for  $x$  hours is assumed as  $y = -0.25x + 1$

- Find the number of hours elapsed if the battery power is 40%.
- How much time does it take so that the battery has no power?

**Solution**

- To find the time when the battery power is 40%, we have to take  $y = 0.40$

$$0.40 = -0.25x + 1 \Rightarrow 0.25x = 0.60$$

we get,  $x = \frac{0.60}{0.25} = 2.4$  hours.

- If the battery power is 0 then  $y = 0$

Therefore,  $0 = -0.25x + 1$  gives  $0.25x = 1$  hence  $x = 4$  hours.

Thus, after 4 hours, the battery of the mobile phone will have no power.

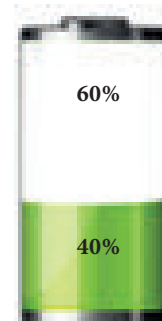

Fig. 5.36



**Example 5.28** A line makes positive intercepts on coordinate axes whose sum is 7 and it passes through  $(-3, 8)$ . Find its equation.

**Solution** If  $a$  and  $b$  are the intercepts then  $a + b = 7$  or  $b = 7 - a$

By intercept form  $\frac{x}{a} + \frac{y}{b} = 1$

We have  $\frac{x}{a} + \frac{y}{7-a} = 1$

As this line pass through the point  $(-3, 8)$ , we have

$$\frac{-3}{a} + \frac{8}{7-a} = 1 \Rightarrow -3(7-a) + 8a = a(7-a)$$

$$-21 + 3a + 8a = 7a - a^2$$

So,  $a^2 + 4a - 21 = 0$

Solving this equation  $(a - 3)(a + 7) = 0$

$$a = 3 \text{ or } a = -7$$

Since  $a$  is positive, we have  $a = 3$  and  $b = 7 - a = 7 - 3 = 4$ .

Hence  $\frac{x}{3} + \frac{y}{4} = 1$

Therefore,  $4x + 3y - 12 = 0$  is the required equation.

**Example 5.29** A circular garden is bounded by East Avenue and Cross Road. Cross Road intersects North Street at  $D$  and East Avenue at  $E$ .  $AD$  is tangential to the circular garden at  $A(3, 10)$ . Using the figure.

- (a) Find the equation of
- East Avenue.
  - North Street
  - Cross Road
- (b) Where does the Cross Road intersect?
- North Street
  - East Avenue

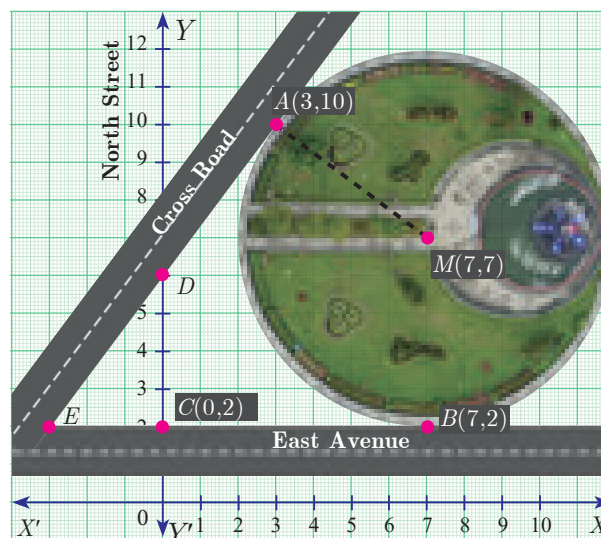

Fig. 5.37

**Solution** (a) (i) East Avenue is the straight line joining  $C(0, 2)$  and  $B(7, 2)$ . Thus the equation of East Avenue is obtained by using two-point form which is

$$\frac{y-2}{2-2} = \frac{x-0}{7-0}$$

$$\frac{y-2}{0} = \frac{x}{7} \Rightarrow y = 2$$

(ii) Since the point  $D$  lie vertically above  $C(0,2)$ . The  $x$  coordinate of  $D$  is 0.

Since any point on North Street has  $x$  coordinate value 0.

The equation of North Street is  $x = 0$

(iii) To find equation of Cross Road.

Center of circular garden  $M$  is at  $(7, 7)$ ,  $A$  is  $(3, 10)$

We first find slope of  $MA$ , which we call  $m_1$

$$\text{Thus } m_1 = \frac{10 - 7}{3 - 7} = \frac{-3}{4}.$$

Since the Cross Road is perpendicular to  $MA$ , if  $m_2$  is the slope of the

Cross Road then,  $m_1 m_2 = -1$  gives  $\frac{-3}{4} m_2 = -1$  so  $m_2 = \frac{4}{3}$ .

Now, the cross road has slope  $\frac{4}{3}$  and it passes through the point  $A(3,10)$ .

The equation of the Cross Road is  $y - 10 = \frac{4}{3}(x - 3)$

$$3y - 30 = 4x - 12$$

$$\text{Hence, } 4x - 3y + 18 = 0$$

(b) (i) If  $D$  is  $(0, k)$  then  $D$  is a point on the Cross Road.

Therefore, substituting  $x = 0$ ,  $y = k$  in the equation of Cross Road,

we get,  $0 - 3k + 18 = 0$

Value of  $k = 6$

Therefore,  $D$  is  $(0, 6)$

(ii) To find  $E$ , let  $E$  be  $(q, 2)$

Put  $y = 2$  in the equation of the Cross Road,

we get,  $4q - 6 + 18 = 0$

$$4q = -12 \text{ gives } q = -3$$

Therefore, The point  $E$  is  $(-3, 2)$

Thus the Cross Road meets the North Street at  $D(0, 6)$  and

East Avenue at  $E(-3, 2)$ .



### Progress Check

Fill the details in respective boxes

S.No.	Equation	Slope	$x$ intercept	$y$ intercept
1	$3x - 4y + 2 = 0$			
2	$y = 14x$			0
3			2	-3



### Activity 4

If line  $l_1$  is perpendicular to line  $l_2$  and line  $l_3$  has slope 3 then

- (i) find the equation of line  $l_1$
- (ii) find the equation of line  $l_2$
- (iii) find the equation of line  $l_3$

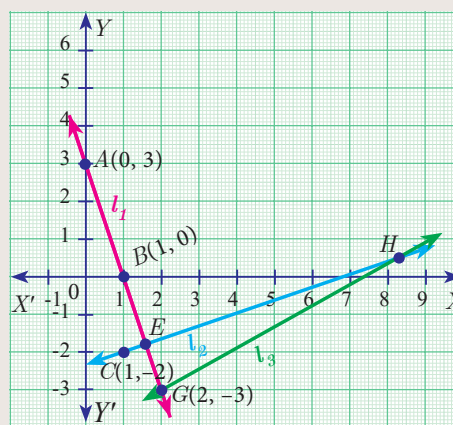

Fig. 5.38



### Activity 5

A ladder is placed against a vertical wall with its foot touching the horizontal floor. Find the equation of the ladder under the following conditions.

No.	Condition	Picture	Equation of the ladder
(i)	The ladder is inclined at $60^\circ$ to the floor and it touches the wall at $(0, 8)$	<p style="text-align: center;">Fig. 5.39</p>	_____
(ii)	The foot and top of the ladder are at the points $(2, 4)$ and $(5, 1)$	_____	_____



### Exercise 5.3

- Find the equation of a straight line passing through the mid-point of a line segment joining the points  $(1, -5)$ ,  $(4, 2)$  and parallel to (i)  $X$  axis (ii)  $Y$  axis
- The equation of a straight line is  $2(x - y) + 5 = 0$ . Find its slope, inclination and intercept on the  $Y$  axis.
- Find the equation of a line whose inclination is  $30^\circ$  and making an intercept  $-3$  on the  $Y$  axis.
- Find the slope and  $y$  intercept of  $\sqrt{3}x + (1 - \sqrt{3})y = 3$ .
- Find the value of ' $a$ ', if the line through  $(-2, 3)$  and  $(8, 5)$  is perpendicular to  $y = ax + 2$

6. The hill in the form of a right triangle has its foot at  $(19, 3)$ . The inclination of the hill to the ground is  $45^\circ$ . Find the equation of the hill joining the foot and top.
7. Find the equation of a line through the given pair of points
  - (i)  $\left(2, \frac{2}{3}\right)$  and  $\left(\frac{-1}{2}, -2\right)$
  - (ii)  $(2, 3)$  and  $(-7, -1)$
8. A cat is located at the point  $(-6, -4)$  in  $xy$  plane. A bottle of milk is kept at  $(5, 11)$ . The cat wish to consume the milk travelling through shortest possible distance. Find the equation of the path it needs to take its milk.
9. Find the equation of the median and altitude of  $\triangle ABC$  through  $A$  where the vertices are  $A(6, 2)$ ,  $B(-5, -1)$  and  $C(1, 9)$
10. Find the equation of a straight line which has slope  $\frac{-5}{4}$  and passing through the point  $(-1, 2)$ .
11. You are downloading a song. The percent  $y$  (in decimal form) of mega bytes remaining to get downloaded in  $x$  seconds is given by  $y = -0.1x + 1$ .
  - (i) find the total MB of the song.
  - (ii) after how many seconds will 75% of the song gets downloaded?
  - (iii) after how many seconds the song will be downloaded completely?
12. Find the equation of a line whose intercepts on the  $x$  and  $y$  axes are given below.
  - (i) 4, -6
  - (ii)  $-5, \frac{3}{4}$
13. Find the intercepts made by the following lines on the coordinate axes.
  - (i)  $3x - 2y - 6 = 0$
  - (ii)  $4x + 3y + 12 = 0$
14. Find the equation of a straight line
  - (i) passing through  $(1, -4)$  and has intercepts which are in the ratio 2:5
  - (ii) passing through  $(-8, 4)$  and making equal intercepts on the coordinate axes

## 5.6 General Form of a Straight Line

The linear equation (first degree polynomial in two variables  $x$  and  $y$ )  $ax + by + c = 0$  (where  $a$ ,  $b$  and  $c$  are real numbers such that at least one of  $a$ ,  $b$  is non-zero) always represents a straight line. This is the general form of a straight line.

Now, let us find out the equations of a straight line in the following cases

- (i) parallel to  $ax + by + c = 0$
- (ii) perpendicular to  $ax + by + c = 0$

### 5.6.1 Equation of a line parallel to the line $ax + by + c = 0$

The equation of all lines **parallel to the line**  $ax + by + c = 0$  can be put in the form  $ax + by + k = 0$  for different values of  $k$ .

### 5.6.2 Equation of a line perpendicular to the line $ax + by + c = 0$

The equation of all lines **perpendicular to the line**  $ax + by + c = 0$  can be written as  $bx - ay + k = 0$  for different values of  $k$ .



Two straight lines  $a_1x + b_1y + c_1 = 0$  and  $a_2x + b_2y + c_2 = 0$  where the coefficients are non-zero, are

(i) parallel if and only if  $\frac{a_1}{a_2} = \frac{b_1}{b_2}$ ; That is,  $a_1b_2 - a_2b_1 = 0$

(ii) perpendicular if and only if  $a_1a_2 + b_1b_2 = 0$



**Progress Check** Fill the details in respective boxes

No.	Equations	Parallel or perpendicular	S.No.	Equations	Parallel or perpendicular
1	$5x + 2y + 5 = 0$ $5x + 2y - 3 = 0$		3	$8x - 10y + 11 = 0$ $4x - 5y + 16 = 0$	
2	$3x - 7y - 6 = 0$ $7x + 3y + 8 = 0$		4	$2y - 9x - 7 = 0$ $27y + 6x - 21 = 0$	

### 5.6.3 Slope of a straight line

The general form of the equation of a straight line is  $ax + by + c = 0$ . (at least one of  $a, b$  is non-zero)

coefficient of  $x = a$ , coefficient of  $y = b$ , constant term  $= c$ .

The above equation can be rewritten as  $by = -ax - c$

gives  $y = -\frac{a}{b}x - \frac{c}{b}$ , if  $b \neq 0$  ... (1)

comparing (1) with the form  $y = mx + l$

We get, slope  $m = -\frac{a}{b}$

$$m = \frac{-\text{coefficient of } x}{\text{coefficient of } y}$$

$$y \text{ intercept } l = -\frac{c}{b}$$

$$y \text{ intercept} = \frac{-\text{constant term}}{\text{coefficient of } y}$$

#### Thinking Corner

How many straight lines do you have with slope 1?

**Example 5.30** Find the slope of the straight line  $6x + 8y + 7 = 0$ .

**Solution** Given  $6x + 8y + 7 = 0$

$$\text{slope } m = \frac{-\text{coefficient of } x}{\text{coefficient of } y} = -\frac{6}{8} = -\frac{3}{4}$$

Therefore, the slope of the straight line is  $-\frac{3}{4}$ .

**Example 5.31** Find the slope of the line which is

(i) parallel to  $3x - 7y = 11$

(ii) perpendicular to  $2x - 3y + 8 = 0$

**Solution** (i) Given straight line is  $3x - 7y = 11$

$$\Rightarrow 3x - 7y - 11 = 0$$

$$\text{Slope } m = \frac{-3}{-7} = \frac{3}{7}$$

Since parallel lines have same slopes, slope of any line parallel to

$$3x - 7y = 11 \text{ is } \frac{3}{7}.$$

(ii) Given straight line is  $2x - 3y + 8 = 0$

$$\text{Slope } m = \frac{-2}{-3} = \frac{2}{3}$$

Since product of slopes is  $-1$  for perpendicular lines, slope of any line

$$\text{perpendicular to } 2x - 3y + 8 = 0 \text{ is } \frac{-1}{\frac{2}{3}} = \frac{-3}{2}$$

**Example 5.32** Show that the straight lines  $2x + 3y - 8 = 0$  and  $4x + 6y + 18 = 0$  are parallel.

**Solution** Slope of the straight line  $2x + 3y - 8 = 0$  is

$$m_1 = \frac{-\text{coefficient of } x}{\text{coefficient of } y}$$

$$m_1 = \frac{-2}{3}$$

Slope of the straight line  $4x + 6y + 18 = 0$  is

$$m_2 = \frac{-4}{6} = \frac{-2}{3}$$

$$\text{Here, } m_1 = m_2$$

That is, slopes are equal. Hence, the two straight lines are parallel.

**Example 5.33** Show that the straight lines  $x - 2y + 3 = 0$  and  $6x + 3y + 8 = 0$  are perpendicular.

**Solution** Slope of the straight line  $x - 2y + 3 = 0$  is

$$m_1 = \frac{-1}{-2} = \frac{1}{2}$$

Slope of the straight line  $6x + 3y + 8 = 0$  is

$$m_2 = \frac{-6}{3} = -2$$

$$\text{Now, } m_1 \times m_2 = \frac{1}{2} \times (-2) = -1$$

Hence, the two straight lines are perpendicular.

**Example 5.34** Find the equation of a straight line which is parallel to the line  $3x - 7y = 12$  and passing through the point  $(6, 4)$ .

#### Aliter

$$a_1 = 2, b_1 = 3$$

$$a_2 = 4, b_2 = 6$$

$$\frac{a_1}{a_2} = \frac{2}{4} = \frac{1}{2}$$

$$\frac{b_1}{b_2} = \frac{3}{6} = \frac{1}{2}$$

$$\text{Therefore, } \frac{a_1}{a_2} = \frac{b_1}{b_2}$$

Hence the lines are parallel.

#### Aliter

$$a_1 = 1, b_1 = -2;$$

$$a_2 = 6, b_2 = 3$$

$$a_1 a_2 + b_1 b_2 = 6 - 6 = 0$$

The lines are perpendicular.

**Solution** Equation of the straight line, parallel to  $3x - 7y - 12 = 0$  is  $3x - 7y + k = 0$

Since it passes through the point  $(6, 4)$

$$3(6) - 7(4) + k = 0$$

$$k = 28 - 18 = 10$$

Therefore, equation of the required straight line is  $3x - 7y + 10 = 0$ .

**Example 5.35** Find the equation of a straight line perpendicular to the line  $y = \frac{4}{3}x - 7$  and passing through the point  $(7, -1)$ .

**Solution** The equation  $y = \frac{4}{3}x - 7$  can be written as  $4x - 3y - 21 = 0$ .

Equation of a straight line perpendicular to  $4x - 3y - 21 = 0$  is  $3x + 4y + k = 0$

Since it passes through the point  $(7, -1)$ ,

$$21 - 4 + k = 0 \quad \text{we get, } k = -17$$

Therefore, equation of the required straight line is  $3x + 4y - 17 = 0$ .

**Example 5.36** Find the equation of a straight line parallel to  $Y$  axis and passing through the point of intersection of the lines  $4x + 5y = 13$  and  $x - 8y + 9 = 0$ .

**Solution** Given lines  $4x + 5y - 13 = 0$  ... (1)

$$x - 8y + 9 = 0 \quad \dots (2)$$

To find the point of intersection, solve equation (1) and (2)

$$\begin{array}{r} \begin{array}{ccc} x & y & 1 \\ 5 & -13 & 4 \\ -8 & 9 & 1 \end{array} \\ \hline \frac{x}{45 - 104} = \frac{y}{-13 - 36} = \frac{1}{-32 - 5} \\ \frac{x}{-59} = \frac{y}{-49} = \frac{1}{-37} \end{array}$$

$$x = \frac{59}{37}, \quad y = \frac{49}{37}$$

Therefore, the point of intersection  $(x, y) = \left(\frac{59}{37}, \frac{49}{37}\right)$

The equation of line parallel to  $Y$  axis is  $x = c$ .

It passes through  $(x, y) = \left(\frac{59}{37}, \frac{49}{37}\right)$ . Therefore,  $c = \frac{59}{37}$ .

The equation of the line is  $x = \frac{59}{37} \Rightarrow 37x - 59 = 0$

**Example 5.37** The line joining the points  $A(0, 5)$  and  $B(4, 1)$  is a tangent to a circle whose centre  $C$  is at the point  $(4, 4)$  find

- (i) the equation of the line  $AB$ .
- (ii) the equation of the line through  $C$  which is perpendicular to the line  $AB$ .
- (iii) the coordinates of the point of contact of tangent line  $AB$  with the circle.

**Solution** (i) Equation of line AB,  $A(0,5)$  and  $B(4,1)$

$$\frac{y - y_1}{y_2 - y_1} = \frac{x - x_1}{x_2 - x_1}$$

$$\frac{y - 5}{1 - 5} = \frac{x - 0}{4 - 0}$$

$$4(y - 5) = -4x \Rightarrow y - 5 = -x$$

$$x + y - 5 = 0$$

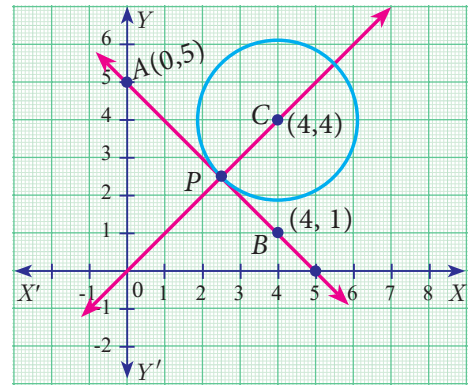

Fig. 5.40

(ii) The equation of a line which is perpendicular to the line  $AB: x + y - 5 = 0$  is  $x - y + k = 0$

Since it is passing through the point  $(4,4)$ , we have

$$4 - 4 + k = 0 \Rightarrow k = 0$$

The equation of a line which is perpendicular to  $AB$  and through  $C$  is  $x - y = 0$

(iii) The coordinate of the point of contact  $P$  of the tangent line  $AB$  with the circle is point of intersection of lines.

$$x + y - 5 = 0 \quad \text{and} \quad x - y = 0$$

solving, we get  $x = \frac{5}{2}$  and  $y = \frac{5}{2}$

Therefore, the coordinate of the point of contact is  $P\left(\frac{5}{2}, \frac{5}{2}\right)$ .

**Thinking Corner**



1. Find the number of point of intersection of two straight lines.
2. Find the number of straight lines perpendicular to the line  $2x - 3y + 6 = 0$ .



**Activity 6**

Find the equation of a straight line for the given diagrams

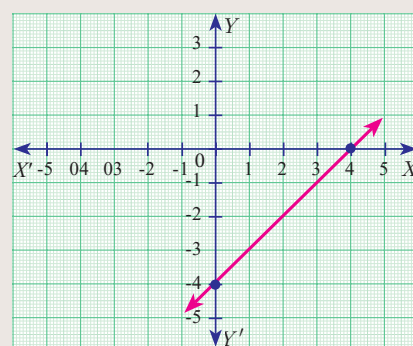
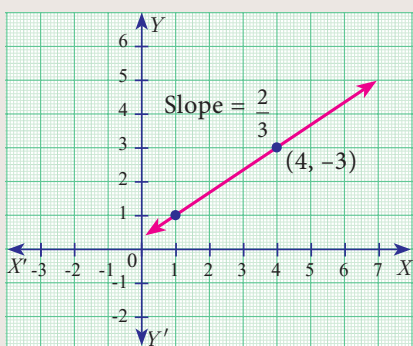
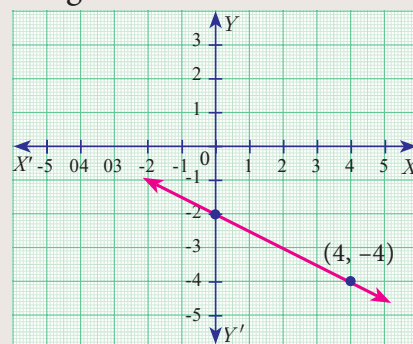
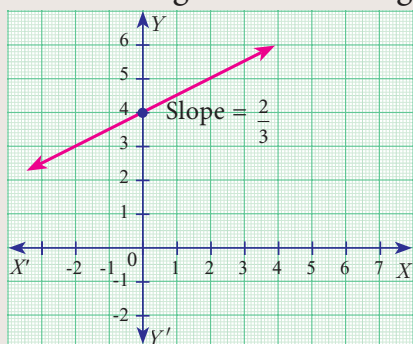

Fig. 5.41





### Exercise 5.4

- Find the slope of the following straight lines (i)  $5y - 3 = 0$  (ii)  $7x - \frac{3}{17} = 0$
- Find the slope of the line which is
  - parallel to  $y = 0.7x - 11$
  - perpendicular to the line  $x = -11$
- Check whether the given lines are parallel or perpendicular
  - $\frac{x}{3} + \frac{y}{4} + \frac{1}{7} = 0$  and  $\frac{2x}{3} + \frac{y}{2} + \frac{1}{10} = 0$
  - $5x + 23y + 14 = 0$  and  $23x - 5y + 9 = 0$
- If the straight lines  $12y = -(p + 3)x + 12$ ,  $12x - 7y = 16$  are perpendicular then find 'p'.
- Find the equation of a straight line passing through the point  $P(-5, 2)$  and parallel to the line joining the points  $Q(3, -2)$  and  $R(-5, 4)$ .
- Find the equation of a line passing through  $(6, -2)$  and perpendicular to the line joining the points  $(6, 7)$  and  $(2, -3)$ .
- $A(-3, 0)$ ,  $B(10, -2)$  and  $C(12, 3)$  are the vertices of  $\triangle ABC$ . Find the equation of the altitude through  $A$  and  $B$ .
- Find the equation of the perpendicular bisector of the line joining the points  $A(-4, 2)$  and  $B(6, -4)$ .
- Find the equation of a straight line through the intersection of lines  $7x + 3y = 10$ ,  $5x - 4y = 1$  and parallel to the line  $13x + 5y + 12 = 0$
- Find the equation of a straight line through the intersection of lines  $5x - 6y = 2$ ,  $3x + 2y = 10$  and perpendicular to the line  $4x - 7y + 13 = 0$
- Find the equation of a straight line joining the point of intersection of  $3x + y + 2 = 0$  and  $x - 2y - 4 = 0$  to the point of intersection of  $7x - 3y = -12$  and  $2y = x + 3$
- Find the equation of a straight line through the point of intersection of the lines  $8x + 3y = 18$ ,  $4x + 5y = 9$  and bisecting the line segment joining the points  $(5, -4)$  and  $(-7, 6)$ .



### Exercise 5.5



#### Multiple choice questions

- The area of triangle formed by the points  $(-5, 0)$ ,  $(0, -5)$  and  $(5, 0)$  is  
 (A) 0 sq.units (B) 25 sq.units (C) 5 sq.units (D) none of these
- A man walks near a wall, such that the distance between him and the wall is 10 units. Consider the wall to be the  $Y$  axis. The path travelled by the man is  
 (A)  $x = 10$  (B)  $y = 10$  (C)  $x = 0$  (D)  $y = 0$
- The straight line given by the equation  $x = 11$  is  
 (A) parallel to  $X$  axis (B) parallel to  $Y$  axis  
 (C) passing through the origin (D) passing through the point  $(0, 11)$



4. If  $(5,7)$ ,  $(3,p)$  and  $(6,6)$  are collinear, then the value of  $p$  is  
 (A) 3 (B) 6 (C) 9 (D) 12
5. The point of intersection of  $3x - y = 4$  and  $x + y = 8$  is  
 (A)  $(5,3)$  (B)  $(2,4)$  (C)  $(3,5)$  (D)  $(4,4)$
6. The slope of the line joining  $(12,3)$ ,  $(4,a)$  is  $\frac{1}{8}$ . The value of 'a' is  
 (A) 1 (B) 4 (C)  $-5$  (D) 2
7. The slope of the line which is perpendicular to a line joining the points  $(0,0)$  and  $(-8,8)$  is  
 (A)  $-1$  (B) 1 (C)  $\frac{1}{3}$  (D)  $-8$
8. If slope of the line  $PQ$  is  $\frac{1}{\sqrt{3}}$  then slope of the perpendicular bisector of  $PQ$  is  
 (A)  $\sqrt{3}$  (B)  $-\sqrt{3}$  (C)  $\frac{1}{\sqrt{3}}$  (D) 0
9. If  $A$  is a point on the  $Y$  axis whose ordinate is 8 and  $B$  is a point on the  $X$  axis whose abscissae is 5 then the equation of the line  $AB$  is  
 (A)  $8x + 5y = 40$  (B)  $8x - 5y = 40$  (C)  $x = 8$  (D)  $y = 5$
10. The equation of a line passing through the origin and perpendicular to the line  $7x - 3y + 4 = 0$  is  
 (A)  $7x - 3y + 4 = 0$  (B)  $3x - 7y + 4 = 0$  (C)  $3x + 7y = 0$  (D)  $7x - 3y = 0$
11. Consider four straight lines  
 (i)  $l_1$ ;  $3y = 4x + 5$  (ii)  $l_2$ ;  $4y = 3x - 1$  (iii)  $l_3$ ;  $4y + 3x = 7$  (iv)  $l_4$ ;  $4x + 3y = 2$   
 Which of the following statement is true ?  
 (A)  $l_1$  and  $l_2$  are perpendicular (B)  $l_1$  and  $l_4$  are parallel  
 (C)  $l_2$  and  $l_4$  are perpendicular (D)  $l_2$  and  $l_3$  are parallel
12. A straight line has equation  $8y = 4x + 21$ . Which of the following is true  
 (A) The slope is 0.5 and the  $y$  intercept is 2.6  
 (B) The slope is 5 and the  $y$  intercept is 1.6  
 (C) The slope is 0.5 and the  $y$  intercept is 1.6  
 (D) The slope is 5 and the  $y$  intercept is 2.6
13. When proving that a quadrilateral is a trapezium, it is necessary to show  
 (A) Two sides are parallel. (B) Two parallel and two non-parallel sides.  
 (C) Opposite sides are parallel. (D) All sides are of equal length.
14. When proving that a quadrilateral is a parallelogram by using slopes you must find  
 (A) The slopes of two sides (B) The slopes of two pair of opposite sides  
 (C) The lengths of all sides (D) Both the lengths and slopes of two sides
15.  $(2, 1)$  is the point of intersection of two lines.  
 (A)  $x - y - 3 = 0$ ;  $3x - y - 7 = 0$  (B)  $x + y = 3$ ;  $3x + y = 7$   
 (C)  $3x + y = 3$ ;  $x + y = 7$  (D)  $x + 3y - 3 = 0$ ;  $x - y - 7 = 0$

## Unit Exercise - 5



1. PQRS is a rectangle formed by joining the points  $P(-1, -1)$ ,  $Q(-1, 4)$ ,  $R(5, 4)$  and  $S(5, -1)$ .  $A$ ,  $B$ ,  $C$  and  $D$  are the mid-points of  $PQ$ ,  $QR$ ,  $RS$  and  $SP$  respectively. Is the quadrilateral  $ABCD$  a square, a rectangle or a rhombus? Justify your answer.
2. The area of a triangle is 5 sq.units. Two of its vertices are  $(2, 1)$  and  $(3, -2)$ . The third vertex is  $(x, y)$  where  $y = x + 3$ . Find the coordinates of the third vertex.
3. Find the area of a triangle formed by the lines  $3x + y - 2 = 0$ ,  $5x + 2y - 3 = 0$  and  $2x - y - 3 = 0$
4. If vertices of a quadrilateral are at  $A(-5, 7)$ ,  $B(-4, k)$ ,  $C(-1, -6)$  and  $D(4, 5)$  and its area is 72 sq.units. Find the value of  $k$ .
5. Without using distance formula, show that the points  $(-2, -1)$ ,  $(4, 0)$ ,  $(3, 3)$  and  $(-3, 2)$  are vertices of a parallelogram.
6. Find the equations of the lines, whose sum and product of intercepts are 1 and  $-6$  respectively.
7. The owner of a milk store finds that, he can sell 980 litres of milk each week at ₹14/litre and 1220 litres of milk each week at ₹16/litre. Assuming a linear relationship between selling price and demand, how many litres could he sell weekly at ₹17/litre?
8. Find the image of the point  $(3, 8)$  with respect to the line  $x + 3y = 7$  assuming the line to be a plane mirror.
9. Find the equation of a line passing through the point of intersection of the lines  $4x + 7y - 3 = 0$  and  $2x - 3y + 1 = 0$  that has equal intercepts on the axes.
10. A person standing at a junction (crossing) of two straight paths represented by the equations  $2x - 3y + 4 = 0$  and  $3x + 4y - 5 = 0$  seek to reach the path whose equation is  $6x - 7y + 8 = 0$  in the least time. Find the equation of the path that he should follow.

## Points to Remember



- The area of a triangle formed by the points  $(x_1, y_1)$ ,  $(x_2, y_2)$  and  $(x_3, y_3)$  is  $\frac{1}{2} \{ (x_1 y_2 + x_2 y_3 + x_3 y_1) - (x_2 y_1 + x_3 y_2 + x_1 y_3) \}$  sq.units
- Three points  $A(x_1, y_1)$ ,  $B(x_2, y_2)$  and  $C(x_3, y_3)$  are collinear if and only if
  - (i) area of  $\triangle ABC = 0$  or  $x_1 y_2 + x_2 y_3 + x_3 y_1 = x_2 y_1 + x_3 y_2 + x_1 y_3$
  - (ii) slope of  $AB =$  slope of  $BC$  or slope of  $AC$
- The area of a quadrilateral formed by the four points  $(x_1, y_1)$ ,  $(x_2, y_2)$ ,  $(x_3, y_3)$  and  $(x_4, y_4)$  is  $\frac{1}{2} \{ (x_1 y_2 + x_2 y_3 + x_3 y_4 + x_4 y_1) - (x_2 y_1 + x_3 y_2 + x_4 y_3 + x_1 y_4) \}$  sq.units.
- If a line makes an angle  $\theta$  with the positive direction of  $X$  axis, then its slope  $m = \tan \theta$ .
- If  $A(x_1, y_1)$ ,  $B(x_2, y_2)$  are two distinct points then the slope of  $AB$  is  $\frac{y_2 - y_1}{x_2 - x_1}$ .
- Slope of line  $ax + by + c = 0$  is  $m = \frac{-a}{b}$ .

### Equation of straight line in various forms

Form	Name	Form	Name
$ax + by + c = 0$	General form	$\frac{x}{a} + \frac{y}{b} = 1$	Intercept form
$y - y_1 = m(x - x_1)$	Point-slope form	$x = c$	Parallel to Y axis
$y = mx + c$	Slope-intercept	$y = b$	Parallel to X axis
$\frac{y - y_1}{y_2 - y_1} = \frac{x - x_1}{x_2 - x_1}$	Two point form		

- Two straight lines are parallel if and only if their slopes are equal.
- Two straight lines with well defined slopes  $m_1, m_2$  are perpendicular if and only if  $m_1 \times m_2 = -1$ .

### ICT CORNER



#### ICT 5.1

**Step 1:** Open the Browser type the URL Link given below (or) Scan the QR Code. GeoGebra work book named “Co-Ordinate Geometry” will open. In the left side of the work book there are many activity related to mensuration chapter. Select the work sheet “Area of a Quadrilateral”

**Step 2:** In the given worksheet you can change the Question by clicking on “New Problem”. Move the slider to see the steps. Work out each problem and verify your answer.

#### Step 1

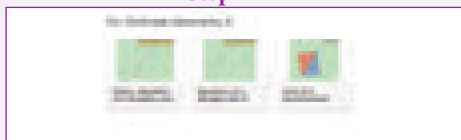

#### Step 2

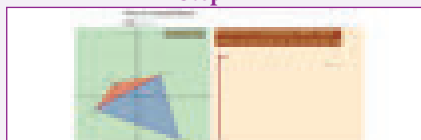

#### Expected results



#### ICT 5.2

**Step 1:** Open the Browser type the URL Link given below (or) Scan the QR Code. GeoGebra work book named “Co-Ordinate Geometry” will open. In the left side of the work book there are many activity related to mensuration chapter. Select the work sheet “Slope\_Equation of a Straight Line”

**Step 2:** In the given worksheet you can change the Line by Dragging the points A and B on graph. Click on the Check boxes on Left Hand Side to see various forms of same straight line.

#### Step 1

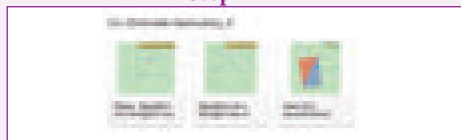

#### Step 2

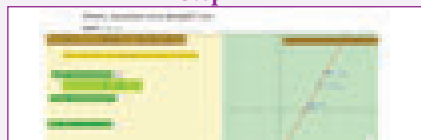

#### Expected results

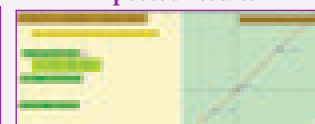

You can repeat the same steps for other activities

<https://www.geogebra.org/m/jfr2zzgy#chapter/356195>

or Scan the QR Code.



# TRIGONOMETRY

*“The deep study of nature is the most fruitful source of mathematical discoveries”*  
- Joseph Fourier.

## 6

French mathematician **Francois Viète** used trigonometry in the study of Algebra for solving certain equations by making suitable trigonometric substitutions. His famous formula for  $\pi$  can be derived with repeated use of trigonometric ratios. One of his famous works titled Canon Mathematics covers trigonometry; it contains trigonometric tables, it also gives the mathematics behind the construction of the tables, and it details how to solve both plane and spherical triangles. He also provided the means for extracting roots and solutions of equations of degree at most six. Viète introduced the term “coefficient” in mathematics. He provided a simple formula relating the roots of a equation with its coefficients. He also provided geometric methods to solve doubling the cube and trisecting the angle problems. He was also involved in deciphering codes.

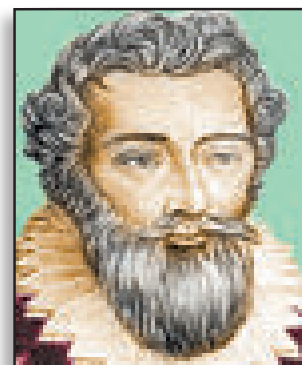

**Francois Viète**  
(1540–1603 AD(CE))



## Learning Outcomes

- To recall trigonometric ratios.
- To recall fundamental relations between the trigonometric ratios of an angle.
- To recall trigonometric ratios of complementary angles.
- To understand trigonometric identities.
- To know methods of solving problems concerning heights and distances of various objects.



## 6.1 Introduction

From very ancient times surveyors, navigators and astronomers have made use of triangles to determine distances that could not be measured directly. This gave birth to the branch of mathematics what we call today as “**Trigonometry**”.

**Hipparchus of Rhodes** around 200 BC(BCE), constructed a table of chord lengths for a circle of circumference  $360 \times 60 = 21600$  units which corresponds to one unit of circumference for each minute of arc. For this achievement, Hipparchus is considered as “**The Father of Trigonometry**” since it became the basis for further development.

Indian scholars of the 5th century AD(CE), realized that working with half-chords for half-angles greatly simplified the theory of chords and its application to astronomy. Mathematicians like Aryabhata, the two Bhaskaras and several others developed astonishingly sophisticated techniques for calculating half-chord (Jya) values.

Mathematician Abu Al-Wafa of Baghdad believed to have invented the tangent function, which he called the “Shadow”. Arabic scholars did not know how to translate the word Jya, into their texts and simply wrote jiba as a close approximate word.

Misinterpreting the Arabic word ‘jiba’ for ‘cove’ or ‘bay’, translators wrote the Arabic word ‘jiba’ as ‘sinus’ in Latin to represent the half-chord. From this, we have the name ‘sine’ used to this day. The word “Trigonometry” itself was invented by German mathematician **Bartholomaeus Pitiscus** in the beginning of 17th century AD(CE).

## Recall

### Trigonometric Ratios

Let  $0^\circ < \theta < 90^\circ$

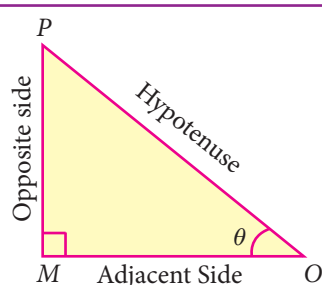

Fig. 6.1

Let us take right triangle  $OMP$

$$\sin \theta = \frac{\text{Opposite side}}{\text{Hypotenuse}} = \frac{MP}{OP}$$

$$\cos \theta = \frac{\text{Adjacent side}}{\text{Hypotenuse}} = \frac{OM}{OP}$$

From the above two ratios we can obtain other four trigonometric ratios as follows.

$$\tan \theta = \frac{\sin \theta}{\cos \theta}; \cot \theta = \frac{\cos \theta}{\sin \theta};$$

$$\operatorname{cosec} \theta = \frac{1}{\sin \theta}; \sec \theta = \frac{1}{\cos \theta}$$

### Note

All right triangles with  $\theta$  as one of the angle are similar. Hence the trigonometric ratios defined through such right angle triangles do not depend on the triangle chosen.

### Trigonometric ratios of complementary angle

$\sin(90^\circ - \theta) = \cos \theta$	$\cos(90^\circ - \theta) = \sin \theta$	$\tan(90^\circ - \theta) = \cot \theta$
$\operatorname{cosec}(90^\circ - \theta) = \sec \theta$	$\sec(90^\circ - \theta) = \operatorname{cosec} \theta$	$\cot(90^\circ - \theta) = \tan \theta$

### Visual proof of trigonometric complementary angle

Consider a semicircle of radius 1 as shown in the figure.

Let  $\angle QOP = \theta$ .

Then  $\angle QOR = 90^\circ - \theta$ , so that  $OPQR$  forms a rectangle.

From triangle  $OPQ$ ,  $\frac{OP}{OQ} = \cos \theta$



But  $OQ = \text{radius} = 1$   
 $\therefore OP = OQ \cos \theta = \cos \theta$

Similarly,  $\frac{PQ}{OQ} = \sin \theta$   
 $\Rightarrow PQ = OQ \sin \theta = \sin \theta$  ( $\because OQ = 1$ )  
 $OP = \cos \theta, PQ = \sin \theta \dots (1)$

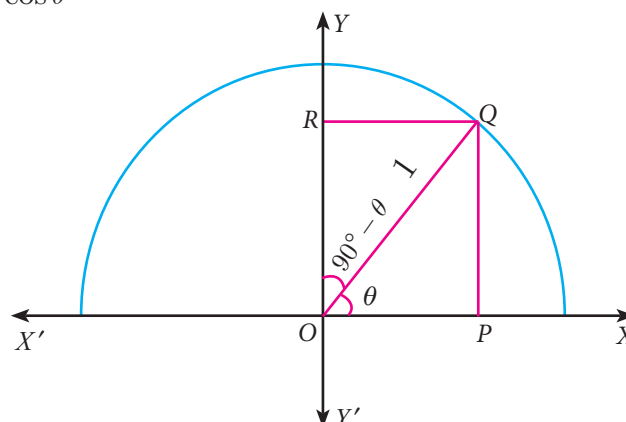

Fig. 6.2

Now, from triangle  $QOR$ ,  
 we have  $\frac{OR}{OQ} = \cos(90^\circ - \theta)$

$\therefore OR = OQ \cos(90^\circ - \theta)$   
 $OR = \cos(90^\circ - \theta)$

Similarly,  $\frac{RQ}{OQ} = \sin(90^\circ - \theta)$

Then,  $RQ = \sin(90^\circ - \theta)$   
 $OR = \cos(90^\circ - \theta), RQ = \sin(90^\circ - \theta) \dots (2)$

$\therefore OPQR$  is a rectangle,

$OP = RQ$  and  $OR = PQ$

Therefore, from (1) and (2) we get,

$\sin(90^\circ - \theta) = \cos \theta$  and  $\cos(90^\circ - \theta) = \sin \theta$

**Note**

$(\sin \theta)^2 = \sin^2 \theta$	$(\operatorname{cosec} \theta)^2 = \operatorname{cosec}^2 \theta$
$(\cos \theta)^2 = \cos^2 \theta$	$(\sec \theta)^2 = \sec^2 \theta$
$(\tan \theta)^2 = \tan^2 \theta$	$(\cot \theta)^2 = \cot^2 \theta$

**Table of Trigonometric Ratios for  $0^\circ, 30^\circ, 45^\circ, 60^\circ, 90^\circ$**

$\theta$	$0^\circ$	$30^\circ$	$45^\circ$	$60^\circ$	$90^\circ$
$\sin \theta$	0	$\frac{1}{2}$	$\frac{1}{\sqrt{2}}$	$\frac{\sqrt{3}}{2}$	1
$\cos \theta$	1	$\frac{\sqrt{3}}{2}$	$\frac{1}{\sqrt{2}}$	$\frac{1}{2}$	0
$\tan \theta$	0	$\frac{1}{\sqrt{3}}$	1	$\sqrt{3}$	undefined
$\operatorname{cosec} \theta$	undefined	2	$\sqrt{2}$	$\frac{2}{\sqrt{3}}$	1
$\sec \theta$	1	$\frac{2}{\sqrt{3}}$	$\sqrt{2}$	2	undefined
$\cot \theta$	undefined	$\sqrt{3}$	1	$\frac{1}{\sqrt{3}}$	0



### Thinking Corner



1. When will the values of  $\sin \theta$  and  $\cos \theta$  be equal?
2. For what values of  $\theta$ ,  $\sin \theta = 2$ ?
3. Among the six trigonometric quantities, as the value of angle  $\theta$  increase from  $0^\circ$  to  $90^\circ$ , which of the six trigonometric quantities has undefined values?
4. Is it possible to have eight trigonometric ratios?
5. Let  $0^\circ \leq \theta \leq 90^\circ$ . For what values of  $\theta$  does
  - (i)  $\sin \theta > \cos \theta$     (ii)  $\cos \theta > \sin \theta$     (iii)  $\sec \theta = 2 \tan \theta$     (iv)  $\operatorname{cosec} \theta = 2 \cot \theta$

## 6.2 Trigonometric Identities

For all real values of  $\theta$ , we have the following three identities.

(i)  $\sin^2 \theta + \cos^2 \theta = 1$       (ii)  $1 + \tan^2 \theta = \sec^2 \theta$       (iii)  $1 + \cot^2 \theta = \operatorname{cosec}^2 \theta$

These identities are termed as three fundamental identities of trigonometry.

We will now prove them as follows.

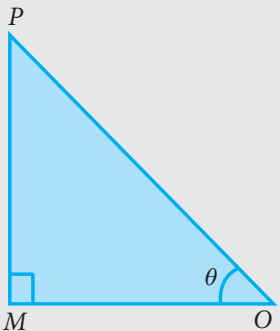
Picture	Identity	Proof
 <p>Fig. 6.3</p>	$\sin^2 \theta + \cos^2 \theta = 1$	<p>In the right angled <math>\Delta OMP</math>, we have</p> $\frac{OM}{OP} = \cos \theta, \quad \frac{MP}{OP} = \sin \theta \dots(1)$ <p>By Pythagoras theorem</p> $MP^2 + OM^2 = OP^2 \dots(2)$ <p>Dividing each term on both sides of (2) by <math>OP^2</math>, (<math>\because OP \neq 0</math>) we get,</p> $\frac{MP^2}{OP^2} + \frac{OM^2}{OP^2} = \frac{OP^2}{OP^2}$ $\Rightarrow \left(\frac{MP}{OP}\right)^2 + \left(\frac{OM}{OP}\right)^2 = \left(\frac{OP}{OP}\right)^2$ <p>From (1), <math>(\sin \theta)^2 + (\cos \theta)^2 = 1^2</math></p> <p>Hence <math>\sin^2 \theta + \cos^2 \theta = 1</math></p> <p>In the right angled <math>\Delta OMP</math>, we have</p> $\frac{MP}{OM} = \tan \theta, \quad \frac{OP}{OM} = \sec \theta \dots(3)$





	$1 + \tan^2 \theta = \sec^2 \theta$	<p>From (2), <math>MP^2 + OM^2 = OP^2</math></p> <p>Dividing each term on both sides of (2) by <math>OM^2</math>, (<math>\because OM \neq 0</math>) we get,</p> $\frac{MP^2}{OM^2} + \frac{OM^2}{OM^2} = \frac{OP^2}{OM^2}$ $\Rightarrow \left(\frac{MP}{OM}\right)^2 + \left(\frac{OM}{OM}\right)^2 = \left(\frac{OP}{OM}\right)^2$ <p>From (3), <math>(\tan \theta)^2 + 1^2 = (\sec \theta)^2</math></p> <p>Hence <math>1 + \tan^2 \theta = \sec^2 \theta</math>.</p>
	$1 + \cot^2 \theta = \operatorname{cosec}^2 \theta$	<p>In the right angled <math>\triangle OMP</math>, we have</p> $\frac{OM}{MP} = \cot \theta, \quad \frac{OP}{MP} = \operatorname{cosec} \theta \quad \dots(4)$ <p>From (2), <math>MP^2 + OM^2 = OP^2</math></p> <p>Dividing each term on both sides of (2) by <math>MP^2</math>, (<math>\because MP \neq 0</math>) we get,</p> $\frac{MP^2}{MP^2} + \frac{OM^2}{MP^2} = \frac{OP^2}{MP^2}$ $\Rightarrow \left(\frac{MP}{MP}\right)^2 + \left(\frac{OM}{MP}\right)^2 = \left(\frac{OP}{MP}\right)^2$ <p>From (4), <math>1^2 + (\cot \theta)^2 = (\operatorname{cosec} \theta)^2</math></p> <p>Hence, <math>1 + \cot^2 \theta = \operatorname{cosec}^2 \theta</math></p>

These identities can also be rewritten as follows.

Identity	Equal forms
$\sin^2 \theta + \cos^2 \theta = 1$	$\sin^2 \theta = 1 - \cos^2 \theta$ (or) $\cos^2 \theta = 1 - \sin^2 \theta$
$1 + \tan^2 \theta = \sec^2 \theta$	$\tan^2 \theta = \sec^2 \theta - 1$ (or) $\sec^2 \theta - \tan^2 \theta = 1$
$1 + \cot^2 \theta = \operatorname{cosec}^2 \theta$	$\cot^2 \theta = \operatorname{cosec}^2 \theta - 1$ (or) $\operatorname{cosec}^2 \theta - \cot^2 \theta = 1$

**Note**



Though the above identities are true for any angle  $\theta$ , we will consider the six trigonometric ratios only for  $0^\circ < \theta < 90^\circ$



### Activity 1

Take a white sheet of paper. Construct two perpendicular lines  $OX$ ,  $OY$  which meet at  $O$ , as shown in the Fig. 6.4(a).

Considering  $OX$  as  $X$  axis,  $OY$  as  $Y$  axis.

We will verify the values of  $\sin \theta$  and  $\cos \theta$  for certain angles  $\theta$ .

Let  $\theta = 30^\circ$

Construct a line segment  $OA$  of any length such that  $\angle AOX = 30^\circ$ , as shown in the Fig. 6.4(b).

Draw a perpendicular from  $A$  to  $OX$ , meeting at  $B$ .

Now using scale, measure the lengths of  $AB$ ,  $OB$  and  $OA$ .

Find the ratios  $\frac{AB}{OA}$ ,  $\frac{OB}{OA}$  and  $\frac{AB}{OB}$ .

What do you get? Can you compare these values with the trigonometric table values? What is your conclusion?

Carry out the same procedure for  $\theta = 45^\circ$  and  $\theta = 60^\circ$ .

What are your conclusions?

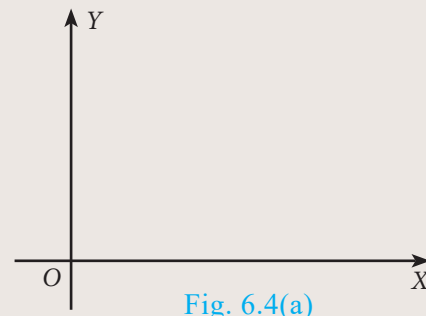

Fig. 6.4(a)

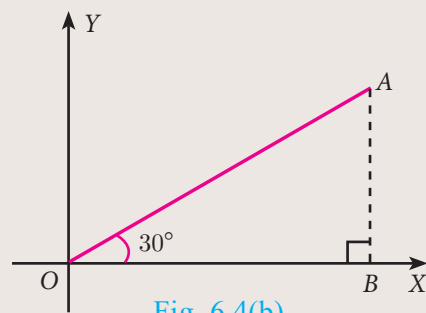

Fig. 6.4(b)

**Example 6.1** Prove that  $\tan^2 \theta - \sin^2 \theta = \tan^2 \theta \sin^2 \theta$

**Solution** 
$$\begin{aligned} \tan^2 \theta - \sin^2 \theta &= \tan^2 \theta - \frac{\sin^2 \theta}{\cos^2 \theta} \cdot \cos^2 \theta \\ &= \tan^2 \theta (1 - \cos^2 \theta) = \tan^2 \theta \sin^2 \theta \end{aligned}$$

**Example 6.2** Prove that  $\frac{\sin A}{1 + \cos A} = \frac{1 - \cos A}{\sin A}$

**Solution** 
$$\frac{\sin A}{1 + \cos A} = \frac{\sin A}{1 + \cos A} \times \frac{1 - \cos A}{1 - \cos A} \quad [\text{multiply numerator and denominator by the conjugate of } 1 + \cos A]$$

$$= \frac{\sin A(1 - \cos A)}{(1 + \cos A)(1 - \cos A)} = \frac{\sin A(1 - \cos A)}{1 - \cos^2 A}$$

$$= \frac{\sin A(1 - \cos A)}{\sin^2 A} = \frac{1 - \cos A}{\sin A}$$

**Example 6.3** Prove that  $1 + \frac{\cot^2 \theta}{1 + \operatorname{cosec} \theta} = \operatorname{cosec} \theta$

**Solution** 
$$1 + \frac{\cot^2 \theta}{1 + \operatorname{cosec} \theta} = 1 + \frac{\operatorname{cosec}^2 \theta - 1}{\operatorname{cosec} \theta + 1} \quad [\because \operatorname{cosec}^2 \theta - 1 = \cot^2 \theta]$$

$$= 1 + \frac{(\operatorname{cosec} \theta + 1)(\operatorname{cosec} \theta - 1)}{\operatorname{cosec} \theta + 1}$$

$$= 1 + (\operatorname{cosec} \theta - 1) = \operatorname{cosec} \theta$$



**Example 6.4** Prove that  $\sec \theta - \cos \theta = \tan \theta \sin \theta$

**Solution**

$$\begin{aligned} \sec \theta - \cos \theta &= \frac{1}{\cos \theta} - \cos \theta = \frac{1 - \cos^2 \theta}{\cos \theta} \\ &= \frac{\sin^2 \theta}{\cos \theta} \quad \left[ \because 1 - \cos^2 \theta = \sin^2 \theta \right] \\ &= \frac{\sin \theta}{\cos \theta} \times \sin \theta = \tan \theta \sin \theta \end{aligned}$$

**Example 6.5** Prove that  $\sqrt{\frac{1 + \cos \theta}{1 - \cos \theta}} = \operatorname{cosec} \theta + \cot \theta$

**Solution**

$$\begin{aligned} \sqrt{\frac{1 + \cos \theta}{1 - \cos \theta}} &= \sqrt{\frac{1 + \cos \theta}{1 - \cos \theta} \times \frac{1 + \cos \theta}{1 + \cos \theta}} \quad \left[ \text{multiply numerator and denominator} \right. \\ &\quad \left. \text{by the conjugate of } 1 - \cos \theta \right] \\ &= \sqrt{\frac{(1 + \cos \theta)^2}{1 - \cos^2 \theta}} = \frac{1 + \cos \theta}{\sqrt{\sin^2 \theta}} \quad \left[ \because \sin^2 \theta + \cos^2 \theta = 1 \right] \\ &= \frac{1 + \cos \theta}{\sin \theta} = \operatorname{cosec} \theta + \cot \theta \end{aligned}$$

**Example 6.6** Prove that  $\frac{\sec \theta}{\sin \theta} - \frac{\sin \theta}{\cos \theta} = \cot \theta$

**Solution**

$$\begin{aligned} \frac{\sec \theta}{\sin \theta} - \frac{\sin \theta}{\cos \theta} &= \frac{1}{\sin \theta \cos \theta} - \frac{\sin \theta}{\cos \theta} = \frac{1}{\sin \theta \cos \theta} - \frac{\sin \theta}{\cos \theta} \\ &= \frac{1 - \sin^2 \theta}{\sin \theta \cos \theta} = \frac{\cos^2 \theta}{\sin \theta \cos \theta} = \cot \theta \end{aligned}$$

**Example 6.7** Prove that  $\sin^2 A \cos^2 B + \cos^2 A \sin^2 B + \cos^2 A \cos^2 B + \sin^2 A \sin^2 B = 1$

**Solution**

$$\begin{aligned} \sin^2 A \cos^2 B + \cos^2 A \sin^2 B + \cos^2 A \cos^2 B + \sin^2 A \sin^2 B \\ &= \sin^2 A \cos^2 B + \sin^2 A \sin^2 B + \cos^2 A \sin^2 B + \cos^2 A \cos^2 B \\ &= \sin^2 A (\cos^2 B + \sin^2 B) + \cos^2 A (\sin^2 B + \cos^2 B) \\ &= \sin^2 A (1) + \cos^2 A (1) \quad (\because \sin^2 B + \cos^2 B = 1) \\ &= \sin^2 A + \cos^2 A = 1 \end{aligned}$$

**Example 6.8** If  $\cos \theta + \sin \theta = \sqrt{2} \cos \theta$ , then prove that  $\cos \theta - \sin \theta = \sqrt{2} \sin \theta$

**Solution**

Now,  $\cos \theta + \sin \theta = \sqrt{2} \cos \theta$ .

Squaring both sides,

$$\begin{aligned} (\cos \theta + \sin \theta)^2 &= (\sqrt{2} \cos \theta)^2 \\ \cos^2 \theta + \sin^2 \theta + 2 \sin \theta \cos \theta &= 2 \cos^2 \theta \end{aligned}$$

$$\begin{aligned}
 2 \cos^2 \theta - \cos^2 \theta - \sin^2 \theta &= 2 \sin \theta \cos \theta \\
 \cos^2 \theta - \sin^2 \theta &= 2 \sin \theta \cos \theta \\
 (\cos \theta + \sin \theta)(\cos \theta - \sin \theta) &= 2 \sin \theta \cos \theta \\
 \cos \theta - \sin \theta &= \frac{2 \sin \theta \cos \theta}{\cos \theta + \sin \theta} = \frac{2 \sin \theta \cos \theta}{\sqrt{2} \cos \theta} \quad [\because \cos \theta + \sin \theta = \sqrt{2} \cos \theta] \\
 &= \sqrt{2} \sin \theta
 \end{aligned}$$

Therefore,  $\cos \theta - \sin \theta = \sqrt{2} \sin \theta$ .

**Example 6.9** Prove that  $(\operatorname{cosec} \theta - \sin \theta)(\sec \theta - \cos \theta)(\tan \theta + \cot \theta) = 1$

**Solution**  $(\operatorname{cosec} \theta - \sin \theta)(\sec \theta - \cos \theta)(\tan \theta + \cot \theta)$

$$\begin{aligned}
 &= \left( \frac{1}{\sin \theta} - \sin \theta \right) \left( \frac{1}{\cos \theta} - \cos \theta \right) \left( \frac{\sin \theta}{\cos \theta} + \frac{\cos \theta}{\sin \theta} \right) \\
 &= \frac{1 - \sin^2 \theta}{\sin \theta} \times \frac{1 - \cos^2 \theta}{\cos \theta} \times \frac{\sin^2 \theta + \cos^2 \theta}{\sin \theta \cos \theta} \\
 &= \frac{\cos^2 \theta \sin^2 \theta \times 1}{\sin^2 \theta \cos^2 \theta} = 1
 \end{aligned}$$

**Example 6.10** Prove that  $\frac{\sin A}{1 + \cos A} + \frac{\sin A}{1 - \cos A} = 2 \operatorname{cosec} A$ .

**Solution**  $\frac{\sin A}{1 + \cos A} + \frac{\sin A}{1 - \cos A}$

$$\begin{aligned}
 &= \frac{\sin A(1 - \cos A) + \sin A(1 + \cos A)}{(1 + \cos A)(1 - \cos A)} \\
 &= \frac{\sin A - \sin A \cos A + \sin A + \sin A \cos A}{1 - \cos^2 A} \\
 &= \frac{2 \sin A}{1 - \cos^2 A} = \frac{2 \sin A}{\sin^2 A} = 2 \operatorname{cosec} A
 \end{aligned}$$

**Example 6.11** If  $\operatorname{cosec} \theta + \cot \theta = P$ , then prove that  $\cos \theta = \frac{P^2 - 1}{P^2 + 1}$

**Solution** Given  $\operatorname{cosec} \theta + \cot \theta = P$  ... (1)

$$\operatorname{cosec}^2 \theta - \cot^2 \theta = 1 \quad (\text{identity})$$

$$\operatorname{cosec} \theta - \cot \theta = \frac{1}{\operatorname{cosec} \theta + \cot \theta}$$

$$\operatorname{cosec} \theta - \cot \theta = \frac{1}{P} \quad \dots (2)$$

Adding (1) and (2) we get,  $2 \operatorname{cosec} \theta = P + \frac{1}{P}$

$$2 \operatorname{cosec} \theta = \frac{P^2 + 1}{P} \quad \dots (3)$$

Subtracting (2) from (1), we get,  $2 \cot \theta = P - \frac{1}{P}$

$$2 \cot \theta = \frac{P^2 - 1}{P} \quad \dots(4)$$

Dividing (4) by (3) we get,  $\frac{2 \cot \theta}{2 \operatorname{cosec} \theta} = \frac{P^2 - 1}{P} \times \frac{P}{P^2 + 1} \Rightarrow \cos \theta = \frac{P^2 - 1}{P^2 + 1}$

**Example 6.12** Prove that  $\tan^2 A - \tan^2 B = \frac{\sin^2 A - \sin^2 B}{\cos^2 A \cos^2 B}$

**Solution**  $\tan^2 A - \tan^2 B = \frac{\sin^2 A}{\cos^2 A} - \frac{\sin^2 B}{\cos^2 B}$

$$= \frac{\sin^2 A \cos^2 B - \sin^2 B \cos^2 A}{\cos^2 A \cos^2 B}$$

$$= \frac{\sin^2 A(1 - \sin^2 B) - \sin^2 B(1 - \sin^2 A)}{\cos^2 A \cos^2 B}$$

$$= \frac{\sin^2 A - \sin^2 A \sin^2 B - \sin^2 B + \sin^2 A \sin^2 B}{\cos^2 A \cos^2 B} = \frac{\sin^2 A - \sin^2 B}{\cos^2 A \cos^2 B}$$

**Example 6.13** Prove that  $\left( \frac{\cos^3 A - \sin^3 A}{\cos A - \sin A} \right) - \left( \frac{\cos^3 A + \sin^3 A}{\cos A + \sin A} \right) = 2 \sin A \cos A$

**Solution**  $\left( \frac{\cos^3 A - \sin^3 A}{\cos A - \sin A} \right) - \left( \frac{\cos^3 A + \sin^3 A}{\cos A + \sin A} \right)$

$$= \left( \frac{(\cos A - \sin A)(\cos^2 A + \sin^2 A + \cos A \sin A)}{\cos A - \sin A} \right) \left[ \begin{array}{l} \because a^3 - b^3 = (a - b)(a^2 + b^2 + ab) \\ a^3 + b^3 = (a + b)(a^2 + b^2 - ab) \end{array} \right]$$

$$- \left( \frac{(\cos A + \sin A)(\cos^2 A + \sin^2 A - \cos A \sin A)}{\cos A + \sin A} \right)$$

$$= (1 + \cos A \sin A) - (1 - \cos A \sin A)$$

$$= 2 \cos A \sin A$$

**Example 6.14** Prove that  $\frac{\sin A}{\sec A + \tan A - 1} + \frac{\cos A}{\operatorname{cosec} A + \cot A - 1} = 1$

**Solution**  $\frac{\sin A}{\sec A + \tan A - 1} + \frac{\cos A}{\operatorname{cosec} A + \cot A - 1}$

$$= \frac{\sin A(\operatorname{cosec} A + \cot A - 1) + \cos A(\sec A + \tan A - 1)}{(\sec A + \tan A - 1)(\operatorname{cosec} A + \cot A - 1)}$$

$$= \frac{\sin A \operatorname{cosec} A + \sin A \cot A - \sin A + \cos A \sec A + \cos A \tan A - \cos A}{(\sec A + \tan A - 1)(\operatorname{cosec} A + \cot A - 1)}$$

$$= \frac{1 + \cos A - \sin A + 1 + \sin A - \cos A}{\left( \frac{1}{\cos A} + \frac{\sin A}{\cos A} - 1 \right) \left( \frac{1}{\sin A} + \frac{\cos A}{\sin A} - 1 \right)}$$

$$\begin{aligned}
&= \frac{2}{\left(\frac{1 + \sin A - \cos A}{\cos A}\right)\left(\frac{1 + \cos A - \sin A}{\sin A}\right)} \\
&= \frac{2 \sin A \cos A}{(1 + \sin A - \cos A)(1 + \cos A - \sin A)} \\
&= \frac{2 \sin A \cos A}{[1 + (\sin A - \cos A)][1 - (\sin A - \cos A)]} = \frac{2 \sin A \cos A}{1 - (\sin A - \cos A)^2} \\
&= \frac{2 \sin A \cos A}{1 - (\sin^2 A + \cos^2 A - 2 \sin A \cos A)} = \frac{2 \sin A \cos A}{1 - (1 - 2 \sin A \cos A)} \\
&= \frac{2 \sin A \cos A}{1 - 1 + 2 \sin A \cos A} = \frac{2 \sin A \cos A}{2 \sin A \cos A} = 1.
\end{aligned}$$

**Example 6.15** Show that  $\left(\frac{1 + \tan^2 A}{1 + \cot^2 A}\right) = \left(\frac{1 - \tan A}{1 - \cot A}\right)^2$

**Solution**

<p><b>LHS</b></p> $ \begin{aligned} \left(\frac{1 + \tan^2 A}{1 + \cot^2 A}\right) &= \frac{1 + \tan^2 A}{1 + \frac{1}{\tan^2 A}} \\ &= \frac{1 + \tan^2 A}{\frac{\tan^2 A + 1}{\tan^2 A}} = \tan^2 A \dots (1) \end{aligned} $	<p><b>RHS</b></p> $ \begin{aligned} \left(\frac{1 - \tan A}{1 - \cot A}\right)^2 &= \left(\frac{1 - \tan A}{1 - \frac{1}{\tan A}}\right)^2 \\ &= \left(\frac{1 - \tan A}{\frac{\tan A - 1}{\tan A}}\right)^2 = (-\tan A)^2 = \tan^2 A \dots (2) \end{aligned} $
---	---

From (1) and (2),  $\left(\frac{1 + \tan^2 A}{1 + \cot^2 A}\right) = \left(\frac{1 - \tan A}{1 - \cot A}\right)^2$

**Example 6.16** Prove that  $\frac{(1 + \cot A + \tan A)(\sin A - \cos A)}{\sec^3 A - \operatorname{cosec}^3 A} = \sin^2 A \cos^2 A$

**Solution**

$$\begin{aligned}
&\frac{(1 + \cot A + \tan A)(\sin A - \cos A)}{\sec^3 A - \operatorname{cosec}^3 A} \\
&= \frac{\left(1 + \frac{\cos A}{\sin A} + \frac{\sin A}{\cos A}\right)(\sin A - \cos A)}{(\sec A - \operatorname{cosec} A)(\sec^2 A + \sec A \operatorname{cosec} A + \operatorname{cosec}^2 A)} \\
&= \frac{(\sin A \cos A + \cos^2 A + \sin^2 A)(\sin A - \cos A)}{(\sec A - \operatorname{cosec} A)\left(\frac{1}{\cos^2 A} + \frac{1}{\cos A \sin A} + \frac{1}{\sin^2 A}\right)}
\end{aligned}$$

$$\begin{aligned}
 &= \frac{(\sin A \cos A + 1) \left( \frac{\sin A}{\sin A \cos A} - \frac{\cos A}{\sin A \cos A} \right)}{(\sec A - \operatorname{cosec} A) \left( \frac{\sin^2 A + \sin A \cos A + \cos^2 A}{\sin^2 A \cos^2 A} \right)} \\
 &= \frac{(\sin A \cos A + 1)(\sec A - \operatorname{cosec} A)}{(\sec A - \operatorname{cosec} A)(1 + \sin A \cos A)} \times \sin^2 A \cos^2 A = \sin^2 A \cos^2 A
 \end{aligned}$$

**Example 6.17** If  $\frac{\cos^2 \theta}{\sin \theta} = p$  and  $\frac{\sin^2 \theta}{\cos \theta} = q$ , then prove that  $p^2 q^2 (p^2 + q^2 + 3) = 1$

**Solution** We have  $\frac{\cos^2 \theta}{\sin \theta} = p \dots(1)$  and  $\frac{\sin^2 \theta}{\cos \theta} = q \dots(2)$

$$\begin{aligned}
 p^2 q^2 (p^2 + q^2 + 3) &= \left( \frac{\cos^2 \theta}{\sin \theta} \right)^2 \left( \frac{\sin^2 \theta}{\cos \theta} \right)^2 \times \left[ \left( \frac{\cos^2 \theta}{\sin \theta} \right)^2 + \left( \frac{\sin^2 \theta}{\cos \theta} \right)^2 + 3 \right] \quad [\text{from (1) and (2)}] \\
 &= \left( \frac{\cos^4 \theta}{\sin^2 \theta} \right) \left( \frac{\sin^4 \theta}{\cos^2 \theta} \right) \times \left[ \frac{\cos^4 \theta}{\sin^2 \theta} + \frac{\sin^4 \theta}{\cos^2 \theta} + 3 \right] \\
 &= (\cos^2 \theta \times \sin^2 \theta) \times \left[ \frac{\cos^6 \theta + \sin^6 \theta + 3 \sin^2 \theta \cos^2 \theta}{\sin^2 \theta \cos^2 \theta} \right] \\
 &= \cos^6 \theta + \sin^6 \theta + 3 \sin^2 \theta \cos^2 \theta \\
 &= (\cos^2 \theta)^3 + (\sin^2 \theta)^3 + 3 \sin^2 \theta \cos^2 \theta \\
 &= [(\cos^2 \theta + \sin^2 \theta)^3 - 3 \cos^2 \theta \sin^2 \theta (\cos^2 \theta + \sin^2 \theta)] + 3 \sin^2 \theta \cos^2 \theta \\
 &= 1 - 3 \cos^2 \theta \sin^2 \theta (1) + 3 \cos^2 \theta \sin^2 \theta = 1
 \end{aligned}$$



### Progress Check

- The number of trigonometric ratios is \_\_\_\_\_.
- $1 - \cos^2 \theta$  is \_\_\_\_\_.
- $(\sec \theta + \tan \theta)(\sec \theta - \tan \theta)$  is \_\_\_\_\_.
- $(\cot \theta + \operatorname{cosec} \theta)(\cot \theta - \operatorname{cosec} \theta)$  is \_\_\_\_\_.
- $\cos 60^\circ \sin 30^\circ + \cos 30^\circ \sin 60^\circ$  is \_\_\_\_\_.
- $\tan 60^\circ \cos 60^\circ + \cot 60^\circ \sin 60^\circ$  is \_\_\_\_\_.
- $(\tan 45^\circ + \cot 45^\circ) + (\sec 45^\circ \operatorname{cosec} 45^\circ)$  is \_\_\_\_\_.
- (i)  $\sec \theta = \operatorname{cosec} \theta$  if  $\theta$  is \_\_\_\_\_. (ii)  $\cot \theta = \tan \theta$  if  $\theta$  is \_\_\_\_\_.



### Exercise 6.1

- Prove the following identities.
  - $\cot \theta + \tan \theta = \sec \theta \operatorname{cosec} \theta$
  - $\tan^4 \theta + \tan^2 \theta = \sec^4 \theta - \sec^2 \theta$
- Prove the following identities.
  - $\frac{1 - \tan^2 \theta}{\cot^2 \theta - 1} = \tan^2 \theta$
  - $\frac{\cos \theta}{1 + \sin \theta} = \sec \theta - \tan \theta$

3. Prove the following identities.

$$(i) \sqrt{\frac{1 + \sin \theta}{1 - \sin \theta}} = \sec \theta + \tan \theta \quad (ii) \sqrt{\frac{1 + \sin \theta}{1 - \sin \theta}} + \sqrt{\frac{1 - \sin \theta}{1 + \sin \theta}} = 2 \sec \theta$$

4. Prove the following identities.

$$(i) \sec^6 \theta = \tan^6 \theta + 3 \tan^2 \theta \sec^2 \theta + 1$$

$$(ii) (\sin \theta + \sec \theta)^2 + (\cos \theta + \operatorname{cosec} \theta)^2 = 1 + (\sec \theta + \operatorname{cosec} \theta)^2$$

5. Prove the following identities.

$$(i) \sec^4 \theta (1 - \sin^4 \theta) - 2 \tan^2 \theta = 1 \quad (ii) \frac{\cot \theta - \cos \theta}{\cot \theta + \cos \theta} = \frac{\operatorname{cosec} \theta - 1}{\operatorname{cosec} \theta + 1}$$

6. Prove the following identities.

$$(i) \frac{\sin A - \sin B}{\cos A + \cos B} + \frac{\cos A - \cos B}{\sin A + \sin B} = 0 \quad (ii) \frac{\sin^3 A + \cos^3 A}{\sin A + \cos A} + \frac{\sin^3 A - \cos^3 A}{\sin A - \cos A} = 2$$

7. (i) If  $\sin \theta + \cos \theta = \sqrt{3}$ , then prove that  $\tan \theta + \cot \theta = 1$ .

$$(ii) \text{ If } \sqrt{3} \sin \theta - \cos \theta = 0, \text{ then show that } \tan 3\theta = \frac{3 \tan \theta - \tan^3 \theta}{1 - 3 \tan^2 \theta}$$

8. (i) If  $\frac{\cos \alpha}{\cos \beta} = m$  and  $\frac{\cos \alpha}{\sin \beta} = n$ , then prove that  $(m^2 + n^2) \cos^2 \beta = n^2$

$$(ii) \text{ If } \cot \theta + \tan \theta = x \text{ and } \sec \theta - \cos \theta = y, \text{ then prove that } (x^2 y)^{\frac{2}{3}} - (xy^2)^{\frac{2}{3}} = 1$$

9. (i) If  $\sin \theta + \cos \theta = p$  and  $\sec \theta + \operatorname{cosec} \theta = q$ , then prove that  $q(p^2 - 1) = 2p$

$$(ii) \text{ If } \sin \theta (1 + \sin^2 \theta) = \cos^2 \theta, \text{ then prove that } \cos^6 \theta - 4 \cos^4 \theta + 8 \cos^2 \theta = 4$$

10. If  $\frac{\cos \theta}{1 + \sin \theta} = \frac{1}{a}$ , then prove that  $\frac{a^2 - 1}{a^2 + 1} = \sin \theta$

### 6.3 Heights and Distances

In this section, we will see how trigonometry is used for finding the heights and distances of various objects without actually measuring them. For example, the height of a tower, mountain, building or tree, distance of a ship from a light house, width of a river, etc. can be determined by using knowledge of trigonometry. The process of finding **Heights** and **Distances** is the best example of applying trigonometry in real-life situations. We would explain these applications through some examples. Before studying methods to find heights and distances, we should understand some basic definitions.

#### Line of Sight

The **line of sight** is the line drawn from the eye of an observer to the point in the object viewed by the observer.

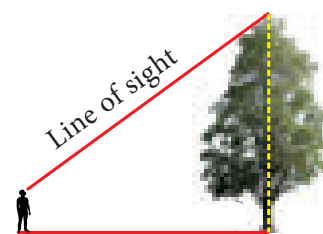

Fig. 6.5





### Theodolite

Theodolite is an instrument which is used in measuring the angle between an object and the eye of the observer. A theodolite consists of two graduated wheels placed at right angles to each other and a telescope. The wheels are used for the measurement of horizontal and vertical angles. The angle to the desired point is measured by positioning the telescope towards that point. The angle can be read on the telescope scale.

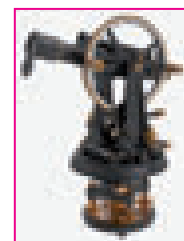

Fig. 6.6

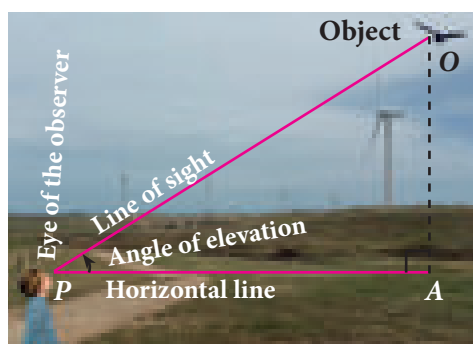

Fig. 6.7

### Angle of Elevation

The **angle of elevation** is an angle formed by the **line of sight** with the **horizontal** when the point being viewed is **above** the horizontal level. That is, the case when we raise our head to look at the object. (see Fig. 6.7)

### Angle of Depression

The **angle of depression** is an angle formed by the **line of sight** with the **horizontal** when the point is **below** the horizontal level. That is, the case when we lower our head to look at the point being viewed. (see Fig. 6.8)

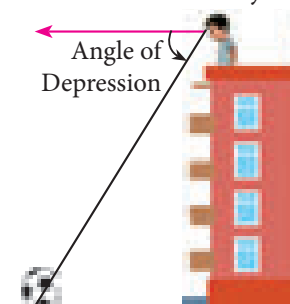

Fig. 6.8

### Clinometer

The angle of elevation and depression are usually measured by a device called clinometer.

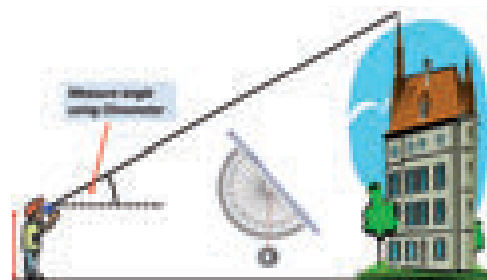

Fig. 6.9

#### Note

➤ From a given point, when height of an object increases the angle of elevation increases.

If  $h_1 > h_2$  then  $\alpha > \beta$

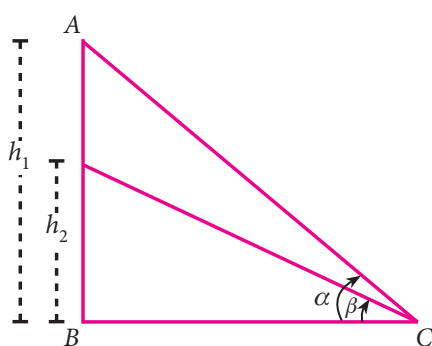

Fig. 6.10(a)

➤ The angle of elevation increases as we move towards the foot of the vertical object like tower or building.

If  $d_2 < d_1$  then  $\beta > \alpha$

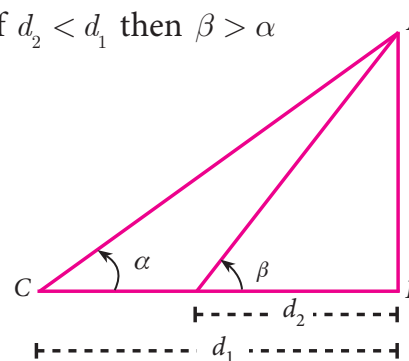

Fig. 6.10(b)



**Activity 2**

Representation of situations through right triangles. Draw a figure to illustrate the situation.

Situations	Draw a figure
A tower stands vertically on the ground. From a point on the ground, which is 20m away from the foot of the tower, the angle of elevation of the top of the tower is found to be $45^\circ$ .	<p style="text-align: center;">Fig. 6.11</p>
An observer of 1.8 m tall is 25.2 m away from a chimney. The angle of elevation of the top of the chimney from her eyes is $45^\circ$ .	.....
From a point $P$ on the ground the angle of elevation of the top of a 20 m tall building is $30^\circ$ . A flag is hoisted at the top of the building and the angle of elevation of the top of the flagstaff from $P$ is $55^\circ$ .	.....
The shadow of a tower standing on a level ground is found to be 40 m longer when the Sun's altitude is $30^\circ$ than when it is $60^\circ$ .	.....

**6.3.1 Problems involving Angle of Elevation**

In this section, we try to solve problems when Angle of elevation are given.

**Example 6.18**

Calculate  $\angle BAC$  in the given triangles. ( $\tan 38.7^\circ = 0.8011$ ,  $\tan 69.4^\circ = 2.6604$ )

**Solution**

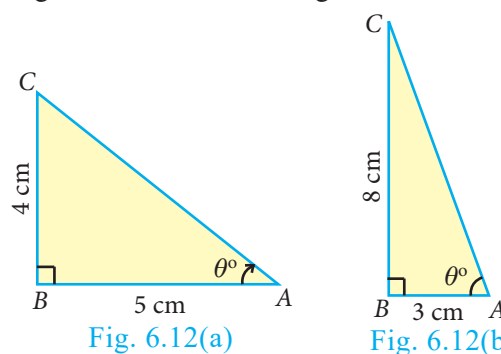

(i) In the right angled  $\triangle ABC$  [see Fig.6.12(a)]

$$\tan \theta = \frac{\text{opposite side}}{\text{adjacent side}} = \frac{4}{5}$$

$$\tan \theta = 0.8$$

$$\Rightarrow \theta = 38.7^\circ (\because \tan 38.7^\circ = 0.8011)$$

$$\therefore \angle BAC = 38.7^\circ$$

(ii) In the right angled  $\triangle ABC$  [see Fig.6.12(b)]

$$\tan \theta = \frac{8}{3}$$

$$\tan \theta = 2.66$$

$$\Rightarrow \theta = 69.4^\circ (\because \tan 69.4^\circ = 2.6604)$$

$$\therefore \angle BAC = 69.4^\circ$$



**Example 6.19** A tower stands vertically on the ground. From a point on the ground, which is 48 m away from the foot of the tower, the angle of elevation of the top of the tower is  $30^\circ$ . Find the height of the tower.

**Solution** Let  $PQ$  be the height of the tower.

Take  $PQ = h$  and  $QR$  is the distance between the tower and the point  $R$ . In the right angled  $\Delta PQR$ ,  $\angle PRQ = 30^\circ$

$$\tan \theta = \frac{PQ}{QR}$$

$$\tan 30^\circ = \frac{h}{48} \Rightarrow \frac{1}{\sqrt{3}} = \frac{h}{48} \Rightarrow h = 16\sqrt{3}$$

Therefore, the height of the tower is  $16\sqrt{3}$  m

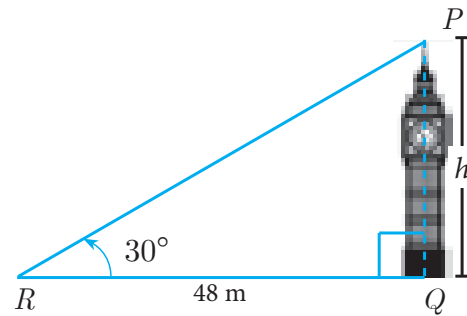

Fig. 6.13

**Example 6.20** A kite is flying at a height of 75 m above the ground. The string attached to the kite is temporarily tied to a point on the ground. The inclination of the string with the ground is  $60^\circ$ . Find the length of the string, assuming that there is no slack in the string.

**Solution** Let  $AB$  be the height of the kite above the ground. Then,  $AB = 75$ .

Let  $AC$  be the length of the string.

In the right angled  $\Delta ABC$ ,  $\angle ACB = 60^\circ$

$$\sin \theta = \frac{AB}{AC}$$

$$\sin 60^\circ = \frac{75}{AC}$$

$$\Rightarrow \frac{\sqrt{3}}{2} = \frac{75}{AC} \Rightarrow AC = \frac{150}{\sqrt{3}} = 50\sqrt{3}$$

Hence, the length of the string is  $50\sqrt{3}$  m.

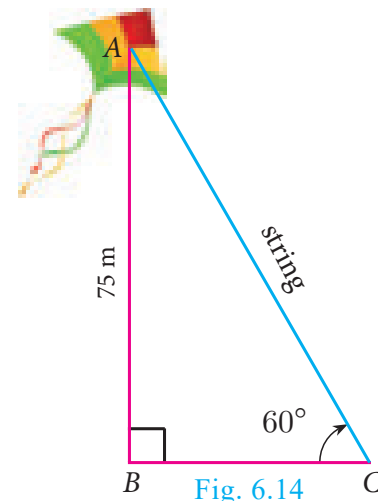

Fig. 6.14

**Example 6.21** Two ships are sailing in the sea on either sides of a lighthouse. The angle of elevation of the top of the lighthouse as observed from the ships are  $30^\circ$  and  $45^\circ$  respectively. If the lighthouse is 200 m high, find the distance between the two ships. ( $\sqrt{3} = 1.732$ )

**Solution** Let  $AB$  be the lighthouse. Let  $C$  and  $D$  be the positions of the two ships.

Then,  $AB = 200$  m.

$\angle ACB = 30^\circ$ ,  $\angle ADB = 45^\circ$

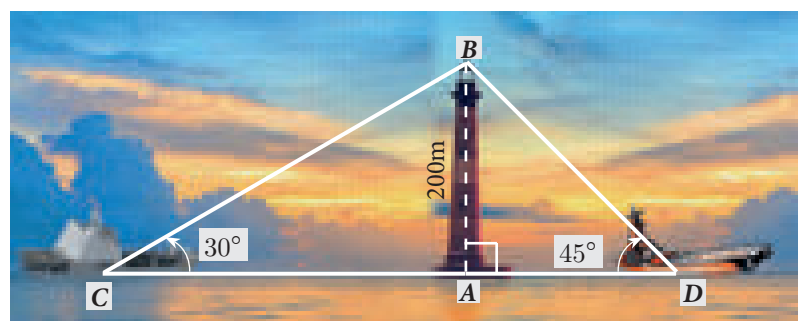

Fig. 6.15

In the right angled  $\triangle BAC$ ,  $\tan 30^\circ = \frac{AB}{AC}$

$$\frac{1}{\sqrt{3}} = \frac{200}{AC} \Rightarrow AC = 200\sqrt{3} \quad \dots(1)$$

In the right angled  $\triangle BAD$ ,  $\tan 45^\circ = \frac{AB}{AD}$

$$1 = \frac{200}{AD} \Rightarrow AD = 200 \quad \dots(2)$$

Now,  $CD = AC + AD = 200\sqrt{3} + 200$  [by (1) and (2)]

$$CD = 200(\sqrt{3} + 1) = 200 \times 2.732 = 546.4$$

Distance between two ships is 546.4 m.

**Example 6.22** From a point on the ground, the angles of elevation of the bottom and top of a tower fixed at the top of a 30 m high building are  $45^\circ$  and  $60^\circ$  respectively. Find the height of the tower. ( $\sqrt{3} = 1.732$ )

**Solution** Let  $AC$  be the height of the tower.

Let  $AB$  be the height of the building.

Then,  $AC = h$  metres,  $AB = 30$  m

In the right angled  $\triangle CBP$ ,  $\angle CPB = 60^\circ$

$$\tan \theta = \frac{BC}{BP}$$

$$\tan 60^\circ = \frac{AB + AC}{BP} \Rightarrow \sqrt{3} = \frac{30 + h}{BP} \quad \dots(1)$$

In the right angled  $\triangle ABP$ ,  $\angle APB = 45^\circ$

$$\tan \theta = \frac{AB}{BP}$$

$$\tan 45^\circ = \frac{30}{BP} \Rightarrow BP = 30 \quad \dots(2)$$

Substituting (2) in (1), we get  $\sqrt{3} = \frac{30 + h}{30}$

$$h = 30(\sqrt{3} - 1) = 30(1.732 - 1) = 30(0.732) = 21.96$$

Hence, the height of the tower is 21.96 m.

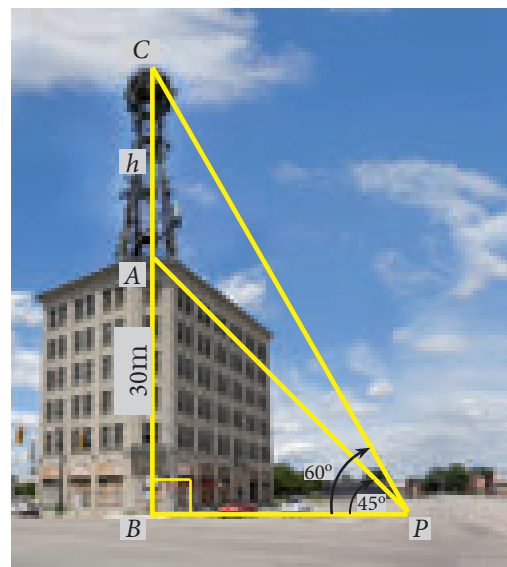

Fig. 6.16

**Example 6.23** A TV tower stands vertically on a bank of a canal. The tower is watched from a point on the other bank directly opposite to it. The angle of elevation of the top of the tower is  $58^\circ$ . From another point 20 m away from this point on the line joining this point to the foot of the tower, the angle of elevation of the top of the tower is  $30^\circ$ . Find the height of the tower and the width of the canal. ( $\tan 58^\circ = 1.6003$ )



**Solution**

Let  $AB$  be the height of the TV tower.

$CD = 20$  m.

Let  $BC$  be the width of the canal.

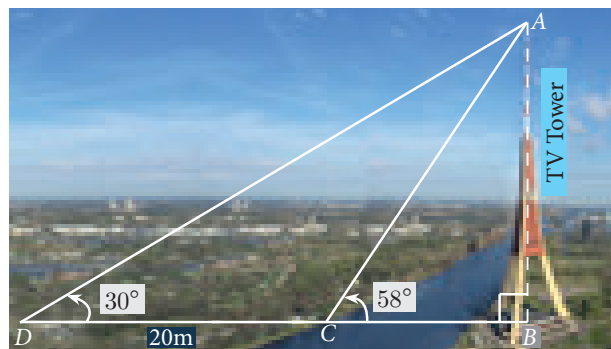

Fig. 6.17

In the right angled  $\triangle ABC$ ,  $\tan 58^\circ = \frac{AB}{BC}$

$$1.6003 = \frac{AB}{BC} \quad \dots(1)$$

In the right angled  $\triangle ABD$ ,  $\tan 30^\circ = \frac{AB}{BD} = \frac{AB}{BC + CD}$

$$\frac{1}{\sqrt{3}} = \frac{AB}{BC + 20} \quad \dots(2)$$

Dividing (1) by (2) we get,  $\frac{1.6003}{\frac{1}{\sqrt{3}}} = \frac{BC + 20}{BC}$

$$BC = \frac{20}{1.7717} = 11.29 \text{ m} \quad \dots(3)$$

$$1.6003 = \frac{AB}{11.29} \text{ [from (1) and (3)]}$$

$$AB = 18.07$$

Hence, the height of the tower is 18.07 m and the width of the canal is 11.29 m.

**Example 6.24** An aeroplane sets off from  $G$  on a bearing of  $24^\circ$  towards  $H$ , a point 250 km away. At  $H$  it changes course and heads towards  $J$  deviates further by  $55^\circ$  and a distance of 180 km away.

- (i) How far is  $H$  to the North of  $G$ ?
- (ii) How far is  $H$  to the East of  $G$ ?
- (iii) How far is  $J$  to the North of  $H$ ?
- (iv) How far is  $J$  to the East of  $H$ ?

$$\begin{pmatrix} \sin 24^\circ = 0.4067 & \sin 11^\circ = 0.1908 \\ \cos 24^\circ = 0.9135 & \cos 11^\circ = 0.9816 \end{pmatrix}$$

**Solution**

(i) In the right angled  $\triangle GOH$ ,  $\cos 24^\circ = \frac{OG}{GH}$

$$0.9135 = \frac{OG}{250}; \quad OG = 228.38 \text{ km}$$

Distance of  $H$  to the North of  $G = 228.38$  km

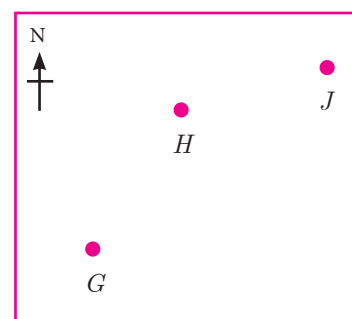

Fig. 6.18 (a)

(ii) In the right angled  $\triangle GOH$ ,

$$\sin 24^\circ = \frac{OH}{GH}$$

$$0.4067 = \frac{OH}{250} ; OH = 101.68$$

Distance of  $H$  to the East of

$$G = 101.68 \text{ km}$$

(iii) In the right angled  $\triangle HIJ$ ,

$$\sin 11^\circ = \frac{IJ}{HJ}$$

$$0.1908 = \frac{IJ}{180} ; IJ = 34.34 \text{ km}$$

Distance of  $J$  to the North of  $H = 34.34 \text{ km}$

(iv) In the right angled  $\triangle HIJ$ ,

$$\cos 11^\circ = \frac{HI}{HJ}$$

$$0.9816 = \frac{HI}{180} ; HI = 176.69 \text{ km}$$

Distance of  $J$  to the East of  $H = 176.69 \text{ km}$

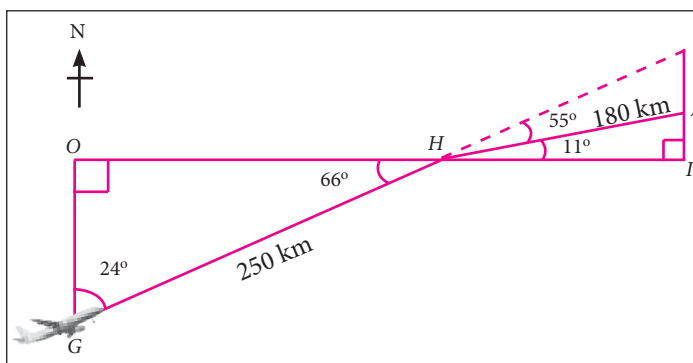

Fig. 6.18 (b)

**Example 6.25** As shown in the figure, two trees are standing on flat ground. The angle of elevation of the top of both the trees from a point  $X$  on the ground is  $40^\circ$ . If the horizontal distance between  $X$  and the smaller tree is 8 m and the distance of the top of the two trees is 20 m, calculate

- the distance between the point  $X$  and the top of the smaller tree.
- the horizontal distance between the two trees.  
( $\cos 40^\circ = 0.7660$ )

**Solution** Let  $AB$  be the height of the bigger tree and  $CD$  be the height of the smaller tree and  $X$  is the point on the ground.

(i) In the right angled  $\triangle XCD$ ,  $\cos 40^\circ = \frac{CX}{XD}$

$$XD = \frac{8}{0.7660} = 10.44 \text{ m}$$

Therefore, the distance between  $X$  and top of the smaller tree =  $XD = 10.44 \text{ m}$

(ii) In the right angled  $\triangle XAB$ ,

$$\cos 40^\circ = \frac{AX}{BX} = \frac{AC + CX}{BD + DX}$$

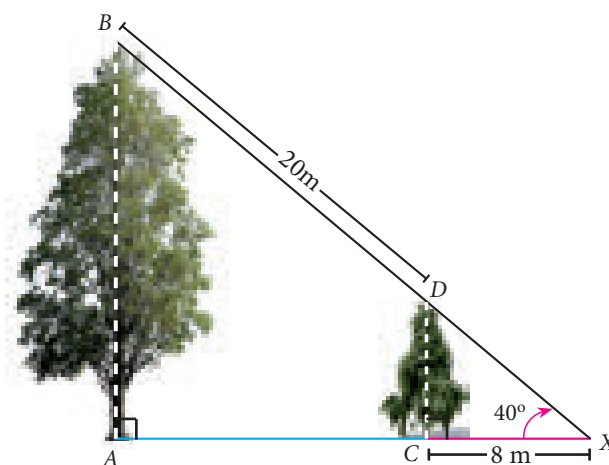

Fig. 6.19



$$0.7660 = \frac{AC + 8}{20 + 10.44} \Rightarrow AC = 23.32 - 8 = 15.32 \text{ m}$$

Therefore, the horizontal distance between two trees =  $AC = 15.32 \text{ m}$

### Thinking Corner



1. What type of triangle is used to calculate heights and distances?
2. When the height of the building and distances from the foot of the building is given, which trigonometric ratio is used to find the angle of elevation?
3. If the line of sight and angle of elevation is given, then which trigonometric ratio is used
  - (i) to find the height of the building
  - (ii) to find the distance from the foot of the building.



### Exercise 6.2

1. Find the angle of elevation of the top of a tower from a point on the ground, which is 30 m away from the foot of a tower of height  $10\sqrt{3}$  m.
2. A road is flanked on either side by continuous rows of houses of height  $4\sqrt{3}$  m with no space in between them. A pedestrian is standing on the median of the road facing a row house. The angle of elevation from the pedestrian to the top of the house is  $30^\circ$ . Find the width of the road.
3. To a man standing outside his house, the angles of elevation of the top and bottom of a window are  $60^\circ$  and  $45^\circ$  respectively. If the height of the man is 180 cm and if he is 5 m away from the wall, what is the height of the window? ( $\sqrt{3} = 1.732$ )
4. A statue 1.6 m tall stands on the top of a pedestal. From a point on the ground, the angle of elevation of the top of the statue is  $60^\circ$  and from the same point the angle of elevation of the top of the pedestal is  $40^\circ$ . Find the height of the pedestal. ( $\tan 40^\circ = 0.8391$ ,  $\sqrt{3} = 1.732$ )
5. A flag pole of height ' $h$ ' metres is on the top of the hemispherical dome of radius ' $r$ ' metres. A man is standing 7 m away from the dome. Seeing the top of the pole at an angle  $45^\circ$  and moving 5 m away from the dome and seeing the bottom of the pole at an angle  $30^\circ$ . Find (i) the height of the pole (ii) radius of the dome. ( $\sqrt{3} = 1.732$ )

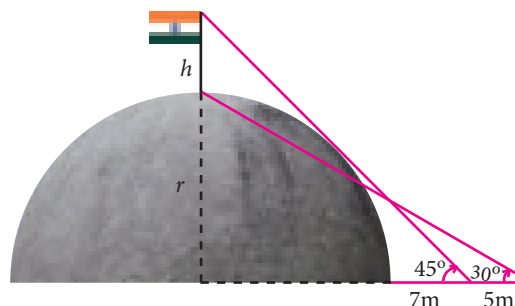

6. The top of a 15 m high tower makes an angle of elevation of  $60^\circ$  with the bottom of an electronic pole and angle of elevation of  $30^\circ$  with the top of the pole. What is the height of the electric pole?

### 6.3.2 Problems involving Angle of Depression

#### Note

In this section, we try to solve problems when Angles of depression are given.

Angle of Depression and Angle of Elevation are equal because they are alternative angles.

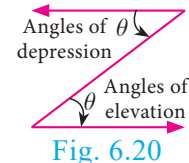

Fig. 6.20

**Example 6.26** A player sitting on the top of a tower of height 20 m observes the angle of depression of a ball lying on the ground as  $60^\circ$ . Find the distance between the foot of the tower and the ball. ( $\sqrt{3} = 1.732$ )

**Solution** Let  $BC$  be the height of the tower and  $A$  be the position of the ball lying on the ground. Then,

$$BC = 20 \text{ m and } \angle XCA = 60^\circ = \angle CAB$$

$$\text{Let } AB = x \text{ metres.}$$

In the right angled  $\triangle ABC$ ,

$$\tan 60^\circ = \frac{BC}{AB}$$

$$\sqrt{3} = \frac{20}{x}$$

$$x = \frac{20 \times \sqrt{3}}{\sqrt{3} \times \sqrt{3}} = \frac{20 \times 1.732}{3} = 11.55 \text{ m.}$$

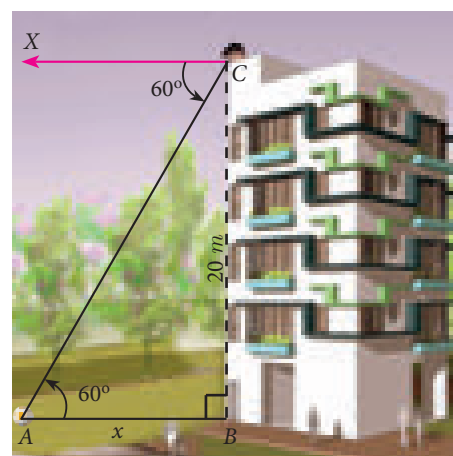

Fig. 6.21

Hence, the distance between the foot of the tower and the ball is 11.55 m.

**Example 6.27** The horizontal distance between two buildings is 140 m. The angle of depression of the top of the first building when seen from the top of the second building is  $30^\circ$ . If the height of the first building is 60 m, find the height of the second building. ( $\sqrt{3} = 1.732$ )

**Solution** The height of the first building

$$AB = 60 \text{ m. Now, } AB = MD = 60 \text{ m}$$

Let the height of the second building

$$CD = h. \text{ Distance } BD = 140 \text{ m}$$

$$\text{Now, } AM = BD = 140 \text{ m}$$

From the diagram,

$$\angle XCA = 30^\circ = \angle CAM$$

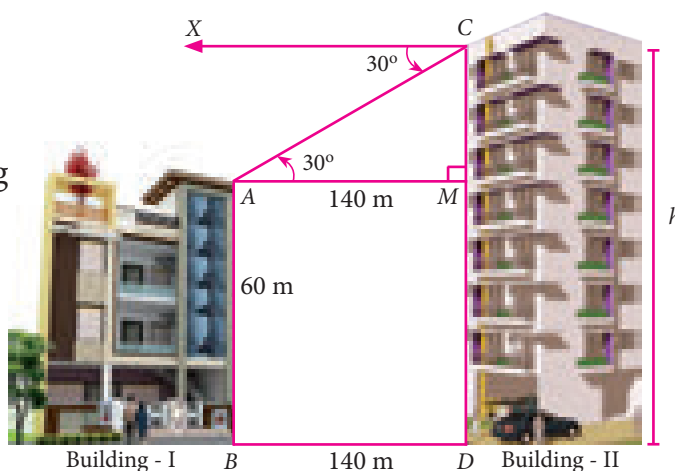

Fig. 6.22





In the right angled  $\triangle AMC$ ,  $\tan 30^\circ = \frac{CM}{AM}$

$$\frac{1}{\sqrt{3}} = \frac{CM}{140}$$

$$CM = \frac{140}{\sqrt{3}} = \frac{140\sqrt{3}}{3}$$

$$= \frac{140 \times 1.732}{3}$$

$$CM = 80.83$$

Now,  $h = CD = CM + MD = 80.83 + 60 = 140.83$

Therefore, the height of the second building is 140.83 m

**Example 6.28** From the top of a tower 50 m high, the angles of depression of the top and bottom of a tree are observed to be  $30^\circ$  and  $45^\circ$  respectively. Find the height of the tree. ( $\sqrt{3} = 1.732$ )

**Solution** The height of the tower  $AB = 50$  m

Let the height of the tree  $CD = y$  and  $BD = x$

From the diagram,  $\angle XAC = 30^\circ = \angle ACM$  and  $\angle XAD = 45^\circ = \angle ADB$

In the right angled  $\triangle ABD$ ,

$$\tan 45^\circ = \frac{AB}{BD}$$

$$1 = \frac{50}{x} \Rightarrow x = 50 \text{ m}$$

In the right angled  $\triangle AMC$ ,

$$\tan 30^\circ = \frac{AM}{CM}$$

$$\frac{1}{\sqrt{3}} = \frac{AM}{50} \quad [\because DB = CM]$$

$$AM = \frac{50}{\sqrt{3}} = \frac{50\sqrt{3}}{3} = \frac{50 \times 1.732}{3} = 28.87 \text{ m.}$$

Therefore, height of the tree =  $CD = MB = AB - AM = 50 - 28.87 = 21.13$  m

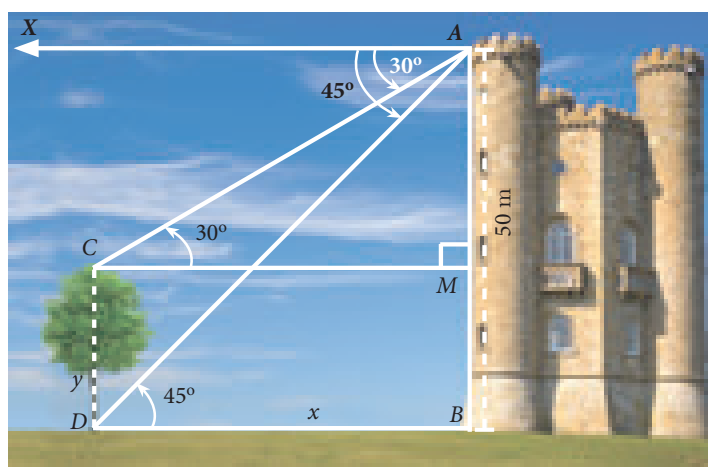

Fig. 6.23

**Example 6.29** As observed from the top of a 60 m high lighthouse from the sea level, the angles of depression of two ships are  $28^\circ$  and  $45^\circ$ . If one ship is exactly behind the other on the same side of the lighthouse, find the distance between the two ships. ( $\tan 28^\circ = 0.5317$ )

**Solution** Let the observer on the lighthouse  $CD$  be at  $D$ .

Height of the lighthouse  $CD = 60$  m

From the diagram,

$$\angle XDA = 28^\circ = \angle DAC \text{ and}$$

$$\angle XDB = 45^\circ = \angle DBC$$

In the right angled  $\triangle DCB$ ,  $\tan 45^\circ = \frac{DC}{BC}$

$$1 = \frac{60}{BC} \Rightarrow BC = 60 \text{ m}$$

In the right angled  $\triangle DCA$ ,  $\tan 28^\circ = \frac{DC}{AC}$

$$0.5317 = \frac{60}{AC} \Rightarrow AC = \frac{60}{0.5317} = 112.85$$

Distance between the two ships  $AB = AC - BC = 52.85$  m

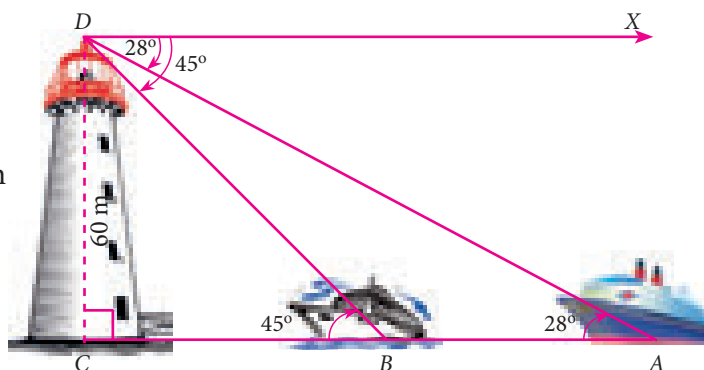

Fig. 6.24

**Example 6.30** A man is watching a boat speeding away from the top of a tower. The boat makes an angle of depression of  $60^\circ$  with the man's eye when at a distance of 200 m from the tower. After 10 seconds, the angle of depression becomes  $45^\circ$ . What is the approximate speed of the boat (in km / hr), assuming that it is sailing in still water? ( $\sqrt{3} = 1.732$ )

**Solution** Let  $AB$  be the tower.

Let  $C$  and  $D$  be the positions of the boat.

From the diagram,

$$\angle XAC = 60^\circ = \angle ACB \text{ and}$$

$$\angle XAD = 45^\circ = \angle ADB, BC = 200 \text{ m}$$

In the right angled  $\triangle ABC$ ,  $\tan 60^\circ = \frac{AB}{BC}$

$$\Rightarrow \sqrt{3} = \frac{AB}{200}$$

we get  $AB = 200\sqrt{3} \dots(1)$

In the right angled  $\triangle ABD$ ,  $\tan 45^\circ = \frac{AB}{BD}$

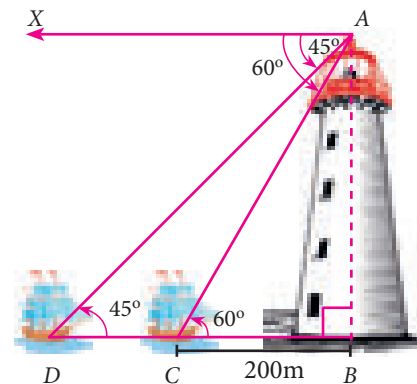

Fig. 6.25





$$\Rightarrow 1 = \frac{200\sqrt{3}}{BD} \quad [\text{by (1)}]$$

we get,  $BD = 200\sqrt{3}$

Now,  $CD = BD - BC$

$$CD = 200\sqrt{3} - 200 = 200(\sqrt{3} - 1) = 146.4$$

It is given that the distance  $CD$  is covered in 10 seconds.

That is, the distance of 146.4 m is covered in 10 seconds.

Therefore, speed of the boat =  $\frac{\text{distance}}{\text{time}}$

$$= \frac{146.4}{10} = 14.64 \text{ m/s} \Rightarrow 14.64 \times \frac{3600}{1000} \text{ km/hr} = 52.704 \text{ km/hr}$$



### Exercise 6.3

1. From the top of a rock  $50\sqrt{3}$  m high, the angle of depression of a car on the ground is observed to be  $30^\circ$ . Find the distance of the car from the rock.
2. The horizontal distance between two buildings is 70 m. The angle of depression of the top of the first building when seen from the top of the second building is  $45^\circ$ . If the height of the second building is 120 m, find the height of the first building.
3. From the top of the tower 60 m high the angles of depression of the top and bottom of a vertical lamp post are observed to be  $38^\circ$  and  $60^\circ$  respectively. Find the height of the lamp post. ( $\tan 38^\circ = 0.7813$ ,  $\sqrt{3} = 1.732$ )
4. An aeroplane at an altitude of 1800 m finds that two boats are sailing towards it in the same direction. The angles of depression of the boats as observed from the aeroplane are  $60^\circ$  and  $30^\circ$  respectively. Find the distance between the two boats. ( $\sqrt{3} = 1.732$ )
5. From the top of a lighthouse, the angle of depression of two ships on the opposite sides of it are observed to be  $30^\circ$  and  $60^\circ$ . If the height of the lighthouse is  $h$  meters and the line joining the ships passes through the foot of the lighthouse, show that the distance between the ships is  $\frac{4h}{\sqrt{3}}$  m.
6. A lift in a building of height 90 feet with transparent glass walls is descending from the top of the building. At the top of the building, the angle of depression to a fountain in the garden is  $60^\circ$ . Two minutes later, the angle of depression reduces to  $30^\circ$ . If the fountain is  $30\sqrt{3}$  feet from the entrance of the lift, find the speed of the lift which is descending.

### 6.3.3 Problems involving Angle of Elevation and Depression

Let us consider the following situation.

A man standing at a top of lighthouse located in a beach watch on aeroplane flying above the sea. At the same instant he watch a ship sailing in the sea. The angle with which he watch the plane correspond to angle of elevation and the angle of watching the ship corresponding to angle of depression. This is one example were one oberseves both angle of elevation and angle of depression.

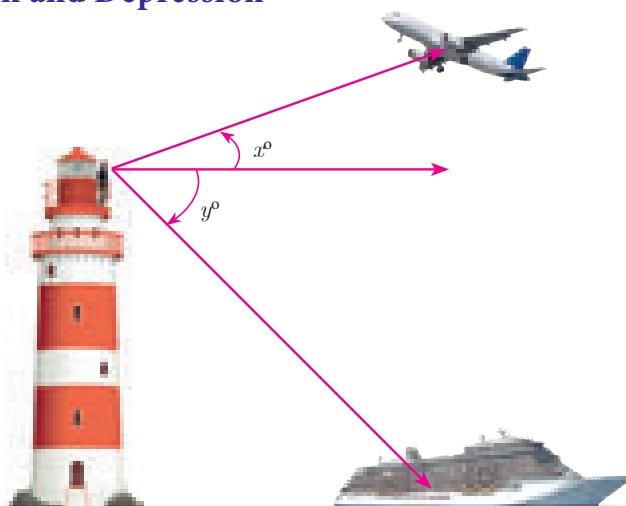

Fig. 6.26

In the Fig.6.26,  $x^\circ$  is the angle of elevation and  $y^\circ$  is the angle of depression.

In this section, we try to solve problems when Angles of elevation and depression are given.

**Example 6.31** From the top of a 12 m high building, the angle of elevation of the top of a cable tower is  $60^\circ$  and the angle of depression of its foot is  $30^\circ$ . Determine the height of the tower.

**Solution** As shown in Fig.6.27,  $OA$  is the building,  $O$  is the point of observation on the top of the building  $OA$ . Then,  $OA = 12$  m.

$PP'$  is the cable tower with  $P$  as the top and  $P'$  as the bottom.

Then the angle of elevation of  $P$ ,  $\angle MOP = 60^\circ$ .

And the angle of depression of  $P'$ ,  $\angle MOP' = 30^\circ$ .

Suppose, height of the cable tower  $PP' = h$  metres.

Through  $O$ , draw  $OM \perp PP'$

$$MP = PP' - MP' = h - OA = h - 12$$

In the right angled  $\triangle OMP$ ,  $\frac{MP}{OM} = \tan 60^\circ$

$$\Rightarrow \frac{h - 12}{OM} = \sqrt{3}$$

$$OM = \frac{h - 12}{\sqrt{3}} \quad \dots(1)$$

In the right angled  $\triangle OMP'$ ,  $\frac{MP'}{OM} = \tan 30^\circ$

$$\Rightarrow \frac{12}{OM} = \frac{1}{\sqrt{3}}$$

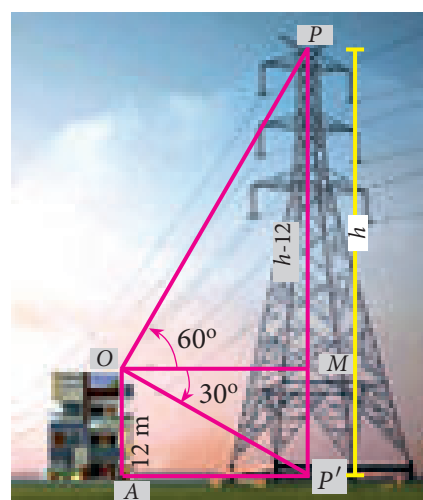

Fig. 6.27





$$OM = 12\sqrt{3} \quad \dots(2)$$

From (1) and (2) we have,  $\frac{h-12}{\sqrt{3}} = 12\sqrt{3}$

$$\Rightarrow h - 12 = 12\sqrt{3} \times \sqrt{3} \quad \text{we get, } h = 48$$

Hence, the required height of the cable tower is 48 m.

**Example 6.32** A pole 5 m high is fixed on the top of a tower. The angle of elevation of the top of the pole observed from a point 'A' on the ground is  $60^\circ$  and the angle of depression to the point 'A' from the top of the tower is  $45^\circ$ . Find the height of the tower. ( $\sqrt{3} = 1.732$ )

**Solution** Let  $BC$  be the height of the tower and  $CD$  be the height of the pole.

Let 'A' be the point of observation.

Let  $BC = x$  and  $AB = y$ .

From the diagram,

$$\angle BAD = 60^\circ \text{ and } \angle XCA = 45^\circ = \angle BAC$$

In the right angled  $\triangle ABC$ ,  $\tan 45^\circ = \frac{BC}{AB}$

$$\Rightarrow 1 = \frac{x}{y} \Rightarrow x = y \quad \dots(1)$$

In the right angled  $\triangle ABD$ ,  $\tan 60^\circ = \frac{BD}{AB} = \frac{BC + CD}{AB}$

$$\Rightarrow \sqrt{3} = \frac{x+5}{y} \Rightarrow \sqrt{3}y = x+5$$

we get,  $\sqrt{3}x = x+5$  [From (1)]

$$x = \frac{5}{\sqrt{3}-1} = \frac{5}{\sqrt{3}-1} \times \frac{\sqrt{3}+1}{\sqrt{3}+1} = \frac{5(1.732+1)}{2} = 6.83$$

Hence, height of the tower is 6.83 m.

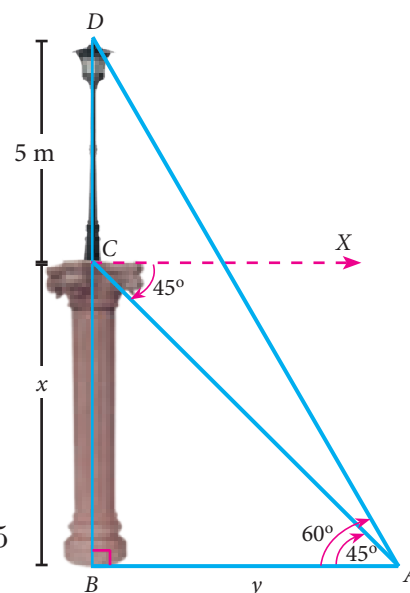

Fig. 6.28

**Example 6.33** From a window ( $h$  metres high above the ground) of a house in a street, the angles of elevation and depression of the top and the foot of another house on the opposite side of the street are  $\theta_1$  and  $\theta_2$  respectively. Show that the height of the opposite house is  $h \left( 1 + \frac{\cot \theta_2}{\cot \theta_1} \right)$ .

**Solution** Let  $W$  be the point on the window where the angles of elevation and depression are measured. Let  $PQ$  be the house on the opposite side.

Then  $WA$  is the width of the street.

Height of the window =  $h$  metres  
 =  $AQ$  ( $WR = AQ$ )

Let  $PA = x$  metres.

In the right angled  $\triangle PAW$ ,  $\tan \theta_1 = \frac{AP}{AW}$

$$\Rightarrow \tan \theta_1 = \frac{x}{AW}$$

$$AW = \frac{x}{\tan \theta_1}$$

we get,  $AW = x \cot \theta_1 \dots(1)$

In the right angled  $\triangle QAW$ ,  $\tan \theta_2 = \frac{AQ}{AW}$

$$\Rightarrow \tan \theta_2 = \frac{h}{AW}$$

we get,  $AW = h \cot \theta_2 \dots(2)$

From (1) and (2) we get,  $x \cot \theta_1 = h \cot \theta_2$

$$\Rightarrow x = h \frac{\cot \theta_2}{\cot \theta_1}$$

Therefore, height of the opposite house =  $PA + AQ = x + h = h \frac{\cot \theta_2}{\cot \theta_1} + h = h \left( 1 + \frac{\cot \theta_2}{\cot \theta_1} \right)$

Hence Proved.

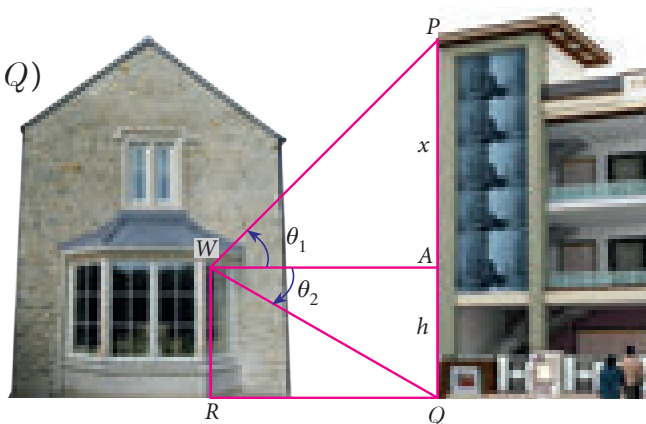

Fig. 6.29

**Thinking Corner**

What is the minimum number of measurements required to determine the height or distance or angle of elevation?



**Progress Check**

1. The line drawn from the eye of an observer to the point of object is \_\_\_\_\_.
2. Which instrument is used in measuring the angle between an object and the eye of the observer?
3. When the line of sight is above the horizontal level, the angle formed is \_\_\_\_\_.
4. The angle of elevation \_\_\_\_\_ as we move towards the foot of the vertical object (tower).
5. When the line of sight is below the horizontal level, the angle formed is \_\_\_\_\_.



**Exercise 6.4**

1. From the top of a tree of height 13 m the angle of elevation and depression of the top and bottom of another tree are  $45^\circ$  and  $30^\circ$  respectively. Find the height of the second tree. ( $\sqrt{3} = 1.732$ )



- A man is standing on the deck of a ship, which is 40 m above water level. He observes the angle of elevation of the top of a hill as  $60^\circ$  and the angle of depression of the base of the hill as  $30^\circ$ . Calculate the distance of the hill from the ship and the height of the hill. ( $\sqrt{3} = 1.732$ )
- If the angle of elevation of a cloud from a point 'h' metres above a lake is  $\theta_1$  and the angle of depression of its reflection in the lake is  $\theta_2$ . Prove that the height that the cloud is located from the ground is  $\frac{h(\tan \theta_1 + \tan \theta_2)}{\tan \theta_2 - \tan \theta_1}$ .
- The angle of elevation of the top of a cell phone tower from the foot of a high apartment is  $60^\circ$  and the angle of depression of the foot of the tower from the top of the apartment is  $30^\circ$ . If the height of the apartment is 50 m, find the height of the cell phone tower. According to radiations control norms, the minimum height of a cell phone tower should be 120 m. State if the height of the above mentioned cell phone tower meets the radiation norms.
- The angles of elevation and depression of the top and bottom of a lamp post from the top of a 66 m high apartment are  $60^\circ$  and  $30^\circ$  respectively. Find
  - The height of the lamp post.
  - The difference between height of the lamp post and the apartment.
  - The distance between the lamp post and the apartment. ( $\sqrt{3} = 1.732$ )

- Three villagers  $A$ ,  $B$  and  $C$  can see each other using telescope across a valley. The horizontal distance between  $A$  and  $B$  is 8 km and the horizontal distance between  $B$  and  $C$  is 12 km. The angle of depression of  $B$  from  $A$  is  $20^\circ$  and the angle of elevation of  $C$  from  $B$  is  $30^\circ$ . Calculate : (i) the vertical height between  $A$  and  $B$ . (ii) the vertical height between  $B$  and  $C$ . ( $\tan 20^\circ = 0.3640$ ,  $\sqrt{3} = 1.732$ )

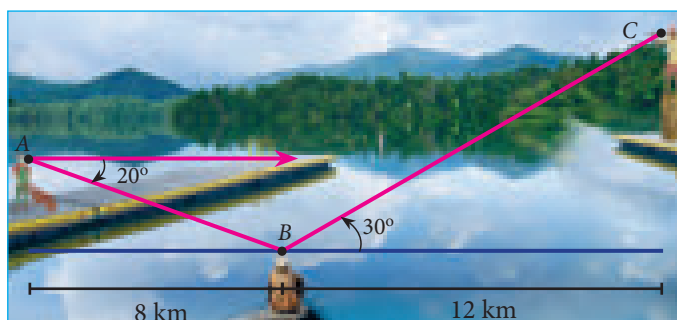

### Exercise 6.5



### Multiple choice questions

- The value of  $\sin^2 \theta + \frac{1}{1 + \tan^2 \theta}$  is equal to
 

(A) $\tan^2 \theta$	(B) 1	(C) $\cot^2 \theta$	(D) 0
---------------------	-------	---------------------	-------
- $\tan \theta \operatorname{cosec}^2 \theta - \tan \theta$  is equal to
 

(A) $\sec \theta$	(B) $\cot^2 \theta$	(C) $\sin \theta$	(D) $\cot \theta$
-------------------	---------------------	-------------------	-------------------
- If  $(\sin \alpha + \operatorname{cosec} \alpha)^2 + (\cos \alpha + \sec \alpha)^2 = k + \tan^2 \alpha + \cot^2 \alpha$ , then the value of  $k$  is equal to
 

(A) 9	(B) 7	(C) 5	(D) 3
-------	-------	-------	-------



4. If  $\sin \theta + \cos \theta = a$  and  $\sec \theta + \operatorname{cosec} \theta = b$ , then the value of  $b(a^2 - 1)$  is equal to  
 (A)  $2a$  (B)  $3a$  (C)  $0$  (D)  $2ab$
5. If  $5x = \sec \theta$  and  $\frac{5}{x} = \tan \theta$ , then  $x^2 - \frac{1}{x^2}$  is equal to  
 (A)  $25$  (B)  $\frac{1}{25}$  (C)  $5$  (D)  $1$
6. If  $\sin \theta = \cos \theta$ , then  $2 \tan^2 \theta + \sin^2 \theta - 1$  is equal to  
 (A)  $\frac{-3}{2}$  (B)  $\frac{3}{2}$  (C)  $\frac{2}{3}$  (D)  $\frac{-2}{3}$
7. If  $x = a \tan \theta$  and  $y = b \sec \theta$  then  
 (A)  $\frac{y^2}{b^2} - \frac{x^2}{a^2} = 1$  (B)  $\frac{x^2}{a^2} - \frac{y^2}{b^2} = 1$  (C)  $\frac{x^2}{a^2} + \frac{y^2}{b^2} = 1$  (D)  $\frac{x^2}{a^2} - \frac{y^2}{b^2} = 0$
8.  $(1 + \tan \theta + \sec \theta)(1 + \cot \theta - \operatorname{cosec} \theta)$  is equal to  
 (A)  $0$  (B)  $1$  (C)  $2$  (D)  $-1$
9.  $a \cot \theta + b \operatorname{cosec} \theta = p$  and  $b \cot \theta + a \operatorname{cosec} \theta = q$  then  $p^2 - q^2$  is equal to  
 (A)  $a^2 - b^2$  (B)  $b^2 - a^2$  (C)  $a^2 + b^2$  (D)  $b - a$
10. If the ratio of the height of a tower and the length of its shadow is  $\sqrt{3} : 1$ , then the angle of elevation of the sun has measure  
 (A)  $45^\circ$  (B)  $30^\circ$  (C)  $90^\circ$  (D)  $60^\circ$
11. The electric pole subtends an angle of  $30^\circ$  at a point on the same level as its foot. At a second point 'b' metres above the first, the depression of the foot of the pole is  $60^\circ$ . The height of the pole (in metres) is equal to  
 (A)  $\sqrt{3} b$  (B)  $\frac{b}{3}$  (C)  $\frac{b}{2}$  (D)  $\frac{b}{\sqrt{3}}$
12. A tower is 60 m high. Its shadow is  $x$  metres shorter when the sun's altitude is  $45^\circ$  than when it has been  $30^\circ$ , then  $x$  is equal to  
 (A) 41.92 m (B) 43.92 m (C) 43 m (D) 45.6 m
13. The angle of depression of the top and bottom of 20 m tall building from the top of a multistoried building are  $30^\circ$  and  $60^\circ$  respectively. The height of the multistoried building and the distance between two buildings (in metres) is  
 (A) 20,  $10\sqrt{3}$  (B) 30,  $5\sqrt{3}$  (C) 20, 10 (D) 30,  $10\sqrt{3}$
14. Two persons are standing 'x' metres apart from each other and the height of the first person is double that of the other. If from the middle point of the line joining their feet an observer finds the angular elevations of their tops to be complementary, then the height of the shorter person (in metres) is  
 (A)  $\sqrt{2} x$  (B)  $\frac{x}{2\sqrt{2}}$  (C)  $\frac{x}{\sqrt{2}}$  (D)  $2x$



15. The angle of elevation of a cloud from a point  $h$  metres above a lake is  $\beta$ . The angle of depression of its reflection in the lake is  $45^\circ$ . The height of location of the cloud from the lake is

(A)  $\frac{h(1 + \tan \beta)}{1 - \tan \beta}$       (B)  $\frac{h(1 - \tan \beta)}{1 + \tan \beta}$       (C)  $h \tan(45^\circ - \beta)$       (D) none of these

### Unit Exercise - 6



- Prove that (i)  $\cot^2 A \left( \frac{\sec A - 1}{1 + \sin A} \right) + \sec^2 A \left( \frac{\sin A - 1}{1 + \sec A} \right) = 0$       (ii)  $\frac{\tan^2 \theta - 1}{\tan^2 \theta + 1} = 1 - 2 \cos^2 \theta$
- Prove that  $\left( \frac{1 + \sin \theta - \cos \theta}{1 + \sin \theta + \cos \theta} \right)^2 = \frac{1 - \cos \theta}{1 + \cos \theta}$
- If  $x \sin^3 \theta + y \cos^3 \theta = \sin \theta \cos \theta$  and  $x \sin \theta = y \cos \theta$ , then prove that  $x^2 + y^2 = 1$ .
- If  $a \cos \theta - b \sin \theta = c$ , then prove that  $(a \sin \theta + b \cos \theta) = \pm \sqrt{a^2 + b^2 - c^2}$ .
- A bird is sitting on the top of a 80 m high tree. From a point on the ground, the angle of elevation of the bird is  $45^\circ$ . The bird flies away horizontally in such away that it remained at a constant height from the ground. After 2 seconds, the angle of elevation of the bird from the same point is  $30^\circ$ . Determine the speed at which the bird flies. ( $\sqrt{3} = 1.732$ )
- An aeroplane is flying parallel to the Earth's surface at a speed of 175 m/sec and at a height of 600 m. The angle of elevation of the aeroplane from a point on the Earth's surface is  $37^\circ$ . After what period of time does the angle of elevation increase to  $53^\circ$ ? ( $\tan 53^\circ = 1.3270$ ,  $\tan 37^\circ = 0.7536$ )
- A bird is flying from  $A$  towards  $B$  at an angle of  $35^\circ$ , a point 30 km away from  $A$ . At  $B$  it changes its course of flight and heads towards  $C$  on a bearing of  $48^\circ$  and distance 32 km away.
  - How far is  $B$  to the North of  $A$ ?
  - How far is  $B$  to the West of  $A$ ?
  - How far is  $C$  to the North of  $B$ ?
  - How far is  $C$  to the East of  $B$ ?
 ( $\sin 55^\circ = 0.8192$ ,  $\cos 55^\circ = 0.5736$ ,  $\sin 42^\circ = 0.6691$ ,  $\cos 42^\circ = 0.7431$ )
- Two ships are sailing in the sea on either side of the lighthouse. The angles of depression of two ships as observed from the top of the lighthouse are  $60^\circ$  and  $45^\circ$  respectively. If the distance between the ships is  $200 \left( \frac{\sqrt{3} + 1}{\sqrt{3}} \right)$  metres, find the height of the lighthouse.
- A building and a statue are in opposite side of a street from each other 35 m apart. From a point on the roof of building the angle of elevation of the top of statue is  $24^\circ$  and the angle of depression of base of the statue is  $34^\circ$ . Find the height of the statue. ( $\tan 24^\circ = 0.4452$ ,  $\tan 34^\circ = 0.6745$ )



### Points to Remember

- An equation involving trigonometric ratios of an angle is called a trigonometric identity if it is true for all values of the angle.
- Trigonometric identities
  - (i)  $\sin^2 \theta + \cos^2 \theta = 1$       (ii)  $1 + \tan^2 \theta = \sec^2 \theta$       (iii)  $1 + \cot^2 \theta = \operatorname{cosec}^2 \theta$
- The line of sight is the line drawn from the eye of an observer to the point in the object viewed by the observer.
- The angle of elevation of an object viewed is the angle formed by the line of sight with the horizontal when it is above the horizontal level.
- The angle of depression of an object viewed is the angle formed by the line of sight with the horizontal when it is below the horizontal level.
- The height or length of an object or distance between two distant objects can be determined with the help of trigonometric ratios.

### ICT CORNER



#### ICT 6.1

**Step 1:** Open the Browser type the URL Link given below (or) Scan the QR Code. Chapter named “Trigonometry” will open. Select the work sheet “Basic Identity”

**Step 2:** In the given worksheet you can change the triangle by dragging the point “B”. Check the identity for each angle of the right angled triangle in the unit circle.

Step 1

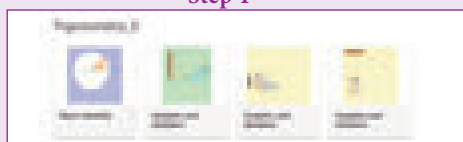

Step 2

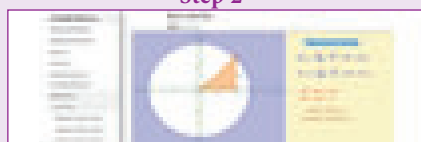

Expected results



#### ICT 6.2

**Step 1:** Open the Browser type the URL Link given below (or) Scan the QR Code. Chapter named “Trigonometry” will open. Select the work sheet “Heights and distance problem-1”

**Step 2:** In the given worksheet you can change the Question by clicking on “New Problem”. Move the slider, to view the steps. Workout the problem yourself and verify the answer.

Step 1

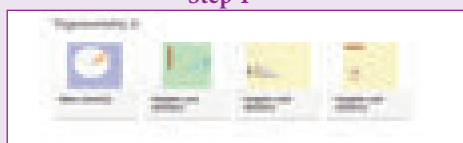

Step 2

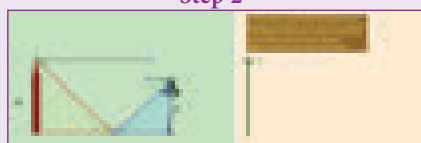

Expected results

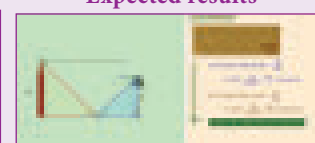

You can repeat the same steps for other activities

<https://www.geogebra.org/m/jfr2zzgy#chapter/356196>

or Scan the QR Code.

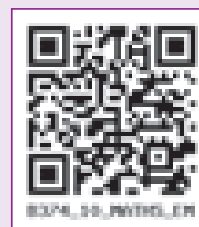

# MENSURATION

*"Nature is an infinite sphere of which the centre is everywhere and the circumference nowhere".*  
- Blaise Pascal

Pappus, born at Alexandria, Egypt is the last of the great Greek geometers. Pappus major work 'Synagoge' or 'The Mathematical Collection' is a collection of mathematical writings in eight books.

He described the principles of levers, pulleys, wedges, axles and screws. These concepts are widely applied in Physics and modern Engineering Science.

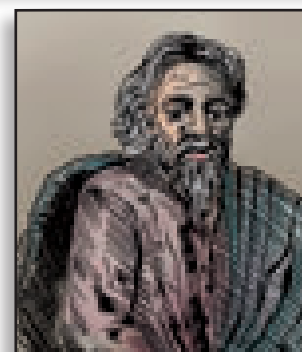

**Pappus**  
290 - 350 AD(CE)



## Learning Outcomes

- To determine the surface area and volume of cylinder, cone, sphere, hemisphere and frustum.
- To compute volume and surface area of combined solids.
- To solve problems involving conversion of solids from one shape to another with no change in volume.



## 7.1 Introduction

The ancient cultures throughout the world sought the idea of measurements for satisfying their daily needs. For example, they had to know how much area of crops needed to be grown in a given region; how much could a container hold? etc. These questions were very important for making decisions in agriculture and trade. They needed efficient and compact way of doing this. It is for this reason, mathematicians thought of applying geometry to real life situations to attain useful results.

This was the reason for the origin of mensuration. Thus, mensuration can be thought as applied geometry.

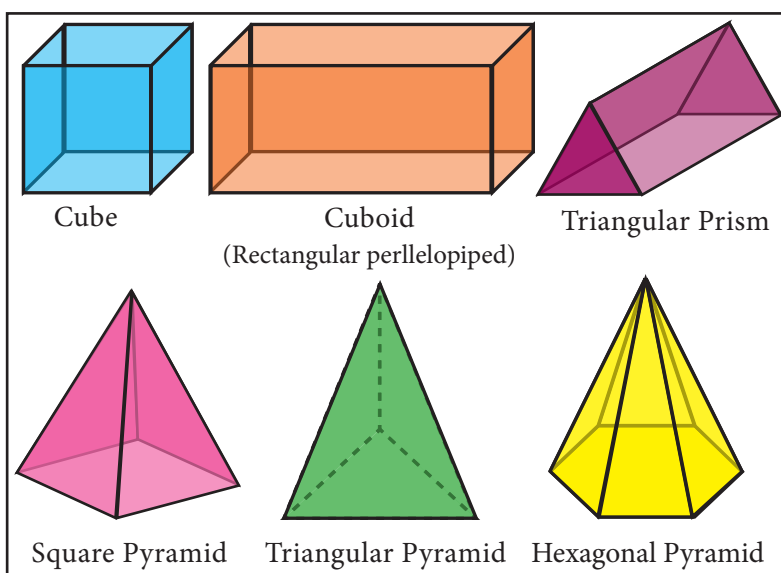

Fig. 7.1





We are already familiar with the areas of plane figures like square, rectangle, triangle, circle etc. These figures are called 2-dimensional shapes as they can be drawn in a plane. But most of the objects which we come across in our daily life cannot be represented in a plane. For example, tubes, water tanks, bricks, ice-cream cones, football etc. These objects are called solid shapes or 3-dimensional shapes.

We often see solids like cube, cuboid, prism and pyramid. For three dimensional objects measurements like surface area and volume exist.

In this chapter, we shall study about the surface area and volume of some of the standard solid shapes such as cylinder, cone, sphere, hemisphere and frustum.



## 7.2 Surface Area

Surface area is the measurement of all exposed area of a solid object.

### 7.2.1 Right Circular Cylinder

Observe the given figures in Fig.7.2 and identify the shape.

These objects resemble the shape of a cylinder.

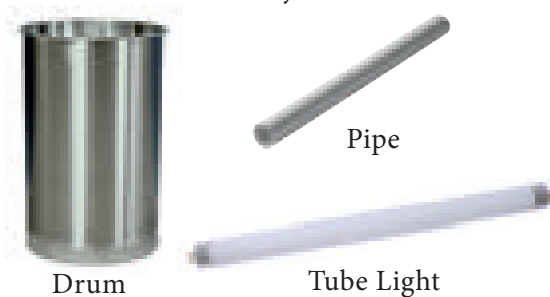

Fig. 7.2

**Definition:** A right circular cylinder is a solid generated by the revolution of a rectangle about one of its sides as axis.

If the axis is perpendicular to the radius then the cylinder is called a right circular cylinder. In the Fig.7.3,  $AB = h$  represent the height and  $AD = r$  represent the radius of the cylinder.

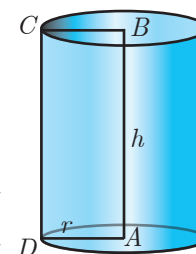

Fig. 7.3

A solid cylinder is an object bounded by two circular plane surfaces and a curved surface. The area between the two circular bases is called its 'Lateral Surface Area' (L.S.A.) or 'Curved Surface Area' (C.S.A.).

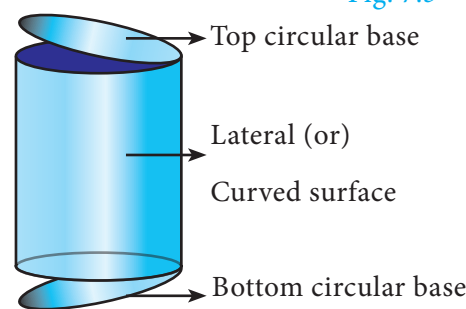

Fig. 7.4

### Formation of a Right Circular Cylinder – Demonstration

- (i) Take a rectangle sheet of a paper of length  $l$  and breadth  $b$ .
- (ii) Revolve the paper about one of its sides, say  $b$  to complete a full rotation (without overlapping).
- (iii) The shape thus formed will be a right circular cylinder whose circumference of the base is  $l$  and the height is  $b$ .

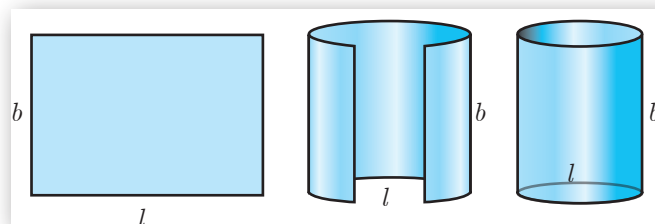

Fig. 7.5



## Surface Area of a Right Circular Cylinder

### (i) Curved surface area

$$\begin{aligned}
 \text{Curved surface area (C.S.A.) of a right circular cylinder} &= \text{Area of the corresponding rectangle} \\
 &= l \times b \\
 &= 2\pi r \times h \quad (\because l \text{ is the circumference} \\
 &= 2\pi r h \quad \text{of the base, } b \text{ is the height)} \text{ [see Fig. 7.5]}
 \end{aligned}$$

$$\text{C.S.A. of a right circular cylinder} = 2\pi r h \text{ sq. units.}$$

### (ii) Total surface area

Total surface area refers to the sum of areas of the curved surface area and the two circular regions at the top and bottom.

$$\begin{aligned}
 \text{That is, total surface area (T.S.A.) of right circular cylinder} &= \text{C.S.A} + \text{Area of top circular region} \\
 &\quad + \text{Area of bottom circular region.} \\
 &= 2\pi r h + \pi r^2 + \pi r^2 \quad (\text{Refer Fig.7.4}) \\
 &= 2\pi r h + 2\pi r^2 \\
 &= 2\pi r (h + r)
 \end{aligned}$$

$$\text{T.S.A. of a right circular cylinder} = 2\pi r (h + r) \text{ sq. units}$$

**Note**



- We always consider  $\pi = \frac{22}{7}$ , unless otherwise stated.
- The term 'surface area' refers to 'total surface area'.

**Example 7.1** A cylindrical drum has a height of 20 cm and base radius of 14 cm. Find its curved surface area and the total surface area.

**Solution** Given that, height of the cylinder  $h = 20$  cm ; radius  $r = 14$  cm

$$\text{Now, C.S.A. of the cylinder} = 2\pi r h \text{ sq. units}$$

$$\text{C.S.A. of the cylinder} = 2 \times \frac{22}{7} \times 14 \times 20 = 2 \times 22 \times 2 \times 20 = 1760 \text{ cm}^2$$

$$\text{T.S.A. of the cylinder} = 2\pi r (h + r) \text{ sq. units}$$

$$= 2 \times \frac{22}{7} \times 14 \times (20 + 14) = 2 \times \frac{22}{7} \times 14 \times 34$$

$$= 2992 \text{ cm}^2$$

Therefore, C.S.A. = 1760 cm<sup>2</sup> and T.S.A. = 2992 cm<sup>2</sup>

**Example 7.2** The curved surface area of a right circular cylinder of height 14 cm is  $88 \text{ cm}^2$ . Find the diameter of the cylinder.

**Solution** Given that, C.S.A. of the cylinder =  $88 \text{ sq. cm}$

$$\begin{aligned} 2\pi rh &= 88 \\ 2 \times \frac{22}{7} \times r \times 14 &= 88 \quad (h=14 \text{ cm}) \\ 2r &= \frac{88 \times 7}{22 \times 14} = 2 \end{aligned}$$

Therefore, diameter = 2 cm

**Example 7.3** A garden roller whose length is 3 m long and whose diameter is 2.8 m is rolled to level a garden. How much area will it cover in 8 revolutions?

**Solution** Given that, diameter  $d = 2.8 \text{ m}$  and height = 3 m

$$\text{radius } r = 1.4 \text{ m}$$

$$\begin{aligned} \text{Area covered in one revolution} &= \text{curved surface area of the cylinder} \\ &= 2\pi rh \text{ sq. units} \\ &= 2 \times \frac{22}{7} \times 1.4 \times 3 = 26.4 \end{aligned}$$

$$\text{Area covered in 1 revolution} = 26.4 \text{ m}^2$$

$$\text{Area covered in 8 revolutions} = 8 \times 26.4 = 211.2$$

Therefore, area covered is  $211.2 \text{ m}^2$



Fig. 7.6

### Thinking Corner

1. When ' $h$ ' coins each of radius ' $r$ ' units and thickness 1 unit is stacked one upon the other, what would be the solid object you get? Also find its C.S.A.
2. When the radius of a cylinder is double its height, find the relation between its C.S.A. and base area.
3. Two circular cylinders are formed by rolling two rectangular aluminum sheets each of dimensions 12 m length and 5 m breadth, one by rolling along its length and the other along its width. Find the ratio of their curved surface areas.

### 7.2.2 Hollow Cylinder

An object bounded by two co-axial cylinders of the same height and different radii is called a 'hollow cylinder'.

Let  $R$  and  $r$  be the outer and inner radii of the cylinder. Let  $h$  be its height.

$$\begin{aligned} \text{C.S.A of the hollow cylinder} &= \text{outer C.S.A. of the cylinder} \\ &\quad + \text{inner C.S.A. of the cylinder} \\ &= 2\pi Rh + 2\pi rh \end{aligned}$$

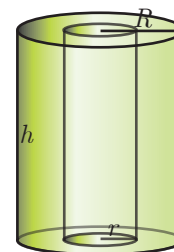

Fig. 7.7

$$\text{C.S.A of a hollow cylinder} = 2\pi(R + r)h \text{ sq. units}$$

$$\begin{aligned}\text{T.S.A. of the hollow cylinder} &= \text{C.S.A.} + \text{Area of two rings at the top and bottom.} \\ &= 2\pi(R + r)h + 2\pi(R^2 - r^2)\end{aligned}$$

$$\text{T.S.A. of a hollow cylinder} = 2\pi(R + r)(R - r + h) \text{ sq. units}$$

**Example 7.4** If one litre of paint covers  $10 \text{ m}^2$ , how many litres of paint is required to paint the internal and external surface areas of a cylindrical tunnel whose thickness is 2 m, internal radius is 6 m and height is 25 m.

**Solution** Given that, height  $h = 25 \text{ m}$ ; thickness = 2 m

$$\text{internal radius } r = 6 \text{ m}$$

$$\text{Now, external radius } R = 6 + 2 = 8 \text{ m}$$

$$\text{C.S.A. of the cylindrical tunnel} = \text{C.S.A. of the hollow cylinder} \quad \text{Fig. 7.8}$$

$$\begin{aligned}\text{C.S.A. of the hollow cylinder} &= 2\pi(R + r)h \text{ sq. units} \\ &= 2 \times \frac{22}{7} (8 + 6) \times 25\end{aligned}$$

$$\text{Hence, C.S.A. of the cylindrical tunnel} = 2200 \text{ m}^2$$

$$\text{Area covered by one litre of paint} = 10 \text{ m}^2$$

$$\text{Number of litres required to paint the tunnel} = \frac{2200}{10} = 220$$

Therefore, 220 litres of paint is needed to paint the tunnel.

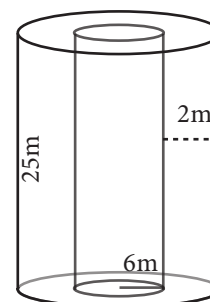

### Progress Check

1. Right circular cylinder is a solid obtained by revolving \_\_\_\_\_ about \_\_\_\_\_.
2. In a right circular cylinder the axis is \_\_\_\_\_ to the diameter.
3. The difference between the C.S.A. and T.S.A. of a right circular cylinder is \_\_\_\_\_.
4. The C.S.A. of a right circular cylinder of equal radius and height is \_\_\_\_\_ the area of its base.

### 7.2.3 Right Circular Cone

Observe the given figures in Fig.7.9 and identify which solid shape they represent?

These objects resemble the shape of a cone.



Fig. 7.9

**Definition :** A right circular cone is a solid generated by the revolution of a right angled triangle about one of the sides containing the right angle as axis.

**Formation of a Right Circular Cone - Demonstration**

In Fig. 7.10, if the right triangle  $ABC$  revolves about  $AB$  as axis, the hypotenuse  $AC$  generates the curved surface of the cone represented in the diagram. The height of the cone is the length of the axis  $AB$ , and the slant height is the length of the hypotenuse  $AC$ .

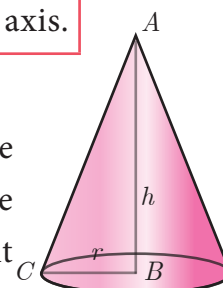

Fig. 7.10

**Surface area of a right circular cone**

Suppose the surface area of the cone is cut along the hypotenuse  $AC$  and then unrolled on a plane, the surface area will take the form of a sector  $ACD$ , of which the radius  $AC$  and the arc  $CD$  are respectively the slant height and the circumference of the base of the cone.

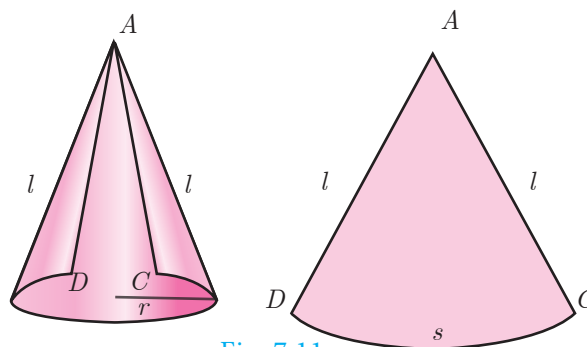

Fig. 7.11

Here the sector of radius ' $l$ ' and arc length ' $s$ ' will be similar to a circle of radius  $l$ .

**(i) Curved surface area**

$$\frac{\text{Area of the sector}}{\text{Area of the circle}} = \frac{\text{Arc length of the sector}}{\text{Circumference of the circle}}$$

$$\text{Area of the sector} = \frac{\text{Arc length of the sector}}{\text{Circumference of the circle}} \times \text{Area of the circle}$$

$$= \frac{s}{2\pi l} \times \pi l^2 = \frac{s}{2} \times l = \frac{2\pi r}{2} \times l \quad (\because s = 2\pi r)$$

$\therefore$  Curved Surface Area of the cone = Area of the Sector =  $\pi rl$  sq. units.

**C.S.A. of a right circular cone =  $\pi rl$  sq. units.**

**Thinking Corner**



1. Give practical example of solid cone.
2. Find surface area of a cone in terms of its radius when height is equal to radius.
3. Compare the above surface area with the area of the base of the cone.



**Activity 1**

- (i) Take a semi-circular paper with radius 7 cm and make it a cone. Find the C.S.A. of the cone.
- (ii) Take a quarter circular paper with radius 3.5 cm and make it a cone. Find the C.S.A. of the cone.





### Derivation of slant height ' $l$ '

$ABC$  is a right angled triangle, right angled at  $B$ . The hypotenuse, base and height of the triangle are represented by  $l$ ,  $r$  and  $h$  respectively.

Now, using Pythagoras theorem in  $\triangle ABC$ ,

$$AC^2 = AB^2 + BC^2$$

$$l^2 = h^2 + r^2$$

$$l = \sqrt{h^2 + r^2} \text{ units}$$

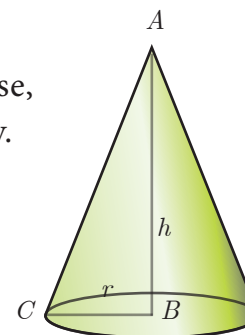

Fig. 7.12

### (ii) Total surface area

$$\begin{aligned} \text{Total surface area of a cone} &= \text{C.S.A.} + \text{base area of the cone} \\ &= \pi r l + \pi r^2 \quad (\because \text{the base is a circle}) \end{aligned}$$

$$\text{T.S.A. of a right circular cone} = \pi r(l + r) \text{ sq. units.}$$

**Example 7.5** The radius of a conical tent is 7 m and the height is 24 m. Calculate the length of the canvas used to make the tent if the width of the rectangular canvas is 4 m?

**Solution** Let  $r$  and  $h$  be the radius and height of the cone respectively.

Given that, radius  $r = 7$  m and height  $h = 24$  m

$$\text{Hence, } l = \sqrt{r^2 + h^2}$$

$$= \sqrt{49 + 576}$$

$$l = \sqrt{625} = 25 \text{ m}$$

$$\text{C.S.A. of the conical tent} = \pi r l \text{ sq. units}$$

$$\text{Area of the canvas} = \frac{22}{7} \times 7 \times 25 = 550 \text{ m}^2$$

$$\text{Now, length of the canvas} = \frac{\text{Area of the canvas}}{\text{width}} = \frac{550}{4} = 137.5 \text{ m}$$

Therefore, the length of the canvas is 137.5 m

**Example 7.6** If the total surface area of a cone of radius 7 cm is  $704 \text{ cm}^2$ , then find its slant height.

**Solution** Given that, radius  $r = 7$  cm

$$\text{Now, total surface area of the cone} = \pi r(l + r) \text{ sq. units}$$

$$\text{T.S.A.} = 704 \text{ cm}^2$$

$$704 = \frac{22}{7} \times 7(l + 7)$$

$$32 = l + 7 \Rightarrow l = 25 \text{ cm}$$

Therefore, slant height of the cone is 25 cm.



**Example 7.7** From a solid cylinder whose height is 2.4 cm and diameter 1.4 cm, a conical cavity of the same height and base is hollowed out (Fig.7.13). Find the total surface area of the remaining solid.

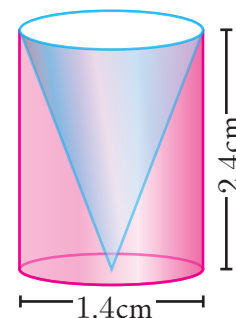

Fig. 7.13

**Solution** Let  $h$  and  $r$  be the height and radius of the cone and cylinder.

Let  $l$  be the slant height of the cone.

Given that,  $h = 2.4$  cm and  $d = 1.4$  cm ;  $r = 0.7$  cm

$$\begin{aligned} \left. \begin{array}{l} \text{Total surface area of the} \\ \text{remaining solid} \end{array} \right\} &= \text{C.S.A. of the cylinder} + \text{C.S.A. of the cone} \\ &\quad + \text{area of the bottom} \\ &= 2\pi rh + \pi rl + \pi r^2 \text{ sq. units} \\ &= \pi r(2h + l + r) \text{ sq. units} \end{aligned}$$

Now,  $l = \sqrt{r^2 + h^2} = \sqrt{0.49 + 5.76} = \sqrt{6.25} = 2.5$  cm

$l = 2.5$  cm

$$\begin{aligned} \text{Area of the remaining solid} &= \pi r(2h + l + r) \text{ sq. units} \\ &= \frac{22}{7} \times 0.7 \times [(2 \times 2.4) + 2.5 + 0.7] \\ &= 17.6 \end{aligned}$$

Therefore, total surface area of the remaining solid is 17.6 cm<sup>2</sup>



### Progress Check

1. Right circular cone is a solid obtained by revolving \_\_\_\_ about \_\_\_\_.
2. In a right circular cone the axis is \_\_\_\_ to the diameter.
3. The difference between the C.S.A. and T.S.A. of a cone is \_\_\_\_.
4. When a sector of a circle is transformed to form a cone, then match the conversions taking place between the sector and the cone.

Sector	Cone
Radius	Circumference of the base
Area	Slant height
Arc length	Curved surface area

### 7.2.4 The Sphere

**Definition :** A sphere is a solid generated by the revolution of a semicircle about its diameter as axis.



Every plane section of a sphere is a circle. The line of section of a sphere by a plane passing through the centre of the sphere is called a great circle all other plane sections are called small circles.

As shown in the diagram, circle with  $CD$  as diameter is a great circle, whereas, the circle with  $QR$  as diameter is a small circle.

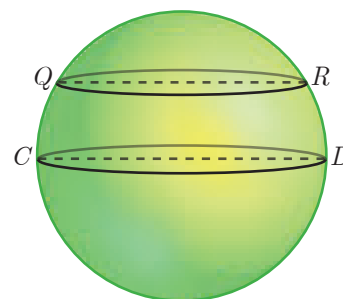

Fig. 7.14

### Surface area of a sphere

#### Archimedes Proof

Place a sphere inside a right circular cylinder of equal diameter and height. Then the height of the cylinder will be the diameter of the sphere. In this case, Archimedes proved that the outer area of the sphere is same as curved surface area of the cylinder.

$$\begin{aligned} \text{Surface area of sphere} &= \text{curved surface area of cylinder} \\ &= 2\pi rh = 2\pi r(2r) \end{aligned}$$

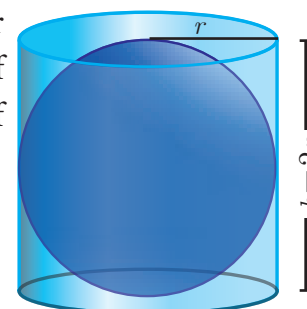

Fig. 7.15

**Surface area of a sphere =  $4\pi r^2$  sq.units**



#### Activity 2

- (i) Take a sphere of radius 'r'.
- (ii) Take a cylinder whose base diameter and height are equal to the diameter of the sphere.
- (iii) Now, roll thread around the surface of the sphere and the cylinder without overlapping and leaving space between the threads.
- (iv) Now compare the length of the two threads in both the cases.
- (v) Use this information to find surface area of sphere.

### 7.2.5 Hemisphere

A section of the sphere cut by a plane through any of its great circle is a hemisphere.

By doing this, we observe that a hemisphere is exactly half the portion of the sphere.

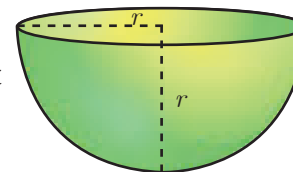

Fig. 7.16

$$\text{Curved surface area of hemisphere} = \frac{\text{C.S.A. of the sphere}}{2} = \frac{4\pi r^2}{2}$$

**C.S.A. of a hemisphere =  $2\pi r^2$  sq.units**

$$\begin{aligned} \text{Total surface area of hemisphere} &= \text{C.S.A.} + \text{Area of top circular region} \\ &= 2\pi r^2 + \pi r^2 \end{aligned}$$

**T.S.A. of a hemisphere =  $3\pi r^2$  sq.units**

### 7.2.6 Hollow Hemisphere

Let the inner radius be  $r$  and outer radius be  $R$ ,  
then thickness =  $R - r$

Therefore,

$$\begin{aligned}\text{C.S.A.} &= \text{Area of external hemisphere} \\ &+ \text{Area of internal hemisphere} \\ &= 2\pi R^2 + 2\pi r^2\end{aligned}$$

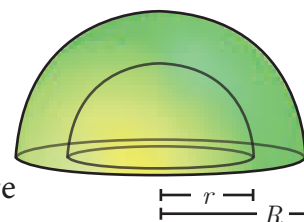

Fig. 7.17

$$\text{C.S.A. of a hollow hemisphere} = 2\pi(R^2 + r^2) \text{ sq. units}$$

$$\begin{aligned}\text{T.S.A.} &= \text{C.S.A.} + \text{Area of annulus region} \\ &= 2\pi(R^2 + r^2) + \pi(R^2 - r^2) \\ &= \pi[2R^2 + 2r^2 + R^2 - r^2]\end{aligned}$$

$$\text{T.S.A. of a hollow hemisphere} = \pi(3R^2 + r^2) \text{ sq. units}$$

**Example 7.8** Find the diameter of a sphere whose surface area is  $154 \text{ m}^2$ .

**Solution** Let  $r$  be the radius of the sphere.

Given that, surface area of sphere =  $154 \text{ m}^2$

$$\begin{aligned}4\pi r^2 &= 154 \\ 4 \times \frac{22}{7} \times r^2 &= 154 \\ \Rightarrow r^2 &= 154 \times \frac{1}{4} \times \frac{7}{22} \\ r^2 &= \frac{49}{4} \text{ we get } r = \frac{7}{2}\end{aligned}$$

Therefore, diameter is 7 m

#### Activity 3

Using a globe, list any two countries in the northern and southern hemispheres.

→ Northern Hemisphere

→ Equator

→ Southern Hemisphere

Fig. 7.18

**Example 7.9** The radius of a spherical balloon increases from 12 cm to 16 cm as air being pumped into it. Find the ratio of the surface area of the balloons in the two cases.

**Solution** Let  $r_1$  and  $r_2$  be the radii of the balloons.

$$\text{Given that, } \frac{r_1}{r_2} = \frac{12}{16} = \frac{3}{4}$$

$$\text{Now, ratio of C.S.A. of balloons} = \frac{4\pi r_1^2}{4\pi r_2^2} = \frac{r_1^2}{r_2^2} = \left(\frac{r_1}{r_2}\right)^2 = \left(\frac{3}{4}\right)^2 = \frac{9}{16}$$

Therefore, ratio of C.S.A. of balloons is 9:16.

#### Thinking Corner

1. Find the value of the radius of a sphere whose surface area is  $36\pi$  sq. units.
2. How many great circles can a sphere have?
3. Find the surface area of the earth whose diameter is 12756 kms.



**Progress Check**

1. Every section of a sphere by a plane is a \_\_\_\_\_.
2. The centre of a great circle is at the \_\_\_\_\_ of the sphere.
3. The difference between the T.S.A. and C.S.A. of hemisphere is \_\_\_\_\_.
4. The ratio of surface area of a sphere and C.S.A. of hemisphere is \_\_\_\_\_.
5. A section of the sphere by a plane through any of its great circle is \_\_\_\_\_.

**Example 7.10** If the base area of a hemispherical solid is 1386 sq. metres, then find its total surface area?

**Solution** Let  $r$  be the radius of the hemisphere.

Given that, base area =  $\pi r^2 = 1386$  sq. m

$$\begin{aligned} \text{T.S.A.} &= 3\pi r^2 \text{ sq.m} \\ &= 3 \times 1386 = 4158 \end{aligned}$$

Therefore, T.S.A. of the hemispherical solid is  $4158 \text{ m}^2$ .

**Note**

For finding the C.S.A. and T.S.A. of a hollow sphere, the formula for finding the surface area of a sphere can be used.

**Thinking Corner**

1. Shall we get a hemisphere when a sphere is cut along the small circle?
2. T.S.A of a hemisphere is equal to how many times the area of its base?
3. How many hemispheres can be obtained from a given sphere?

**Example 7.11** The internal and external radii of a hollow hemispherical shell are 3 m and 5 m respectively. Find the T.S.A. and C.S.A. of the shell.

**Solution** Let the internal and external radii of the hemispherical shell be  $r$  and  $R$  respectively.

Given that,  $R = 5 \text{ m}$ ,  $r = 3 \text{ m}$

$$\begin{aligned} \text{C.S.A. of the shell} &= 2\pi(R^2 + r^2) \text{ sq. units} \\ &= 2 \times \frac{22}{7} \times (25 + 9) = 213.71 \end{aligned}$$

$$\begin{aligned} \text{T.S.A. of the shell} &= \pi(3R^2 + r^2) \text{ sq. units} \\ &= \frac{22}{7}(75 + 9) = 264 \end{aligned}$$

Therefore, C.S.A. =  $213.71 \text{ m}^2$  and T.S.A. =  $264 \text{ m}^2$ .

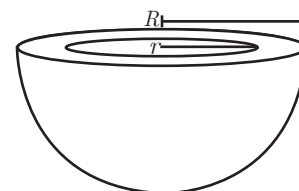

Fig. 7.19

**Example 7.12** A sphere, a cylinder and a cone are of the same height which is equal to its radius, where as cone and cylinder are of same height. Find the ratio of their curved surface areas.

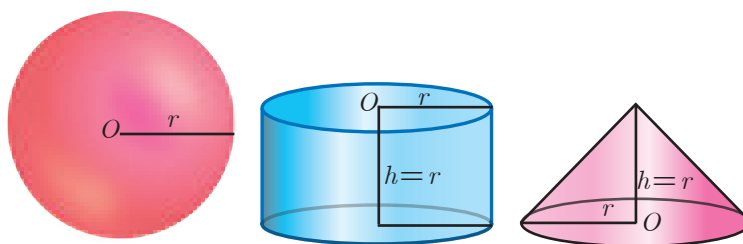

Fig. 7.20

**Solution** Required Ratio = C.S.A. of the sphere: C.S.A. of the cylinder : C.S.A. of the cone

$$\begin{aligned}
 &= 4\pi r^2 : 2\pi rh : \pi rl && (l = \sqrt{r^2 + h^2} = \sqrt{2r^2} = \sqrt{2}r) \\
 &= 4\pi r^2 : 2\pi r^2 : \pi r\sqrt{2}r \\
 &= 4\pi r^2 : 2\pi r^2 : \sqrt{2}\pi r^2 \\
 &= 4 : 2 : \sqrt{2} = 2\sqrt{2} : \sqrt{2} : 1
 \end{aligned}$$

### 7.2.7 Frustum of a right circular cone

In olden days a cone shaped buckets [Fig.7.21(a)] filled with sand / water were used to extinguish fire during fire accidents. Later, it was reshaped to a round shaped bottom [Fig.7.21(b)] to increase its volume.



Fig. 7.21(a)      Fig. 7.21(b)      Fig. 7.21(c)

The shape in [Fig.7.21(c)] resembling an inverted bucket is called as a frustum of a cone.

The objects which we use in our daily life such as glass, bucket, street cone are examples of frustum of a cone. (Fig.7.22)



Fig. 7.22

**Definition**

When a cone ABC is cut through by a plane parallel to its base, the portion of the cone DECB between the cutting plane and the base is called a frustum of the cone.

Fig. 7.23

### Surface area of a frustum

Let  $R$  and  $r$  be radii of the base and top region of the frustum  $DECB$  respectively,  $h$  is the height and  $l$  is the slant height of the same.

$$\begin{aligned}
 \text{Therefore, C.S.A.} &= \frac{1}{2} (\text{sum of the perimeters of base and top region}) \times \text{slant height} \\
 &= \frac{1}{2} (2\pi R + 2\pi r)l
 \end{aligned}$$

**C.S.A. of a frustum =  $\pi(R + r)l$  sq. units**

where,  $l = \sqrt{h^2 + (R - r)^2}$

T.S.A. = C.S.A. + Area of the bottom circular region  
+ Area of the top circular region.

**T.S.A. of a frustum =  $\pi(R + r)l + \pi R^2 + \pi r^2$  sq. units**

where,  $l = \sqrt{h^2 + (R - r)^2}$

**Example 7.13** The slant height of a frustum of a cone is 5 cm and the radii of its ends are 4 cm and 1 cm. Find its curved surface area.

**Solution** Let  $l$ ,  $R$  and  $r$  be the slant height, top radius and bottom radius of the frustum.

Given that,  $l = 5$  cm,  $R = 4$  cm,  $r = 1$  cm

Now, C.S.A. of the frustum  $= \pi(R + r)l$  sq. units

$$= \frac{22}{7} \times (4 + 1) \times 5$$

$$= \frac{550}{7}$$

Therefore, C.S.A.  $= 78.57$  cm<sup>2</sup>

### Thinking Corner



1. Give two real life examples for a frustum of a cone.
2. Can a hemisphere be considered as a frustum of a sphere.

**Example 7.14** An industrial metallic bucket is in the shape of the frustum of a right circular cone whose top and bottom diameters are 10 m and 4 m and whose height is 4 m. Find the curved and total surface area of the bucket.

**Solution** Let  $h$ ,  $l$ ,  $R$  and  $r$  be the height, slant height, top radius and bottom radius of the frustum.

Given that, diameter of the top = 10 m; radius of the top  $R = 5$  m.

diameter of the bottom = 4 m; radius of the bottom  $r = 2$  m, height  $h = 4$  m

$$\text{Now, } l = \sqrt{h^2 + (R - r)^2}$$

$$= \sqrt{4^2 + (5 - 2)^2}$$

$$l = \sqrt{16 + 9} = \sqrt{25} = 5 \text{ m}$$

C.S.A.  $= \pi(R + r)l$  sq. units

$$= \frac{22}{7} (5 + 2) \times 5 = 110 \text{ m}^2$$

T.S.A.  $= \pi(R + r)l + \pi R^2 + \pi r^2$  sq. units

$$= \frac{22}{7} [(5 + 2)5 + 25 + 4] = \frac{1408}{7} = 201.14$$

Therefore, C.S.A.  $= 110$  m<sup>2</sup> and T.S.A.  $= 201.14$  m<sup>2</sup>

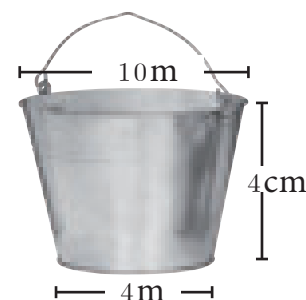

Fig. 7.24



### Progress Check

1. The portion of a right circular cone intersected between two parallel planes is \_\_\_\_\_.
2. How many frustums can a right circular cone have?



### Exercise 7.1

- The radius and height of a cylinder are in the ratio 5:7 and its curved surface area is 5500 sq.cm. Find its radius and height.
- A solid iron cylinder has total surface area of 1848 sq.m. Its curved surface area is five – sixth of its total surface area. Find the radius and height of the iron cylinder.
- The external radius and the length of a hollow wooden log are 16 cm and 13 cm respectively. If its thickness is 4 cm then find its T.S.A.
- A right angled triangle  $PQR$  where  $\angle Q = 90^\circ$  is rotated about  $QR$  and  $PQ$ . If  $QR = 16$  cm and  $PR = 20$  cm, compare the curved surface areas of the right circular cones so formed by the triangle.
- 4 persons live in a conical tent whose slant height is 19 m. If each person require  $22 \text{ m}^2$  of the floor area, then find the height of the tent.
- A girl wishes to prepare birthday caps in the form of right circular cones for her birthday party, using a sheet of paper whose area is  $5720 \text{ cm}^2$ , how many caps can be made with radius 5 cm and height 12 cm.
- The ratio of the radii of two right circular cones of same height is 1:3. Find the ratio of their curved surface area when the height of each cone is 3 times the radius of the smaller cone.
- The radius of a sphere increases by 25%. Find the percentage increase in its surface area.
- The internal and external diameters of a hollow hemispherical vessel are 20 cm and 28 cm respectively. Find the cost to paint the vessel all over at ₹ 0.14 per  $\text{cm}^2$ .
- The frustum shaped outer portion of the table lamp has to be painted including the top part. Find the total cost of painting the lamp if the cost of painting 1 sq.cm is ₹ 2.

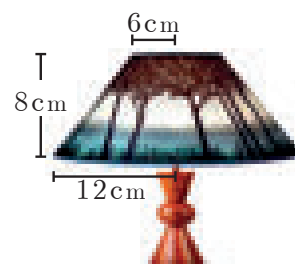

## 7.3 Volume

Having discussed about the surface areas of cylinder, cone, sphere, hemisphere and frustum, we shall now discuss about the volumes of these solids.

Volume refers to the amount of space occupied by an object. The volume is measured in cubic units.

### 7.3.1 Volume of a solid right circular cylinder

The volume of a right circular cylinder of base radius ' $r$ ' and height ' $h$ ' is given by  $V = (\text{Base Area}) \times (\text{Height}) = \pi r^2 \times h = \pi r^2 h$  cubic units.

Therefore, **Volume of a cylinder =  $\pi r^2 h$  cu. units.**

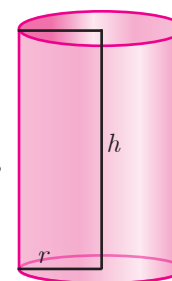

Fig. 7.25



### 7.3.2 Volume of a hollow cylinder (volume of the material used)

Let the internal and external radii of a hollow cylinder be  $r$  and  $R$  units respectively. If the height of the cylinder is  $h$  units then

$$\begin{aligned} \text{The volume } V &= \left\{ \begin{array}{l} \text{volume of the} \\ \text{outer cylinder} \end{array} \right\} - \left\{ \begin{array}{l} \text{volume of the} \\ \text{inner cylinder} \end{array} \right\} \\ V &= \pi R^2 h - \pi r^2 h = \pi(R^2 - r^2)h \end{aligned}$$

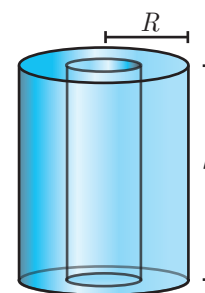

Fig. 7.26

$$\text{Volume of a hollow cylinder} = \pi(R^2 - r^2)h \text{ cu. units.}$$

**Example 7.15** Find the volume of a cylinder whose height is 2 m and whose base area is  $250 \text{ m}^2$ .

**Solution** Let  $r$  and  $h$  be the radius and height of the cylinder respectively.

$$\text{Given that, height } h = 2 \text{ m, base area} = 250 \text{ m}^2$$

$$\begin{aligned} \text{Now, volume of a cylinder} &= \pi r^2 h \text{ cu. units} \\ &= \text{base area} \times h \\ &= 250 \times 2 = 500 \text{ m}^3 \end{aligned}$$

$$\text{Therefore, volume of the cylinder} = 500 \text{ m}^3$$

#### Thinking Corner

1. If the height is inversely proportional to the square of its radius, the volume of the cylinder is \_\_\_\_\_.
2. What happens to the volume of the cylinder with radius  $r$  and height  $h$ , when its (a) radius is halved (b) height is halved.

**Example 7.16** The volume of a cylindrical water tank is  $1.078 \times 10^6$  litres. If the diameter of the tank is 7 m, find its height.

**Solution** Let  $r$  and  $h$  be the radius and height of the cylinder respectively.

$$\begin{aligned} \text{Given that, volume of the tank} &= 1.078 \times 10^6 = 1078000 \text{ litre} \\ &= 1078 \text{ m}^3 \quad (\because 1 \text{ l} = \frac{1}{1000} \text{ m}^3) \end{aligned}$$

$$\text{diameter} = 7 \text{ m} \Rightarrow \text{radius} = \frac{7}{2} \text{ m}$$

$$\text{volume of the tank} = \pi r^2 h \text{ cu. units}$$

$$1078 = \frac{22}{7} \times \frac{7}{2} \times \frac{7}{2} \times h$$

Therefore, height of the tank is 28 m

**Example 7.17** Find the volume of the iron used to make a hollow cylinder of height 9 cm and whose internal and external radii are 21 cm and 28 cm respectively.

**Solution** Let  $r$ ,  $R$  and  $h$  be the internal radius, external radius and height of the hollow cylinder respectively.

Given that,  $r = 21\text{cm}$ ,  $R = 28\text{ cm}$ ,  $h = 9\text{ cm}$

$$\begin{aligned}\text{Now, volume of hollow cylinder} &= \pi(R^2 - r^2)h \text{ cu. units} \\ &= \frac{22}{7}(28^2 - 21^2) \times 9 \\ &= \frac{22}{7}(784 - 441) \times 9 = 9702\end{aligned}$$

Therefore, volume of iron used = 9702 cm<sup>3</sup>

**Example 7.18** For the cylinders  $A$  and  $B$  (Fig. 7.27),

- find out the cylinder whose volume is greater.
- verify whether the cylinder with greater volume has greater total surface area.
- find the ratios of the volumes of the cylinders  $A$  and  $B$ .

**Solution**

(i) Volume of cylinder =  $\pi r^2 h$  cu. units

$$\begin{aligned}\text{Volume of cylinder } A &= \frac{22}{7} \times \frac{7}{2} \times \frac{7}{2} \times 21 \\ &= 808.5 \text{ cm}^3\end{aligned}$$

$$\begin{aligned}\text{Volume of cylinder } B &= \frac{22}{7} \times \frac{21}{2} \times \frac{21}{2} \times 7 \\ &= 2425.5 \text{ cm}^3\end{aligned}$$

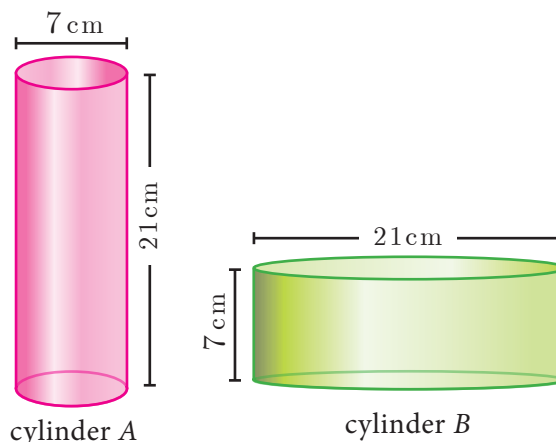

Fig. 7.27

Therefore, volume of cylinder  $B$  is greater than volume of cylinder  $A$ .

(ii) T.S.A. of cylinder =  $2\pi r(h + r)$  sq. units

$$\text{T.S.A. of cylinder } A = 2 \times \frac{22}{7} \times \frac{7}{2} \times (21 + 3.5) = 539 \text{ cm}^2$$

$$\text{T.S.A. of cylinder } B = 2 \times \frac{22}{7} \times \frac{21}{2} \times (7 + 10.5) = 1155 \text{ cm}^2$$

Hence verified that cylinder  $B$  with greater volume has a greater surface area.

$$(iii) \frac{\text{Volume of cylinder } A}{\text{Volume of cylinder } B} = \frac{808.5}{2425.5} = \frac{1}{3}$$

Therefore, ratio of the volumes of cylinders  $A$  and  $B$  is 1:3.

### 7.3.3 Volume of a right circular cone

Let  $r$  and  $h$  be the radius and height of a cone then its volume

$$V = \frac{1}{3}\pi r^2 h \text{ cu. units.}$$

#### Demonstration

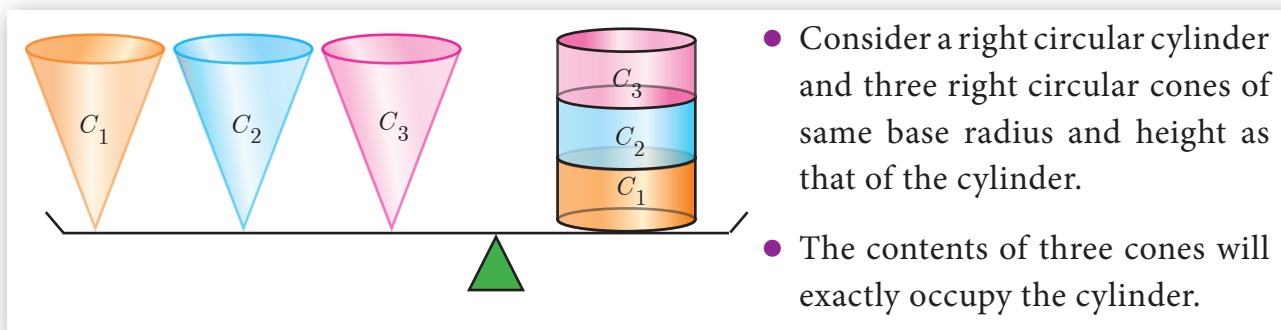

Fig. 7.28

From, Fig.7.28 we see that,

$$\begin{aligned} 3 \times (\text{Volume of a cone}) &= \text{Volume of cylinder} \\ &= \pi r^2 h \text{ cu. units} \end{aligned}$$

$$\text{Volume of a cone} = \frac{1}{3}\pi r^2 h \text{ cu. units}$$

**Example 7.19** The volume of a solid right circular cone is  $11088 \text{ cm}^3$ . If its height is  $24 \text{ cm}$  then find the radius of the cone.

**Solution** Let  $r$  and  $h$  be the radius and height of the cone respectively.

$$\text{Given that, volume of the cone} = 11088 \text{ cm}^3$$

$$\frac{1}{3}\pi r^2 h = 11088$$

$$\frac{1}{3} \times \frac{22}{7} \times r^2 \times 24 = 11088$$

$$r^2 = 441$$

$$\text{Therefore, radius of the cone } r = 21 \text{ cm}$$

#### Thinking Corner

- Is it possible to find a right circular cone with equal
  - height and slant height
  - radius and slant height
  - height and radius.
- There are two cones with equal volumes. What will be the ratio of their radius and height?



**Example 7.20** The ratio of the volumes of two cones is 2:3. Find the ratio of their radii if the height of second cone is double the height of the first.

**Solution** Let  $r_1$  and  $h_1$  be the radius and height of the cone-I and let  $r_2$  and  $h_2$  be the radius and height of the cone-II.

Given that,  $h_2 = 2h_1$  and  $\frac{\text{Volume of the cone I}}{\text{Volume of the cone II}} = \frac{2}{3}$

$$\frac{\frac{1}{3} \pi r_1^2 h_1}{\frac{1}{3} \pi r_2^2 h_2} = \frac{2}{3} \Rightarrow \frac{r_1^2 \times h_1}{r_2^2 \times 2h_1} = \frac{2}{3}$$

$$\frac{r_1^2}{r_2^2} = \frac{4}{3} \Rightarrow \frac{r_1}{r_2} = \frac{2}{\sqrt{3}}$$

Therefore, ratio of their radii =  $2 : \sqrt{3}$



### Progress Check

- Volume of a cone is the product of its base area and \_\_\_\_\_.
- If the radius of the cone is doubled, the new volume will be \_\_\_\_\_ times the original volume.
- Consider the cones given in Fig.7.29
  - Without doing any calculation, find out whose volume is greater?
  - Verify whether the cone with greater volume has greater surface area.
  - Volume of cone A : Volume of cone B = ?

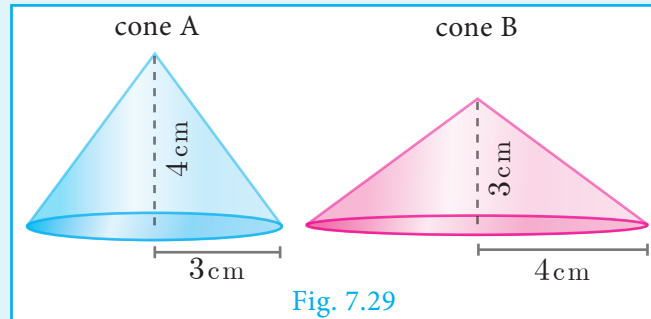

### 7.3.4 Volume of sphere

Let  $r$  be the radius of a sphere then its volume is given by  $V = \frac{4}{3} \pi r^3$  cu. units.

#### Demonstration

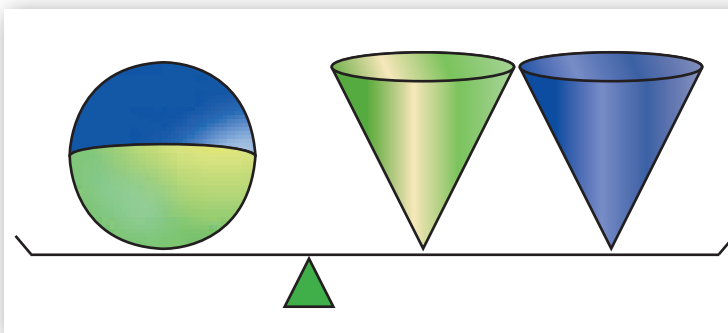

- Consider a sphere and two right circular cones of same base radius and height such that twice the radius of the sphere is equal to the height of the cones.
- Then we can observe that the contents of two cones will exactly occupy the sphere.

Fig. 7.30

From the Fig.7.30, we see that

$$\text{Volume of a sphere} = 2 \times (\text{Volume of a cone})$$

where the diameters of sphere and cone are equal to the height of the cone.

$$= 2 \left( \frac{1}{3} \pi r^2 h \right)$$

$$= \frac{2}{3} \pi r^2 (2r), \quad (\because h = 2r)$$

$$\text{Volume of a sphere} = \frac{4}{3} \pi r^3 \text{ cu. units}$$

### 7.3.5 Volume of a hollow sphere / spherical shell (volume of the material used)

Let  $r$  and  $R$  be the inner and outer radius of the hollow sphere.

Volume enclosed between the outer and inner spheres

$$= \frac{4}{3} \pi R^3 - \frac{4}{3} \pi r^3$$

$$\text{Volume of a hollow sphere} = \frac{4}{3} \pi (R^3 - r^3) \text{ cu. units}$$

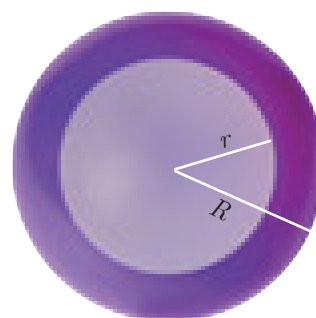

Fig. 7.31

### 7.3.6 Volume of solid hemisphere

Let  $r$  be the radius of the solid hemisphere.

Volume of the solid hemisphere =  $\frac{1}{2}$  (volume of sphere)

$$= \frac{1}{2} \left[ \frac{4}{3} \pi r^3 \right]$$

$$\text{Volume of a solid hemisphere} = \frac{2}{3} \pi r^3 \text{ cu. units}$$

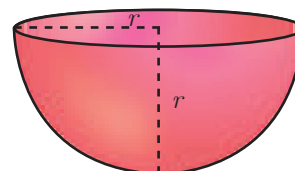

Fig. 7.32

### 7.3.7 Volume of hollow hemisphere (volume of the material used)

Let  $r$  and  $R$  be the inner and outer radius of the hollow hemisphere.

$$\left. \begin{array}{l} \text{Volume of hollow} \\ \text{hemisphere} \end{array} \right\} = \left[ \begin{array}{l} \text{Volume of outer} \\ \text{hemisphere} \end{array} \right] - \left[ \begin{array}{l} \text{Volume of inner} \\ \text{hemisphere} \end{array} \right]$$

$$= \frac{2}{3} \pi R^3 - \frac{2}{3} \pi r^3$$

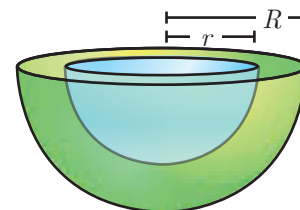

Fig. 7.33

$$\text{Volume of a hollow hemisphere} = \frac{2}{3} \pi (R^3 - r^3) \text{ cu. units}$$

### Thinking Corner

A cone, a hemisphere and a cylinder have equal bases. The heights of the cone and cylinder are equal and are same as the common radius. Are they equal in volume?



**Example 7.21** The volume of a solid hemisphere is  $29106 \text{ cm}^3$ . Another hemisphere whose volume is two-third of the above is carved out. Find the radius of the new hemisphere.

**Solution** Let  $r$  be the radius of the hemisphere.

Given that, volume of the hemisphere =  $29106 \text{ cm}^3$

$$\begin{aligned}\text{Now, volume of new hemisphere} &= \frac{2}{3} (\text{Volume of original sphere}) \\ &= \frac{2}{3} \times 29106\end{aligned}$$

Volume of new hemisphere =  $19404 \text{ cm}^3$

$$\begin{aligned}\frac{2}{3} \pi r^3 &= 19404 \\ r^3 &= \frac{19404 \times 3 \times 7}{2 \times 22} = 9261\end{aligned}$$

$$r = \sqrt[3]{9261} = 21 \text{ cm}$$

Therefore,  $r = 21 \text{ cm}$

### Thinking Corner

1. Give any two real life examples of sphere and hemisphere.
2. A plane along a great circle will split the sphere into \_\_\_\_\_ parts.
3. If the volume and surface area of a sphere are numerically equal, then the radius of the sphere is \_\_\_\_\_.

**Example 7.22** Calculate the mass of a hollow brass sphere if the inner diameter is 14 cm and thickness is 1mm, and whose density is  $17.3 \text{ g/ cm}^3$ . (**Hint:**  $\text{mass} = \text{density} \times \text{volume}$ )

**Solution** Let  $r$  and  $R$  be the inner and outer radii of the hollow sphere.

Given that, inner diameter  $d = 14 \text{ cm}$ ; inner radius  $r = 7 \text{ cm}$ ; thickness =  $1 \text{ mm} = \frac{1}{10} \text{ cm}$

$$\text{Outer radius } R = 7 + \frac{1}{10} = \frac{71}{10} = 7.1 \text{ cm}$$

$$\begin{aligned}\text{Volume of hollow sphere} &= \frac{4}{3} \pi (R^3 - r^3) \text{ cu. units} \\ &= \frac{4}{3} \times \frac{22}{7} (357.91 - 343) = 62.48 \text{ cm}^3\end{aligned}$$

But, density of brass in  $1 \text{ cm}^3 = 17.3 \text{ gm}$

$$\text{Total mass} = 17.3 \times 62.48 = 1080.90 \text{ gm}$$

Therefore, total mass is 1080.90 grams.



**Progress Check**

1. What is the ratio of volume to surface area of a sphere?
2. The relationship between the height and radius of the hemisphere is \_\_\_\_\_.
3. The volume of a sphere is the product of its surface area and \_\_\_\_\_.

**7.3.8 Volume of frustum of a cone**

Let  $H$  and  $h$  be the height of cone and frustum respectively,  $L$  and  $l$  be the slant height of the same.

If  $R, r$  are the radii of the circular bases of the frustum, then volume of the frustum of the cone is the difference of the volumes of the two cones.

$$V = \frac{1}{3} \pi R^2 H - \frac{1}{3} \pi r^2 (H - h)$$

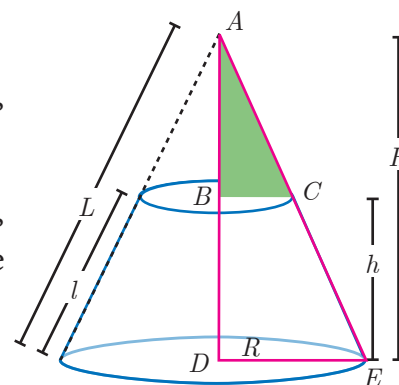

Fig. 7.34

Since the triangles  $ABC$  and  $ADE$  are similar, the ratio of their corresponding sides are proportional.

Therefore,  $\frac{H-h}{H} = \frac{r}{R} \Rightarrow H = \frac{hR}{R-r}$  ... (1)

$$\begin{aligned} V &= \frac{1}{3} \pi R^2 H - \frac{1}{3} \pi r^2 (H - h) \\ &= \frac{\pi}{3} H (R^2 - r^2) + \frac{1}{3} \pi r^2 h \\ &= \frac{\pi}{3} \frac{hR}{R-r} (R^2 - r^2) + \frac{\pi}{3} r^2 h \text{ [using (1)]} \\ &= \frac{\pi}{3} hR(R+r) + \frac{\pi}{3} r^2 h \end{aligned}$$



**Thinking Corner**

Is it possible to obtain the volume of the full cone when the volume of the frustum is known?

**Volume of a frustum =  $\frac{\pi h}{3} (R^2 + Rr + r^2)$  cu. units**

**Example 7.23** If the radii of the circular ends of a frustum which is 45 cm high are 28 cm and 7 cm, find the volume of the frustum.

**Solution** Let  $h, r$  and  $R$  be the height, top and bottom radii of the frustum.

Given that,  $h = 45$  cm,  $R = 28$  cm,  $r = 7$  cm

$$\begin{aligned} \text{Volume} &= \frac{1}{3} \pi [R^2 + Rr + r^2] h \text{ cu. units} \\ &= \frac{1}{3} \times \frac{22}{7} \times [28^2 + (28 \times 7) + 7^2] \times 45 \\ &= \frac{1}{3} \times \frac{22}{7} \times 1029 \times 45 = 48510 \end{aligned}$$

Therefore, volume of the frustum is 48510 cm<sup>3</sup>

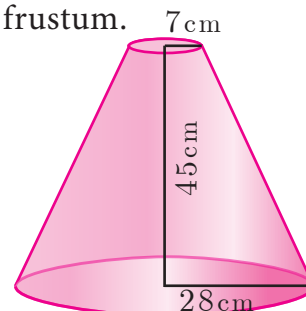

Fig. 7.35



The adjacent figure represents an oblique frustum of a cylinder. Suppose this solid is cut by a plane through  $C$ , not parallel to the base  $AB$ , then

$$CSA = 2\pi r \times \frac{h_1 + h_2}{2} \text{ sq. units}$$

where  $h_1$  and  $h_2$  denote the greatest and least height of the frustum.

$$\text{Then its volume} = \pi r^2 \times \frac{h_1 + h_2}{2} \text{ cu. units}$$

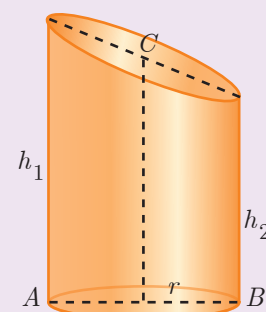

Fig. 7.36



### Exercise 7.2

1. A 14 m deep well with inner diameter 10 m is dug and the earth taken out is evenly spread all around the well to form an embankment of width 5 m. Find the height of the embankment.
2. A cylindrical glass with diameter 20 cm has water to a height of 9 cm. A small cylindrical metal of radius 5 cm and height 4 cm is immersed completely. Calculate the raise of the water in the glass?
3. If the circumference of a conical wooden piece is 484 cm then find its volume when its height is 105 cm.
4. A conical container is fully filled with petrol. The radius is 10m and the height is 15 m. If the container can release the petrol through its bottom at the rate of 25 cu. meter per minute, in how many minutes the container will be emptied. Round off your answer to the nearest minute.
5. A right angled triangle whose sides are 6 cm, 8 cm and 10 cm is revolved about the sides containing the right angle in two ways. Find the difference in volumes of the two solids so formed.
6. The volumes of two cones of same base radius are  $3600 \text{ cm}^3$  and  $5040 \text{ cm}^3$ . Find the ratio of heights.
7. If the ratio of radii of two spheres is 4:7, find the ratio of their volumes.
8. A solid sphere and a solid hemisphere have equal total surface area. Prove that the ratio of their volume is  $3\sqrt{3} : 4$ .
9. The outer and the inner surface areas of a spherical copper shell are  $576\pi \text{ cm}^2$  and  $324\pi \text{ cm}^2$  respectively. Find the volume of the material required to make the shell.
10. A container open at the top is in the form of a frustum of a cone of height 16 cm with radii of its lower and upper ends are 8 cm and 20 cm respectively. Find the cost of milk which can completely fill a container at the rate of ₹40 per litre.

### 7.4 Volume and Surface Area of Combined Solids

Observe the shapes given (Fig.7.37).

The shapes provided lead to the following definitions of 'Combined Solid'.



A combined solid is said to be a solid formed by combining two or more solids.

The concept of combined solids is useful in the fields like doll making, building construction, carpentry, etc.

To calculate the surface area of the combined solid, we should only calculate the areas that are visible to our eyes. For example, if a cone is surmounted by a hemisphere, we need

to just find out the C.S.A. of the hemisphere and C.S.A. of the cone separately and add them together. Note that we are leaving the base area of both the cone and the hemisphere since both the bases are attached together and are not visible.

But, the volume of the solid formed by joining two basic solids will be the sum of the volumes of the individual solids.

**Example 7.24** A toy is in the shape of a cylinder surmounted by a hemisphere. The height of the toy is 25 cm. Find the total surface area of the toy if its common diameter is 12 cm.

**Solution** Let  $r$  and  $h$  be the radius and height of the cylinder respectively.

Given that, diameter  $d = 12$  cm, radius  $r = 6$  cm

Total height of the toy is 25 cm

Therefore, height of the cylindrical portion =  $25 - 6 = 19$  cm

T.S.A. of the toy = C.S.A. of the cylinder + C.S.A. of the hemisphere  
+ Base Area of the cylinder

$$\begin{aligned} &= 2\pi rh + 2\pi r^2 + \pi r^2 \\ &= \pi r(2h + 3r) \text{ sq. units} \\ &= \frac{22}{7} \times 6 \times (38 + 18) \\ &= \frac{22}{7} \times 6 \times 56 = 1056 \end{aligned}$$

Therefore, T.S.A. of the toy is  $1056 \text{ cm}^2$

**Example 7.25** A jewel box (Fig. 7.39) is in the shape of a cuboid of dimensions  $30 \text{ cm} \times 15 \text{ cm} \times 10 \text{ cm}$  surmounted by a half part of a cylinder as shown in the figure. Find the volume of the box.

**Solution** Let  $l$ ,  $b$  and  $h_1$  be the length, breadth and height of the cuboid. Also let us take  $r$  and  $h_2$  be the radius and height of the cylinder.

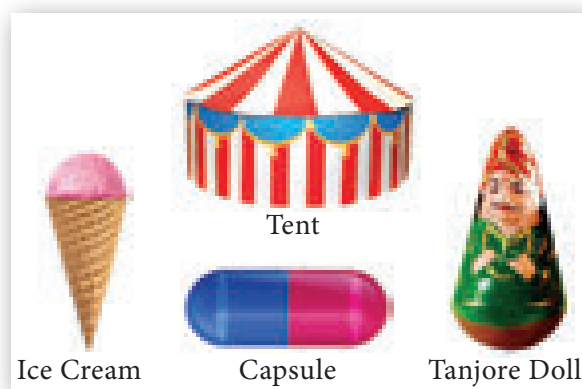

Fig. 7.37

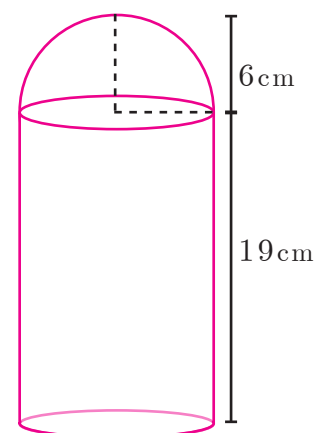

Fig. 7.38



Fig. 7.39

$$\begin{aligned}
 \text{Now, Volume of the box} &= \text{Volume of the cuboid} + \frac{1}{2} (\text{Volume of cylinder}) \\
 &= (l \times b \times h_1) + \frac{1}{2} (\pi r^2 h_2) \text{ cu. units} \\
 &= (30 \times 15 \times 10) + \frac{1}{2} \left( \frac{22}{7} \times \frac{15}{2} \times \frac{15}{2} \times 30 \right) \\
 &= 4500 + 2651.79 = 7151.79
 \end{aligned}$$

Therefore, Volume of the box = 7151.79 cm<sup>3</sup>

**Example 7.26** Arul has to make arrangements for the accommodation of 150 persons for his family function. For this purpose, he plans to build a tent which is in the shape of cylinder surmounted by a cone. Each person occupies 4 sq. m of the space on ground and 40 cu. meter of air to breathe. What should be the height of the conical part of the tent if the height of cylindrical part is 8 m?

**Solution** Let  $h_1$  and  $h_2$  be the height of cylinder and cone respectively.

$$\begin{aligned}
 \text{Area for one person} &= 4 \text{ sq. m} \\
 \text{Total number of persons} &= 150 \\
 \text{Therefore, total base area} &= 150 \times 4 \\
 \pi r^2 &= 600 \quad \dots (1)
 \end{aligned}$$

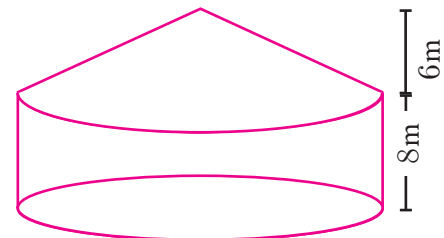

Fig. 7.40

Volume of air required for 1 person = 40 m<sup>3</sup>

Total Volume of air required for 150 persons = 150 × 40 = 6000 m<sup>3</sup>

$$\begin{aligned}
 \pi r^2 h_1 + \frac{1}{3} \pi r^2 h_2 &= 6000 \\
 \pi r^2 \left( h_1 + \frac{1}{3} h_2 \right) &= 6000 \\
 600 \left( 8 + \frac{1}{3} h_2 \right) &= 6000 \quad \text{[using (1)]} \\
 8 + \frac{1}{3} h_2 &= \frac{6000}{600} \\
 \frac{1}{3} h_2 &= 10 - 8 = 2 \\
 h_2 &= 6 \text{ m}
 \end{aligned}$$

Therefore, the height of the conical tent  $h_2$  is 6 m

**Example 7.27** A funnel consists of a frustum of a cone attached to a cylindrical portion 12 cm long attached at the bottom. If the total height be 20 cm, diameter of the cylindrical portion be 12 cm and the diameter of the top of the funnel be 24 cm. Find the outer surface area of the funnel.



**Solution** Let  $R$ ,  $r$  be the top and bottom radii of the frustum.

Let  $h_1$ ,  $h_2$  be the heights of the frustum and cylinder respectively.

Given that,  $R = 12$  cm,  $r = 6$  cm,  $h_2 = 12$  cm

Now,  $h_1 = 20 - 12 = 8$  cm

Here, Slant height of the frustum  $l = \sqrt{(R - r)^2 + h_1^2}$  units

$$= \sqrt{36 + 64}$$

$$l = 10 \text{ cm}$$

Outer surface area  $= 2\pi r h_2 + \pi(R + r)l$  sq. units

$$= \pi[2rh_2 + (R + r)l]$$

$$= \pi[(2 \times 6 \times 12) + (18 \times 10)]$$

$$= \pi[144 + 180]$$

$$= \frac{22}{7} \times 324 = 1018.28$$

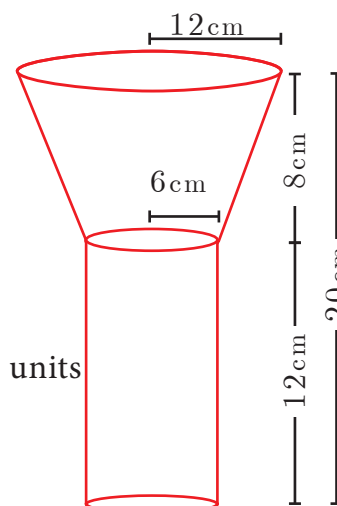

Fig. 7.41

Therefore, outer surface area of the funnel is  $1018.28 \text{ cm}^2$

**Example 7.28** A hemispherical section is cut out from one face of a cubical block (Fig.7.42) such that the diameter  $l$  of the hemisphere is equal to side length of the cube. Determine the surface area of the remaining solid.

**Solution** Let  $r$  be the radius of the hemisphere.

Given that, diameter of the hemisphere = side of the cube =  $l$

Radius of the hemisphere =  $\frac{l}{2}$

TSA of the remaining solid = Surface area of the cubical part  
+ C.S.A. of the hemispherical part  
– Area of the base of the hemispherical part

$$= 6 \times (\text{Edge})^2 + 2\pi r^2 - \pi r^2$$

$$= 6 \times (\text{Edge})^2 + \pi r^2$$

$$= 6 \times (l)^2 + \pi \left(\frac{l}{2}\right)^2 = \frac{1}{4}(24 + \pi)l^2$$

Total surface area of the remaining solid =  $\frac{1}{4}(24 + \pi)l^2$  sq. units

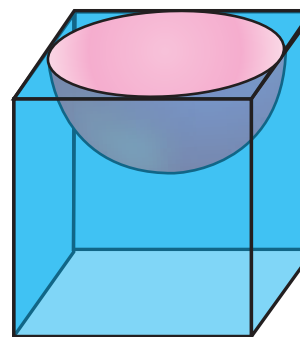

Fig. 7.42



### Activity 4

Combined solids				
List out the solids in each combined solid				
Total Surface Area of the combined solid				

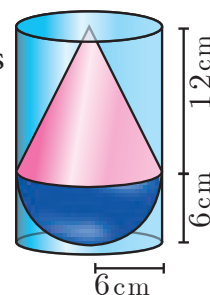
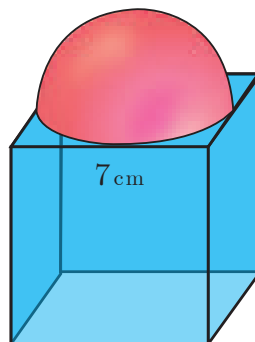

### Exercise 7.3

- A vessel is in the form of a hemispherical bowl mounted by a hollow cylinder. The diameter is 14 cm and the height of the vessel is 13 cm. Find the capacity of the vessel.
- Nathan, an engineering student was asked to make a model shaped like a cylinder with two cones attached at its two ends. The diameter of the model is 3 cm and its length is 12 cm. If each cone has a height of 2 cm, find the volume of the model that Nathan made.
- From a solid cylinder whose height is 2.4 cm and the diameter 1.4 cm, a cone of the same height and same diameter is carved out. Find the volume of the remaining solid to the nearest  $cm^3$ .
- A solid consisting of a right circular cone of height 12 cm and radius 6 cm standing on a hemisphere of radius 6 cm is placed upright in a right circular cylinder full of water such that it touches the bottom. Find the volume of the water displaced out of the cylinder, if the radius of the cylinder is 6 cm and height is 18 cm.
 
- A capsule is in the shape of a cylinder with two hemisphere stuck to each of its ends. If the length of the entire capsule is 12 mm and the diameter of the capsule is 3 mm, how much medicine it can hold?
- As shown in figure a cubical block of side 7 cm is surmounted by a hemisphere. Find the surface area of the solid.
 
- A right circular cylinder just enclose a sphere of radius  $r$  units. Calculate
  - the surface area of the sphere
  - the curved surface area of the cylinder
  - the ratio of the areas obtained in (i) and (ii).



### 7.5 Conversion of Solids from one shape to another with no change in Volume

Conversions or Transformations becomes a common part of our daily life. For example, a gold smith melts a bar of gold to transform it to a jewel. Similarly, a kid playing with clay shapes it into different toys, a carpenter uses the wooden logs to form different house hold articles/furniture. Likewise, the conversion of solids from one shape to another is required for various purposes.

In this section we will be learning problems involving conversions of solids from one shape to another with no change in volume.

**Example 7.29** A metallic sphere of radius 16 cm is melted and recast into small spheres each of radius 2 cm. How many small spheres can be obtained?

**Solution** Let the number of small spheres obtained be  $n$ .

Let  $r$  be the radius of each small sphere and  $R$  be the radius of metallic sphere.

Here,  $R = 16$  cm,  $r = 2$  cm

Now,  $n \times (\text{Volume of a small sphere}) = \text{Volume of big metallic sphere}$

$$n \left( \frac{4}{3} \pi r^3 \right) = \frac{4}{3} \pi R^3$$

$$n \left( \frac{4}{3} \pi \times 2^3 \right) = \frac{4}{3} \pi \times 16^3$$

$$8n = 4096 \Rightarrow n = 512$$

Therefore, there will be 512 small spheres.

**Example 7.30** A cone of height 24 cm is made up of modeling clay. A child reshapes it in the form of a cylinder of same radius as cone. Find the height of the cylinder.

**Solution** Let  $h_1$  and  $h_2$  be the heights of a cone and cylinder respectively.

Also, let  $r$  be the radius of the cone.

Given that, height of the cone  $h_1 = 24$  cm; radius of the cone and cylinder  $r = 6$  cm

Since, Volume of cylinder = Volume of cone

$$\pi r^2 h_2 = \frac{1}{3} \pi r^2 h_1$$

$$h_2 = \frac{1}{3} \times h_1 \Rightarrow h_2 = \frac{1}{3} \times 24 = 8$$

Therefore, height of cylinder is 8 cm

**Example 7.31** A right circular cylindrical container of base radius 6 cm and height 15 cm is full of ice cream. The ice cream is to be filled in cones of height 9 cm and base radius 3 cm, having a hemispherical cap. Find the number of cones needed to empty the container.

**Solution** Let  $h$  and  $r$  be the height and radius of the cylinder respectively.

Given that,  $h = 15$  cm,  $r = 6$  cm

Volume of the container  $V = \pi r^2 h$  cubic units.

$$= \frac{22}{7} \times 6 \times 6 \times 15$$

Let,  $r_1 = 3$  cm,  $h_1 = 9$  cm be the radius and height of the cone.

Also,  $r_1 = 3$  cm is the radius of the hemispherical cap.

Volume of one ice cream cone = (Volume of the cone + Volume of the hemispherical cap)

$$\begin{aligned} &= \frac{1}{3} \pi r_1^2 h_1 + \frac{2}{3} \pi r_1^3 \\ &= \frac{1}{3} \times \frac{22}{7} \times 3 \times 3 \times 9 + \frac{2}{3} \times \frac{22}{7} \times 3 \times 3 \times 3 \\ &= \frac{22}{7} \times 9(3 + 2) = \frac{22}{7} \times 45 \end{aligned}$$

$$\text{Number of cones} = \frac{\text{volume of the cylinder}}{\text{volume of one ice cream cone}}$$

$$\text{Number of ice cream cones needed} = \frac{\frac{22}{7} \times 6 \times 6 \times 15}{\frac{22}{7} \times 45} = 12$$

Thus 12 ice cream cones are required to empty the cylindrical container.



### Activity 5

The adjacent figure shows a cylindrical can with two balls. The can is just large enough so that two balls will fit inside with the lid on. The radius of each tennis ball is 3 cm. Calculate the following

- height of the cylinder.
- radius of the cylinder.
- volume of the cylinder.
- volume of two balls.
- volume of the cylinder not occupied by the balls.
- percentage of the volume occupied by the balls.

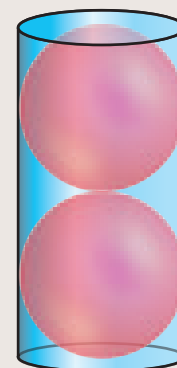

Fig. 7.43



### Exercise 7.4

- An aluminium sphere of radius 12 cm is melted to make a cylinder of radius 8 cm. Find the height of the cylinder.
- Water is flowing at the rate of 15 km per hour through a pipe of diameter 14 cm into a rectangular tank which is 50 m long and 44 m wide. Find the time in which the level of water in the tanks will rise by 21 cm.
- A conical flask is full of water. The flask has base radius  $r$  units and height  $h$  units, the water is poured into a cylindrical flask of base radius  $xr$  units. Find the height of water in the cylindrical flask.

4. A solid right circular cone of diameter 14 cm and height 8 cm is melted to form a hollow sphere. If the external diameter of the sphere is 10 cm, find the internal diameter.
5. Seenu's house has an overhead tank in the shape of a cylinder. This is filled by pumping water from a sump (underground tank) which is in the shape of a cuboid. The sump has dimensions  $2\text{ m} \times 1.5\text{ m} \times 1\text{ m}$ . The overhead tank has its radius of 60 cm and height 105 cm. Find the volume of the water left in the sump after the overhead tank has been completely filled with water from the sump which has been full, initially.
6. The internal and external diameter of a hollow hemispherical shell are 6 cm and 10 cm respectively. If it is melted and recast into a solid cylinder of diameter 14 cm, then find the height of the cylinder.
7. A solid sphere of radius 6 cm is melted into a hollow cylinder of uniform thickness. If the external radius of the base of the cylinder is 5 cm and its height is 32 cm, then find the thickness of the cylinder.
8. A hemispherical bowl is filled to the brim with juice. The juice is poured into a cylindrical vessel whose radius is 50% more than its height. If the diameter is same for both the bowl and the cylinder then find the percentage of juice that can be transferred from the bowl into the cylindrical vessel.



### Exercise 7.5



87M9BR



### Multiple choice questions

1. The curved surface area of a right circular cone of height 15 cm and base diameter 16 cm is  
 (A)  $60\pi\text{ cm}^2$       (B)  $68\pi\text{ cm}^2$       (C)  $120\pi\text{ cm}^2$       (D)  $136\pi\text{ cm}^2$
2. If two solid hemispheres of same base radius  $r$  units are joined together along their bases, then curved surface area of this new solid is  
 (A)  $4\pi r^2$  sq. units      (B)  $6\pi r^2$  sq. units      (C)  $3\pi r^2$  sq. units      (D)  $8\pi r^2$  sq. units
3. The height of a right circular cone whose radius is 5 cm and slant height is 13 cm will be  
 (A) 12 cm      (B) 10 cm      (C) 13 cm      (D) 5 cm
4. If the radius of the base of a right circular cylinder is halved keeping the same height, then the ratio of the volume of the cylinder thus obtained to the volume of original cylinder is  
 (A) 1:2      (B) 1:4      (C) 1:6      (D) 1:8
5. The total surface area of a cylinder whose radius is  $\frac{1}{3}$  of its height is  
 (A)  $\frac{9\pi h^2}{8}$  sq. units      (B)  $24\pi h^2$  sq. units      (C)  $\frac{8\pi h^2}{9}$  sq. units      (D)  $\frac{56\pi h^2}{9}$  sq. units
6. In a hollow cylinder, the sum of the external and internal radii is 14 cm and the width is 4 cm. If its height is 20 cm, the volume of the material in it is  
 (A)  $5600\pi\text{ cm}^3$       (B)  $1120\pi\text{ cm}^3$       (C)  $56\pi\text{ cm}^3$       (D)  $3600\pi\text{ cm}^3$

7. If the radius of the base of a cone is tripled and the height is doubled then the volume is  
 (A) made 6 times (B) made 18 times (C) made 12 times (D) unchanged
8. The total surface area of a hemi-sphere is how much times the square of its radius.  
 (A)  $\pi$  (B)  $4\pi$  (C)  $3\pi$  (D)  $2\pi$
9. A solid sphere of radius  $x$  cm is melted and cast into a shape of a solid cone of same radius. The height of the cone is  
 (A)  $3x$  cm (B)  $x$  cm (C)  $4x$  cm (D)  $2x$  cm
10. A frustum of a right circular cone is of height 16cm with radii of its ends as 8cm and 20cm. Then, the volume of the frustum is  
 (A)  $3328\pi$  cm<sup>3</sup> (B)  $3228\pi$  cm<sup>3</sup> (C)  $3240\pi$  cm<sup>3</sup> (D)  $3340\pi$  cm<sup>3</sup>
11. A shuttle cock used for playing badminton has the shape of the combination of  
 (A) a cylinder and a sphere (B) a hemisphere and a cone  
 (C) a sphere and a cone (D) frustum of a cone and a hemisphere
12. A spherical ball of radius  $r_1$  units is melted to make 8 new identical balls each of radius  $r_2$  units. Then  $r_1 : r_2$  is  
 (A) 2:1 (B) 1:2 (C) 4:1 (D) 1:4
13. The volume (in cm<sup>3</sup>) of the greatest sphere that can be cut off from a cylindrical log of wood of base radius 1 cm and height 5 cm is  
 (A)  $\frac{4}{3}\pi$  (B)  $\frac{10}{3}\pi$  (C)  $5\pi$  (D)  $\frac{20}{3}\pi$
14. The height and radius of the cone of which the frustum is a part are  $h_1$  units and  $r_1$  units respectively. Height of the frustum is  $h_2$  units and radius of the smaller base is  $r_2$  units. If  $h_2 : h_1 = 1 : 2$  then  $r_2 : r_1$  is  
 (A) 1 : 3 (B) 1 : 2 (C) 2 : 1 (D) 3 : 1
15. The ratio of the volumes of a cylinder, a cone and a sphere, if each has the same diameter and same height is  
 (A) 1:2:3 (B) 2:1:3 (C) 1:3:2 (D) 3:1:2

### Unit Exercise - 7



- The barrel of a fountain-pen cylindrical in shape, is 7 cm long and 5 mm in diameter. A full barrel of ink in the pen will be used for writing 330 words on an average. How many words can be written using a bottle of ink containing one fifth of a litre?
- A hemi-spherical tank of radius 1.75 m is full of water. It is connected with a pipe which empties the tank at the rate of 7 litre per second. How much time will it take to empty the tank completely?
- Find the maximum volume of a cone that can be carved out of a solid hemisphere of radius  $r$  units.
- An oil funnel of tin sheet consists of a cylindrical portion 10 cm long attached to a frustum of a cone. If the total height is 22 cm, the diameter of the cylindrical portion

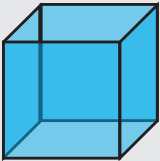
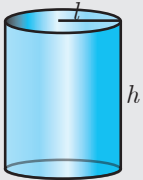
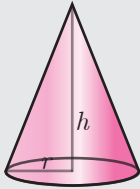
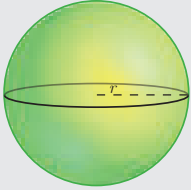

- be 8 cm and the diameter of the top of the funnel be 18 cm, then find the area of the tin sheet required to make the funnel.
- Find the number of coins, 1.5 cm in diameter and 2 mm thick, to be melted to form a right circular cylinder of height 10 cm and diameter 4.5 cm.
  - A hollow metallic cylinder whose external radius is 4.3 cm and internal radius is 1.1 cm and whole length is 4 cm is melted and recast into a solid cylinder of 12 cm long. Find the diameter of solid cylinder.
  - The slant height of a frustum of a cone is 4 m and the perimeter of circular ends are 18 m and 16 m. Find the cost of painting its curved surface area at ₹100 per sq. m.
  - A hemi-spherical hollow bowl has material of volume  $\frac{436\pi}{3}$  cubic cm. Its external diameter is 14 cm. Find its thickness.
  - The volume of a cone is  $1005\frac{5}{7}$  cu. cm. The area of its base is  $201\frac{1}{7}$  sq. cm. Find the slant height of the cone.
  - A metallic sheet in the form of a sector of a circle of radius 21 cm has central angle of  $216^\circ$ . The sector is made into a cone by bringing the bounding radii together. Find the volume of the cone formed.

Points to Remember				
Solid	Figure	Curved surface Area / Lateral surface Area (in sq. units)	Total surface Area (in sq. units)	Volume (in cubic units)
<b>Cuboid</b>		$2h(l + b)$	$2(lb + bh + lh)$	$l \times b \times h$
<b>Cube</b>		$4a^2$	$6a^2$	$a^3$
<b>Right Circular Cylinder</b>		$2\pi rh$	$2\pi r(h + r)$	$\pi r^2 h$
<b>Right Circular Cone</b>		$\pi rl$ $l = \sqrt{r^2 + h^2}$ $l = \text{slant height}$	$\pi rl + \pi r^2$ $= \pi r(l + r)$	$\frac{1}{3} \pi r^2 h$
<b>Sphere</b>		$4\pi r^2$	$4\pi r^2$	$\frac{4}{3} \pi r^3$

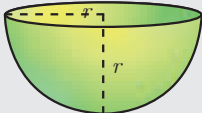
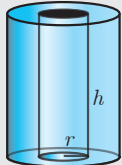
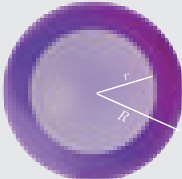
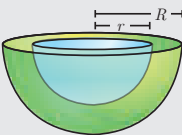
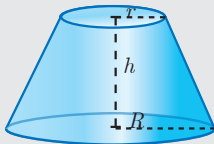
<b>Hemisphere</b>		$2\pi r^2$	$3\pi r^2$	$\frac{2}{3}\pi r^3$
<b>Hollow cylinder</b>		$2\pi(R+r)h$	$2\pi(R+r)(R-r+h)$	$\pi(R^2-r^2)h$
<b>Hollow sphere</b>		$4\pi R^2 =$ outer surface area	$4\pi(R^2+r^2)$	$\frac{4}{3}\pi(R^3-r^3)$
<b>Hollow hemisphere</b>		$2\pi(R^2+r^2)$	$\pi(3R^2+r^2)$	$\frac{2}{3}\pi(R^3-r^3)$
<b>Frustum of right circular cone</b>		$\pi(R+r)l$ where $l = \sqrt{h^2 + (R-r)^2}$	$\pi(R+r)l + \pi R^2 + \pi r^2$	$\frac{1}{3}\pi h[R^2 + r^2 + Rr]$

### ICT CORNER



#### ICT 7.1

**Step 1:** Open the Browser type the URL Link given below (or) Scan the QR Code. GeoGebra work book named "Mensuration\_X" will open. Select the work sheet "Cone-Cylinder relation"

**Step 2:** In the given worksheet you can change the radius and height of the cone-Cylinder by moving the sliders on the left-hand side. Move the vertical slider, to view cone filled in the cylinder and this proves 3 times cone equal to one cylinder of same radius and same height.

#### Step 1

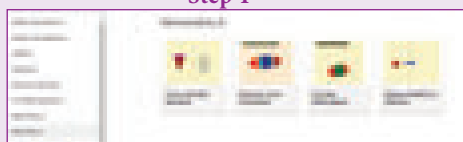

#### Step 2

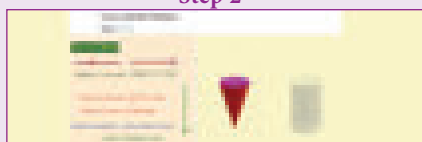

#### Expected results



#### ICT 7.2

**Step 1:** Open the Browser type the URL Link given below (or) Scan the QR Code. GeoGebra work book named "Mensuration\_X" will open. Select the work sheet "Cylinder Hemispheres"

**Step 2:** In the given worksheet you can change the radius of the Hemisphere-Cylinder by moving the sliders on the left-hand side. Move the slider Attach/Detach to see how combined solid is formed. You can rotate 3-D picture to see the faces. Working is given on the left-hand side. Work out and verify your answer.

#### Step 1

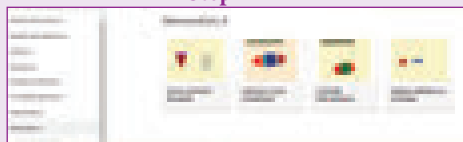

#### Step 2

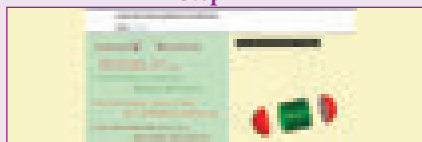

#### Expected results

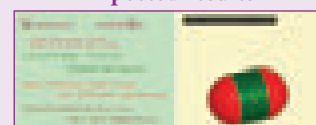

You can repeat the same steps for other activities

<https://www.geogebra.org/m/jfr2zzgy#chapter/356197>

or Scan the QR Code.



# 8

## STATISTICS AND PROBABILITY

*“Life is a School of Probability” - Walter Bagehot*

**Prasanta Chandra Mahalanobis**, born at Kolkata, was an Indian statistician who devised a measure of comparison between two data sets. He introduced innovative techniques for conducting large-scale sample surveys and calculated **acres** and **crop yields** by using the **method of random sampling**. For his pioneering work, he was awarded the Padma Vibhushan, one of India’s highest honours, by the Indian government in 1968 and he is hailed as **“Father of Indian Statistics”**. The Government of India has designated 29th June every year, coinciding with his birth anniversary, as **“National Statistics Day”**.



**Prasanta Chandra Mahalanobis**



### Learning Outcomes

- To recall the measures of central tendency.
- To recall mean for ungrouped and grouped data.
- To understand the concept of dispersion.
- To understand and compute range, standard deviation, variance and coefficient of variation.
- To understand random experiments, sample space and use of a tree diagram.
- To define and describe different types of events of a random experiment.
- To understand addition theorem of probability and apply it in solving some simple problems.



IEEJWZ

### 8.1 Introduction

‘STATISTICS’ is derived from the Latin word ‘status’ which means a political state. Today, statistics has become an integral part of everyone’s life, unavoidable whether making a plan for our future, doing a business, a marketing research or preparing economic reports. It is also extensively used in opinion polls, doing advanced research. The study of statistics is concerned with scientific methods for collecting, organising, summarising, presenting, analysing data and making meaningful decisions. In earlier classes we have studied about collection of data, presenting the data in tabular form, graphical form and calculating the Measures of Central Tendency. Now, in this class, let us study about the Measures of Dispersion.



## Recall

### Measures of Central Tendency

It is often convenient to have one number that represent the whole data. Such a number is called a **Measures of Central Tendency**.

The Measures of Central Tendency usually will be near to the middle value of the data. For a given data there exist several types of measures of central tendencies.

The most common among them are

- Arithmetic Mean
- Median
- Mode

### Thinking Corner

1. Does the mean, median and mode are same for a given data?
2. What is the difference between the arithmetic mean and average?

### Note

- Data : The numerical representation of facts is called data.
- Observation : Each entry in the data is called an observation.
- Variable : The quantities which are being considered in a survey are called variables. Variables are generally denoted by  $x_i, i = 1, 2, 3, \dots, n$ .
- Frequencies : The number of times, a variable occurs in a given data is called the frequency of that variable. Frequencies are generally denoted as  $f_i, i = 1, 2, 3, \dots, n$ .

In this class we have to recall the Arithmetic Mean.

### Arithmetic Mean

The Arithmetic Mean or Mean of the given values is sum of all the observations divided by the total number of observations. It is denoted by  $\bar{x}$  (pronounced as  $x$  bar)

$$\bar{x} = \frac{\text{Sum of all the observations}}{\text{Number of observations}}$$

### Thinking Corner

The mean of  $n$  observations is  $\bar{x}$ , if first term is increased by 1 second term is increased by 2 and so on. What will be the new mean?

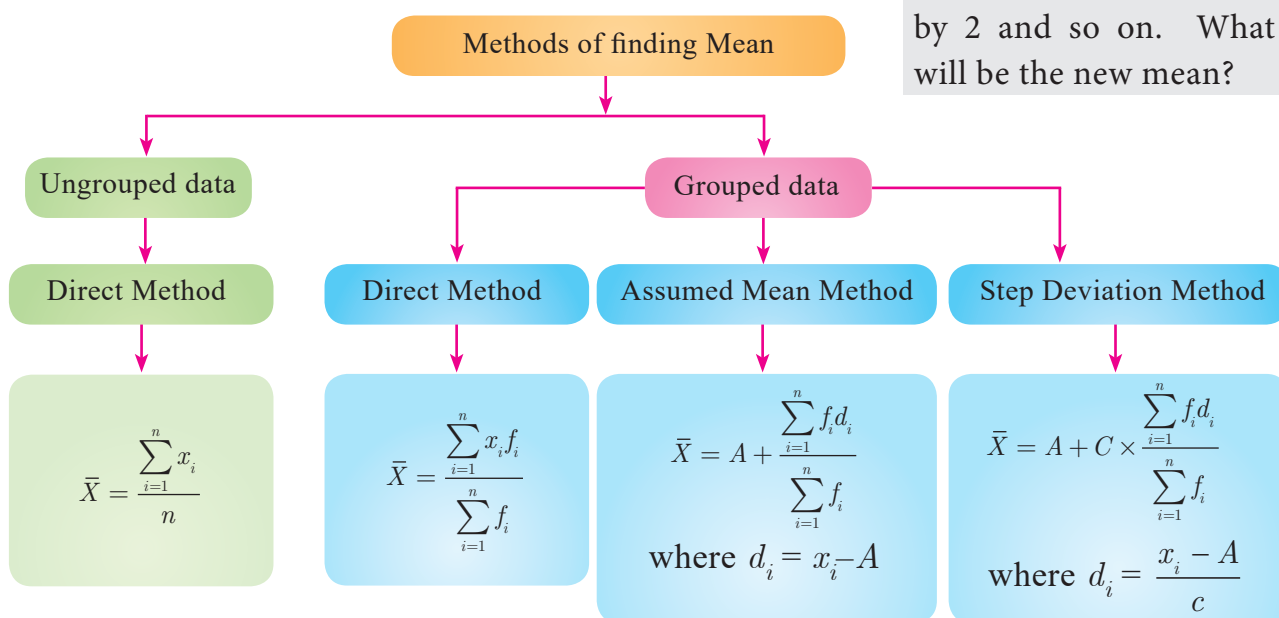

We apply the respective formulae depending upon the information provided in the problem.



## Progress Check

1. The sum of all the observations divided by number of observations is \_\_\_\_\_.
2. If the sum of 10 data values is 265 then their mean is \_\_\_\_\_.
3. If the sum and mean of a data are 407 and 11 respectively, then the number of observations in the data are \_\_\_\_\_.

## 8.2 Measures of Dispersion

The following data provide the runs scored by two batsmen in the last 10 matches.

Batsman A: 25, 20, 45, 93, 8, 14, 32, 87, 72, 4

Batsman B: 33, 50, 47, 38, 45, 40, 36, 48, 37, 26

$$\text{Mean of Batsman A} = \frac{25 + 20 + 45 + 93 + 8 + 14 + 32 + 87 + 72 + 4}{10} = 40$$

$$\text{Mean of Batsman B} = \frac{33 + 50 + 47 + 38 + 45 + 40 + 36 + 48 + 37 + 26}{10} = 40$$

The mean of both datas are same (40), but they differ significantly.

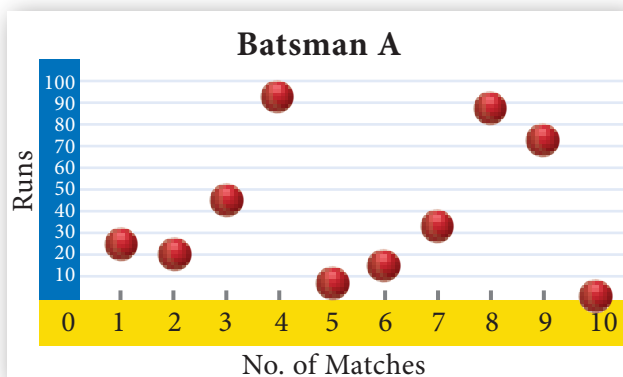

Fig. 8.1(a)

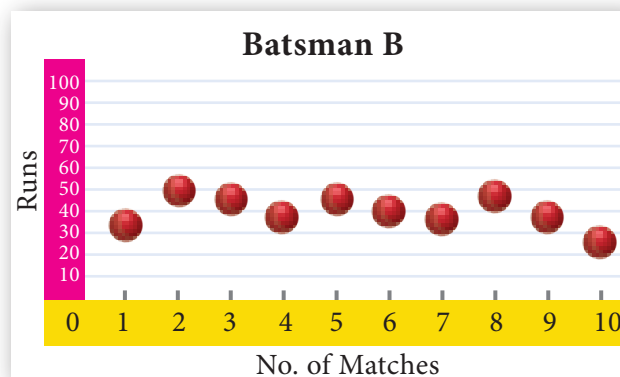

Fig. 8.1(b)

From the above diagrams, we see that runs of batsman *B* are grouped around the mean. But the runs of batsman *A* are scattered from 0 to 100, though they both have same mean.

Thus, some additional statistical information may be required to determine how the values are spread in data. For this, we shall discuss **Measures of Dispersion**.

Dispersion is a measure which gives an idea about the scatteredness of the values.

**Measures of Variation** (or) Dispersion of a data provide an idea of how observations spread out (or) scattered throughout the data.

### Different Measures of Dispersion are

1. Range
2. Mean deviation
3. Quartile deviation
4. Standard deviation
5. Variance
6. Coefficient of Variation

### 8.2.1 Range

The difference between the largest value and the smallest value is called Range.

$$\text{Range } R = L - S$$

$$\text{Coefficient of range} = \frac{L - S}{L + S}$$

where  $L$  - Largest value;  $S$  - Smallest value



#### Progress Check

The range of first 10 prime numbers is \_\_\_\_\_

**Example 8.1** Find the range and coefficient of range of the following data: 25, 67, 48, 53, 18, 39, 44.

**Solution** Largest value  $L = 67$ ; Smallest value  $S = 18$

$$\text{Range } R = L - S = 67 - 18 = 49$$

$$\text{Coefficient of range} = \frac{L - S}{L + S}$$

$$\text{Coefficient of range} = \frac{67 - 18}{67 + 18} = \frac{49}{85} = 0.576$$

**Example 8.2** Find the range of the following distribution.

Age (in years)	16-18	18-20	20-22	22-24	24-26	26-28
Number of students	0	4	6	8	2	2

**Solution** Here Largest value  $L = 28$

$$\text{Smallest value } S = 18$$

$$\text{Range } R = L - S$$

$$R = 28 - 18 = 10 \text{ Years}$$

**Example 8.3** The range of a set of data is 13.67 and the largest value is 70.08. Find the smallest value.

**Solution** Range  $R = 13.67$

$$\text{Largest value } L = 70.08$$

$$\text{Range } R = L - S$$

$$13.67 = 70.08 - S$$

$$S = 70.08 - 13.67 = 56.41$$

Therefore, the smallest value is 56.41.

#### Note

If the frequency of initial class is zero, then the next class will be considered for the calculation of range.

#### Note

The range of a set of data does not give the clear idea about the dispersion of the data from measures of Central Tendency. For this, we need a measure which depend upon the deviation from the measures of Central Tendency.

### 8.2.2 Deviations from the mean

For a given data with  $n$  observations  $x_1, x_2, \dots, x_n$ , the deviations from the mean  $\bar{x}$  are  $x_1 - \bar{x}, x_2 - \bar{x}, \dots, x_n - \bar{x}$ .

### 8.2.3 Squares of deviations from the mean

The squares of deviations from the mean  $\bar{x}$  of the observations  $x_1, x_2, \dots, x_n$  are  $(x_1 - \bar{x})^2, (x_2 - \bar{x})^2, \dots, (x_n - \bar{x})^2$  or  $\sum_{i=1}^n (x_i - \bar{x})^2$

**Note**

We note that  $(x_i - \bar{x}) \geq 0$  for all observations  $x_i, i = 1, 2, 3, \dots, n$ . If the deviations from the mean  $(x_i - \bar{x})$  are small, then the squares of the deviations will be very small.

**8.2.4 Variance**

The mean of the squares of the deviations from the mean is called **Variance**. It is denoted by  $\sigma^2$  (read as sigma square).

$$\begin{aligned} \text{Variance} &= \text{Mean of squares of deviations} \\ &= \frac{(x_1 - \bar{x})^2 + (x_2 - \bar{x})^2 + \dots + (x_n - \bar{x})^2}{n} \\ \text{Variance } \sigma^2 &= \frac{\sum_{i=1}^n (x_i - \bar{x})^2}{n} \end{aligned}$$

**Thinking Corner**

Can variance be negative?

**8.2.5 Standard Deviation**

The positive square root of Variance is called **Standard deviation**. That is, standard deviation is the positive square root of the mean of the squares of deviations of the given values from their mean. It is denoted by  $\sigma$ .

Standard deviation gives a clear idea about how far the values are spreading or deviating from the mean.



Karl Pearson was the first person to use the word standard deviation. German mathematician Gauss used the word Mean error.

$$\text{Standard deviation } \sigma = \sqrt{\frac{\sum_{i=1}^n (x_i - \bar{x})^2}{n}}$$

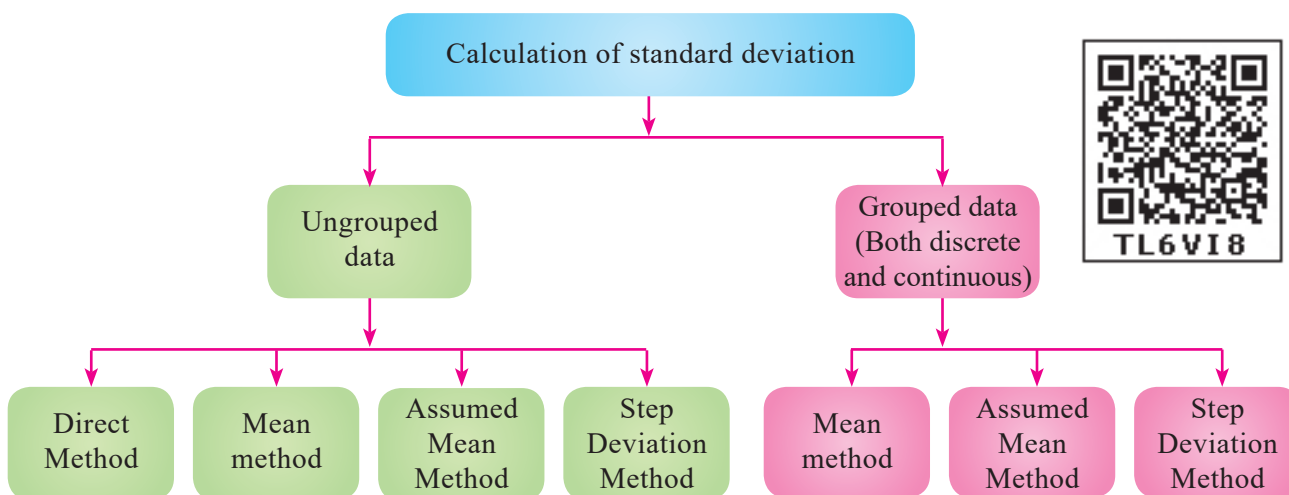

**Calculation of Standard Deviation for ungrouped data**

**(i) Direct Method**

$$\begin{aligned} \text{Standard deviation } \sigma &= \sqrt{\frac{\sum (x_i - \bar{x})^2}{n}} \\ &= \sqrt{\frac{\sum (x_i^2 - 2x_i\bar{x} + \bar{x}^2)}{n}} \end{aligned}$$

**Note**

The standard deviation and mean have same units in which the data are given.

$$= \sqrt{\frac{\sum x_i^2}{n} - 2\bar{x} \frac{\sum x_i}{n} + \frac{\bar{x}^2}{n} \times (1 + 1 + \dots \text{to } n \text{ times})}$$

$$= \sqrt{\frac{\sum x_i^2}{n} - 2\bar{x} \times \bar{x} + \frac{\bar{x}^2}{n} \times n} = \sqrt{\frac{\sum x_i^2}{n} - 2\bar{x}^2 + \bar{x}^2} = \sqrt{\frac{\sum x_i^2}{n} - \bar{x}^2}$$

Standard deviation,  $\sigma = \sqrt{\frac{\sum x_i^2}{n} - \left(\frac{\sum x_i}{n}\right)^2}$

**Note**

- While computing standard deviation, arranging data in ascending order is not mandatory.
- If the data values are given directly then to find standard deviation we can use the

formula  $\sigma = \sqrt{\frac{\sum x_i^2}{n} - \left(\frac{\sum x_i}{n}\right)^2}$

- If the data values are not given directly but the squares of the deviations from the mean of each observation is given then to find standard deviation we can use the

formula  $\sigma = \sqrt{\frac{\sum (x_i - \bar{x})^2}{n}}$ .

**Example 8.4** The number of televisions sold in each day of a week are 13, 8, 4, 9, 7, 12, 10. Find its standard deviation.

**Solution**

$x_i$	$x_i^2$
13	169
8	64
4	16
9	81
7	49
12	144
10	100
$\sum x_i = 63$	$\sum x_i^2 = 623$

Standard deviation

$$\sigma = \sqrt{\frac{\sum x_i^2}{n} - \left(\frac{\sum x_i}{n}\right)^2}$$

$$= \sqrt{\frac{623}{7} - \left(\frac{63}{7}\right)^2}$$

$$= \sqrt{89 - 81} = \sqrt{8}$$

Hence,  $\sigma \simeq 2.83$

**Thinking Corner**

Can the standard deviation be more than the variance?



**Progress Check**

If the variance is 0.49 then the standard deviation is \_\_\_\_\_.

**(ii) Mean method**

Another convenient way of finding standard deviation is to use the following formula.

Standard deviation (by mean method)  $\sigma = \sqrt{\frac{\sum (x_i - \bar{x})^2}{n}}$

If  $d_i = x_i - \bar{x}$  are the deviations, then  $\sigma = \sqrt{\frac{\sum d_i^2}{n}}$

**Example 8.5** The amount of rainfall in a particular season for 6 days are given as 17.8 cm, 19.2 cm, 16.3 cm, 12.5 cm, 12.8 cm and 11.4 cm. Find its standard deviation.

**Solution** Arranging the numbers in ascending order we get, 11.4, 12.5, 12.8, 16.3, 17.8, 19.2. Number of observations  $n = 6$

$$\text{Mean} = \frac{11.4 + 12.5 + 12.8 + 16.3 + 17.8 + 19.2}{6} = \frac{90}{6} = 15$$



$x_i$	$d_i = x_i - \bar{x}$ $= x - 15$	$d_i^2$
11.4	-3.6	12.96
12.5	-2.5	6.25
12.8	-2.2	4.84
16.3	1.3	1.69
17.8	2.8	7.84
19.2	4.2	17.64
		$\Sigma d_i^2 = 51.22$

Standard deviation  $\sigma = \sqrt{\frac{\Sigma d_i^2}{n}}$   
 $= \sqrt{\frac{51.22}{6}} = \sqrt{8.53}$   
Hence,  $\sigma \simeq 2.9$

**(iii) Assumed Mean method**

When the mean value is not an integer (since calculations are very tedious in decimal form) then it is better to use the **assumed mean method** to find the **standard deviation**.

Let  $x_1, x_2, x_3, \dots, x_n$  be the given data values and let  $\bar{x}$  be their mean.

Let  $d_i$  be the deviation of  $x_i$  from the assumed mean  $A$ , which is usually the middle value or near the middle value of the given data.

$$d_i = x_i - A \text{ gives, } x_i = d_i + A \quad \dots(1)$$

$$\begin{aligned} \Sigma d_i &= \Sigma(x_i - A) \\ &= \Sigma x_i - (A + A + A + \dots \text{ to } n \text{ times}) \end{aligned}$$

$$\Sigma d_i = \Sigma x_i - A \times n$$

$$\begin{aligned} \frac{\Sigma d_i}{n} &= \frac{\Sigma x_i}{n} - A \\ \bar{d} &= \bar{x} - A \text{ (or) } \bar{x} = \bar{d} + A \quad \dots(2) \end{aligned}$$

$$\begin{aligned} \text{Standard deviation } \sigma &= \sqrt{\frac{\Sigma(x_i - \bar{x})^2}{n}} = \sqrt{\frac{\Sigma(d_i + A - \bar{d} - A)^2}{n}} \quad \text{(using (1) and (2))} \\ &= \sqrt{\frac{\Sigma(d_i - \bar{d})^2}{n}} = \sqrt{\frac{\Sigma(d_i^2 - 2d_i \times \bar{d} + \bar{d}^2)}{n}} \\ &= \sqrt{\frac{\Sigma d_i^2}{n} - 2\bar{d} \frac{\Sigma d_i}{n} + \frac{\bar{d}^2}{n} (1 + 1 + 1 + \dots \text{ to } n \text{ times})} \\ &= \sqrt{\frac{\Sigma d_i^2}{n} - 2\bar{d} \times \bar{d} + \frac{\bar{d}^2}{n} \times n} \quad \text{(since } \bar{d} \text{ is a constant)} \\ &= \sqrt{\frac{\Sigma d_i^2}{n} - \bar{d}^2} \end{aligned}$$

$$\text{Standard deviation } \sigma = \sqrt{\frac{\Sigma d_i^2}{n} - \left(\frac{\Sigma d_i}{n}\right)^2}$$

**Thinking Corner**

For any collection of  $n$  values, can you find the value of

- (i)  $\Sigma(x_i - \bar{x})$
- (ii)  $(\Sigma x_i) - \bar{x}$

**Example 8.6** The marks scored by 10 students in a class test are 25, 29, 30, 33, 35, 37, 38, 40, 44, 48. Find the standard deviation.

**Solution** The mean of marks is 35.9 which is not an integer. Hence we take assumed mean,  $A = 35$ ,  $n = 10$ .

$x_i$	$d_i = x_i - A$ $d_i = x_i - 35$	$d_i^2$
25	-10	100
29	-6	36
30	-5	25
33	-2	4
35	0	0
37	2	4
38	3	9
40	5	25
44	9	81
48	13	169
	$\Sigma d_i = 9$	$\Sigma d_i^2 = 453$

Standard deviation

$$\begin{aligned}\sigma &= \sqrt{\frac{\Sigma d_i^2}{n} - \left(\frac{\Sigma d_i}{n}\right)^2} \\ &= \sqrt{\frac{453}{10} - \left(\frac{9}{10}\right)^2} \\ &= \sqrt{45.3 - 0.81} \\ &= \sqrt{44.49} \\ \sigma &\simeq 6.67\end{aligned}$$

### (ii) Step deviation method

Let  $x_1, x_2, x_3, \dots, x_n$  be the given data. Let  $A$  be the assumed mean.

Let  $c$  be the common divisor of  $x_i - A$ .

$$\text{Let } d_i = \frac{x_i - A}{c}$$

$$\text{Then } x_i = d_i c + A \quad \dots(1)$$

$$\Sigma x_i = \Sigma (d_i c + A) = c \Sigma d_i + A \times n$$

$$\frac{\Sigma x_i}{n} = c \frac{\Sigma d_i}{n} + A$$

$$\bar{x} = c \bar{d} + A \quad \dots(2)$$

$$x_i - \bar{x} = cd_i + A - c\bar{d} - A = c(d_i - \bar{d}) \quad (\text{using (1) and (2)})$$

$$\sigma = \sqrt{\frac{\Sigma (x_i - \bar{x})^2}{n}} = \sqrt{\frac{\Sigma (c(d_i - \bar{d}))^2}{n}} = \sqrt{\frac{c^2 \Sigma (d_i - \bar{d})^2}{n}}$$

$$\sigma = c \times \sqrt{\frac{\Sigma d_i^2}{n} - \left(\frac{\Sigma d_i}{n}\right)^2}$$

**Note**

We can use any of the above methods for finding the standard deviation

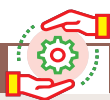

### Activity 1

Find the standard deviation of the marks obtained by you in all five subjects in the quarterly examination and in the midterm test separately. What do you observe from your results.

**Example 8.7** The amount that the children have spent for purchasing some eatables in one day trip of a school are 5, 10, 15, 20, 25, 30, 35, 40. Using step deviation method, find the standard deviation of the amount they have spent.

**Solution** We note that all the observations are divisible by 5. Hence we can use the step deviation method. Let the Assumed mean  $A = 20$ ,  $n = 8$ .

$x_i$	$d_i = x_i - A$ $d_i = x_i - 20$	$d_i = \frac{x_i - A}{c}$ $c = 5$	$d_i^2$
5	-15	-3	9
10	-10	-2	4
15	-5	-1	1
20	0	0	0
25	5	1	1
30	10	2	4
35	15	3	9
40	20	4	16
		$\Sigma d_i = 4$	$\Sigma d_i^2 = 44$

Standard deviation

$$\begin{aligned}\sigma &= \sqrt{\frac{\Sigma d_i^2}{n} - \left(\frac{\Sigma d_i}{n}\right)^2} \times c \\ &= \sqrt{\frac{44}{8} - \left(\frac{4}{8}\right)^2} \times 5 = \sqrt{\frac{11}{2} - \frac{1}{4}} \times 5 \\ &= \sqrt{5.5 - 0.25} \times 5 = 2.29 \times 5 \\ \sigma &\simeq 11.45\end{aligned}$$

**Example 8.8** Find the standard deviation of the following data 7, 4, 8, 10, 11. Add 3 to all the values then find the standard deviation for the new values.

**Solution** Arranging the values in ascending order we get, 4, 7, 8, 10, 11 and  $n = 5$

$x_i$	$x_i^2$
4	16
7	49
8	64
10	100
11	121
$\Sigma x_i = 40$	$\Sigma x_i^2 = 350$

Standard deviation

$$\begin{aligned}\sigma &= \sqrt{\frac{\Sigma x_i^2}{n} - \left(\frac{\Sigma x_i}{n}\right)^2} \\ &= \sqrt{\frac{350}{5} - \left(\frac{40}{5}\right)^2} \\ \sigma &= \sqrt{6} \simeq 2.45\end{aligned}$$

When we add 3 to all the values, we get the new values as 7,10,11,13,14.

$x_i$	$x_i^2$
7	49
10	100
11	121
13	169
14	196
$\Sigma x_i = 55$	$\Sigma x_i^2 = 635$

Standard deviation

$$\begin{aligned}\sigma &= \sqrt{\frac{\Sigma x_i^2}{n} - \left(\frac{\Sigma x_i}{n}\right)^2} \\ &= \sqrt{\frac{635}{5} - \left(\frac{55}{5}\right)^2} \\ \sigma &= \sqrt{6} \simeq 2.45\end{aligned}$$

We see that the standard deviation will not change when we add some fixed constant  $k$  to all the values.

**Example 8.9** Find the standard deviation of the data 2, 3, 5, 7, 8. Multiply each data by 4. Find the standard deviation of the new values.

**Solution** Given,  $n = 5$

$x_i$	$x_i^2$
2	4
3	9
5	25
7	49
8	64
$\Sigma x_i = 25$	$\Sigma x_i^2 = 151$

$$\text{Standard deviation } \sigma = \sqrt{\frac{\Sigma x_i^2}{n} - \left(\frac{\Sigma x_i}{n}\right)^2}$$

$$\sigma = \sqrt{\frac{151}{5} - \left(\frac{25}{5}\right)^2} = \sqrt{30.2 - 25} = \sqrt{5.2} \approx 2.28$$

When we multiply each data by 4, we get the new values as 8, 12, 20, 28, 32.

$x_i$	$x_i^2$
8	64
12	144
20	400
28	784
32	1024
$\Sigma x_i = 100$	$\Sigma x_i^2 = 2416$

$$\text{Standard deviation } \sigma = \sqrt{\frac{\Sigma x_i^2}{n} - \left(\frac{\Sigma x_i}{n}\right)^2}$$

$$= \sqrt{\frac{2416}{5} - \left(\frac{100}{5}\right)^2} = \sqrt{483.2 - 400} = \sqrt{83.2}$$

$$\sigma = \sqrt{16 \times 5.2} = 4\sqrt{5.2} \approx 9.12$$

We see that when we multiply each data by some fixed constant  $k$  the standard deviation also get multiplied by  $k$ .

**Example 8.10** Find the mean and variance of the first  $n$  natural numbers.

**Solution**

$$\begin{aligned} \text{Mean } \bar{x} &= \frac{\text{Sum of all the observations}}{\text{Number of observations}} \\ &= \frac{\Sigma x_i}{n} = \frac{1 + 2 + 3 + \dots + n}{n} = \frac{n(n+1)}{2 \times n} \end{aligned}$$

$$\text{Mean } \bar{x} = \frac{n+1}{2}$$

$$\begin{aligned} \text{Variance } \sigma^2 &= \frac{\Sigma x_i^2}{n} - \left(\frac{\Sigma x_i}{n}\right)^2 = \left[ \frac{\Sigma x_i^2 = 1^2 + 2^2 + 3^2 + \dots + n^2}{n} - \left(\frac{\Sigma x_i}{n}\right)^2 = \frac{(1 + 2 + 3 + \dots + n)^2}{n} \right] \\ &= \frac{n(n+1)(2n+1)}{6 \times n} - \left[ \frac{n(n+1)}{2 \times n} \right]^2 \\ &= \frac{2n^2 + 3n + 1}{6} - \frac{n^2 + 2n + 1}{4} \\ \text{Variance } \sigma^2 &= \frac{4n^2 + 6n + 2 - 3n^2 - 6n - 3}{12} = \frac{n^2 - 1}{12} \end{aligned}$$

### Calculation of Standard deviation for grouped data

(i) Mean method

$$\text{Standard deviation } \sigma = \sqrt{\frac{\Sigma f_i (x_i - \bar{x})^2}{N}}$$

$$d_i = x_i - \bar{x}$$

$$\sigma = \sqrt{\frac{\Sigma f_i d_i^2}{N}}, \text{ where } N = \sum_{i=1}^n f_i$$

( $f_i$  are frequency values of the corresponding data points  $x_i$ )

**Example 8.11** 48 students were asked to write the total number of hours per week they spent on watching television. With this information find the standard deviation of hours spent for watching television.

$x$	6	7	8	9	10	11	12
$f$	3	6	9	13	8	5	4

**Solution**

$x_i$	$f_i$	$x_i f_i$	$d_i = x_i - \bar{x}$	$d_i^2$	$f_i d_i^2$
6	3	18	-3	9	27
7	6	42	-2	4	24
8	9	72	-1	1	9
9	13	117	0	0	0
10	8	80	1	1	8
11	5	55	2	4	20
12	4	48	3	9	36
$N = 48$		$\Sigma x_i f_i = 432$	$\Sigma d_i = 0$		$\Sigma f_i d_i^2 = 124$

Mean

$$\bar{x} = \frac{\Sigma x_i f_i}{N} = \frac{432}{48} = 9 \quad (\because N = \Sigma f_i)$$

Standard deviation

$$\sigma = \sqrt{\frac{\Sigma f_i d_i^2}{N}} = \sqrt{\frac{124}{48}} = \sqrt{2.58}$$

$$\sigma \simeq 1.6$$

**(ii) Assumed Mean method**

Let  $x_1, x_2, x_3, \dots, x_n$  be the given data with frequencies  $f_1, f_2, f_3, \dots, f_n$  respectively. Let  $\bar{x}$  be their mean and  $A$  be the assumed mean.

$$d_i = x_i - A$$

$$\text{Standard deviation, } \sigma = \sqrt{\frac{\Sigma f_i d_i^2}{N} - \left(\frac{\Sigma f_i d_i}{N}\right)^2}$$

**Example 8.12** The marks scored by the students in a slip test are given below. Find the standard deviation of their marks.

$x$	4	6	8	10	12
$f$	7	3	5	9	5

**Solution** Let the assumed mean,  $A = 8$

$x_i$	$f_i$	$d_i = x_i - A$	$f_i d_i$	$f_i d_i^2$
4	7	-4	-28	112
6	3	-2	-6	12
8	5	0	0	0
10	9	2	18	36
12	5	4	20	80
$N = 29$			$\Sigma f_i d_i = 4$	$\Sigma f_i d_i^2 = 240$

Standard deviation

$$\begin{aligned} \sigma &= \sqrt{\frac{\Sigma f_i d_i^2}{N} - \left(\frac{\Sigma f_i d_i}{N}\right)^2} \\ &= \sqrt{\frac{240}{29} - \left(\frac{4}{29}\right)^2} = \sqrt{\frac{240 \times 29 - 16}{29 \times 29}} \\ \sigma &= \sqrt{\frac{6944}{29 \times 29}} \Rightarrow \sigma \simeq 2.87 \end{aligned}$$

**Calculation of Standard deviation for continuous frequency distribution**

**(i) Mean method**

Standard deviation  $\sigma = \sqrt{\frac{\Sigma f_i (x_i - \bar{x})^2}{N}}$  where,  $x_i$  = Middle value of the  $i$ th class.  
 $f_i$  = Frequency of the  $i$ th class.

**(ii) Shortcut method (or) Step deviation method**

To make the calculation simple, we provide the following formula. Let  $A$  be the assumed mean,  $x_i$  be the middle value of the  $i^{\text{th}}$  class and  $c$  is the width of the class interval.

$$d_i = \frac{x_i - A}{c}$$

$$\sigma = c \times \sqrt{\frac{\sum f_i d_i^2}{N} - \left(\frac{\sum f_i d_i}{N}\right)^2}$$

**Example 8.13** Marks of the students in a particular subject of a class are given below. Find its standard deviation.

Marks	0-10	10-20	20-30	30-40	40-50	50-60	60-70
Number of students	8	12	17	14	9	7	4

**Solution** Let the assumed mean,  $A = 35$ ,  $c = 10$

Marks	Mid value ( $x_i$ )	$f_i$	$d_i = x_i - A$	$d_i = \frac{x_i - A}{c}$	$f_i d_i$	$f_i d_i^2$
0-10	5	8	-30	-3	-24	72
10-20	15	12	-20	-2	-24	48
20-30	25	17	-10	-1	-17	17
30-40	35	14	0	0	0	0
40-50	45	9	10	1	9	9
50-60	55	7	20	2	14	28
60-70	65	4	30	3	12	36
		$N = 71$			$\sum f_i d_i = -30$	$\sum f_i d_i^2 = 210$

$$\text{Standard deviation } \sigma = c \times \sqrt{\frac{\sum f_i d_i^2}{N} - \left(\frac{\sum f_i d_i}{N}\right)^2}$$

$$\sigma = 10 \times \sqrt{\frac{210}{71} - \left(-\frac{30}{71}\right)^2} = 10 \times \sqrt{\frac{210}{71} - \frac{900}{5041}}$$

$$= 10 \times \sqrt{2.779} ; \quad \sigma \simeq 16.67$$

**Thinking Corner**

- The standard deviation of a data is 2.8, if 5 is added to all the data values then the new standard deviation is \_\_\_\_.
- If  $S$  is the standard deviation of values  $p, q, r$  then standard deviation of  $p-3, q-3, r-3$  is \_\_\_\_.

**Example 8.14** The mean and standard deviation of 15 observations are found to be 10 and 5 respectively. On rechecking it was found that one of the observation with value 8 was incorrect. Calculate the correct mean and standard deviation if the correct observation value was 23?

**Solution**  $n = 15$ ,  $\bar{x} = 10$ ,  $\sigma = 5$ ;  $\bar{x} = \frac{\sum x}{n}$ ;  $\sum x = 15 \times 10 = 150$

Wrong observation value = 8, Correct observation value = 23.

Correct total =  $150 - 8 + 23 = 165$

$$\text{Correct mean } \bar{x} = \frac{165}{15} = 11$$

$$\text{Standard deviation } \sigma = \sqrt{\frac{\sum x^2}{n} - \left(\frac{\sum x}{n}\right)^2}$$

$$\text{Incorrect value of } \sigma = 5 = \sqrt{\frac{\sum x^2}{15} - (10)^2}$$

$$25 = \frac{\sum x^2}{15} - 100 \Rightarrow \frac{\sum x^2}{15} = 125$$

$$\text{Incorrect value of } \sum x^2 = 1875$$

$$\text{Correct value of } \sum x^2 = 1875 - 8^2 + 23^2 = 2340$$

$$\text{Correct standard deviation } \sigma = \sqrt{\frac{2340}{15} - (11)^2}$$

$$\sigma = \sqrt{156 - 121} = \sqrt{35} \quad \sigma \simeq 5.9$$



### Exercise 8.1

- Find the range and coefficient of range of the following data.
  - 63, 89, 98, 125, 79, 108, 117, 68
  - 43.5, 13.6, 18.9, 38.4, 61.4, 29.8
- If the range and the smallest value of a set of data are 36.8 and 13.4 respectively, then find the largest value.
- Calculate the range of the following data.

Income	400-450	450-500	500-550	550-600	600-650
Number of workers	8	12	30	21	6

- A teacher asked the students to complete 60 pages of a record note book. Eight students have completed only 32, 35, 37, 30, 33, 36, 35 and 37 pages. Find the standard deviation of the pages completed by them.
- Find the variance and standard deviation of the wages of 9 workers given below:  
₹310, ₹290, ₹320, ₹280, ₹300, ₹290, ₹320, ₹310, ₹280.
- A wall clock strikes the bell once at 1 o' clock, 2 times at 2 o' clock, 3 times at 3 o' clock and so on. How many times will it strike in a particular day. Find the standard deviation of the number of strikes the bell make a day.
- Find the standard deviation of first 21 natural numbers.
- If the standard deviation of a data is 4.5 and if each value of the data is decreased by 5, then find the new standard deviation.
- If the standard deviation of a data is 3.6 and each value of the data is divided by 3, then find the new variance and new standard deviation.
- The rainfall recorded in various places of five districts in a week are given below. Find its standard deviation.

Rainfall (in mm)	45	50	55	60	65	70
Number of places	5	13	4	9	5	4

11. In a study about viral fever, the number of people affected in a town were noted as  
Find its standard deviation.

Age in years	0-10	10-20	20-30	30-40	40-50	50-60	60-70
Number of people affected	3	5	16	18	12	7	4

12. The measurements of the diameters (in cms) of the plates prepared in a factory are given below. Find its standard deviation.

Diameter (cm)	21-24	25-28	29-32	33-36	37-40	41-44
Number of plates	15	18	20	16	8	7

13. The time taken by 50 students to complete a 100 meter race are given below. Find its standard deviation.

Time taken (sec)	8.5-9.5	9.5-10.5	10.5-11.5	11.5-12.5	12.5-13.5
Number of students	6	8	17	10	9

14. For a group of 100 candidates the mean and standard deviation of their marks were found to be 60 and 15 respectively. Later on it was found that the scores 45 and 72 were wrongly entered as 40 and 27. Find the correct mean and standard deviation.
15. The mean and variance of seven observations are 8 and 16 respectively. If five of these are 2, 4, 10, 12 and 14, then find the remaining two observations.

### 8.3 Coefficient of Variation

Comparison of two data in terms of measures of central tendencies and dispersions in some cases will not be meaningful, because the variables in the data may not have same units of measurement.

For example consider the two data

	Weight	Price
Mean	8 kg	₹ 85
Standard deviation	1.5 kg	₹ 21.60

Here we cannot compare the standard deviations 1.5kg and ₹21.60. For comparing two or more data for corresponding changes the relative measure of standard deviation, called “Coefficient of variation” is used.

Coefficient of variation of a data is obtained by dividing the standard deviation by the arithmetic mean. It is usually expressed in terms of percentage. This concept is suggested by one of the most prominent Statistician Karl Pearson.

$$\text{Thus, coefficient of variation of first data (C.V}_1) = \frac{\sigma_1}{\bar{x}_1} \times 100\%$$

$$\text{coefficient of variation of second data (C.V}_2) = \frac{\sigma_2}{\bar{x}_2} \times 100\%$$

The data with lesser coefficient of variation is more consistent or stable than the other data.

Consider the two data

A	500	900	800	900	700	400		Mean	Standard deviation
B	300	540	480	540	420	240	A	700	191.5
							B	420	114.9

If we compare the mean and standard deviation of the two data, we think that the two datas are entirely different. But mean and standard deviation of B are 60% of that of A. Because of the smaller mean the smaller standard deviation led to the misinterpretation.



To compare the dispersion of two data, coefficient of variation =  $\frac{\sigma}{\bar{x}} \times 100\%$

The coefficient of variation of  $A = \frac{191.5}{700} \times 100\% = 27.4\%$

The coefficient of variation of  $B = \frac{114.9}{420} \times 100\% = 27.4\%$

Thus the two data have equal coefficient of variation. Since the data have equal coefficient of variation values, we can conclude that one data depends on the other. But the data values of  $B$  are exactly 60% of the corresponding data values of  $A$ . So they are very much related. Thus, we get a confusing situation.

To get clear picture of the given data, we can find their coefficient of variation. This is why we need coefficient of variation.



### Progress Check

1. Coefficient of variation is a relative measure of \_\_\_\_\_.
2. When the standard deviation is divided by the mean we get \_\_\_\_\_.
3. The coefficient of variation depends upon \_\_\_\_\_ and \_\_\_\_\_.
4. If the mean and standard deviation of a data are 8 and 2 respectively then the coefficient of variation is \_\_\_\_\_.
5. When comparing two data, the data with \_\_\_\_\_ coefficient of variation is inconsistent.

**Example 8.15** The mean of a data is 25.6 and its coefficient of variation is 18.75. Find the standard deviation.

**Solution** Mean  $\bar{x} = 25.6$ , Coefficient of variation, C.V. = 18.75

$$\text{Coefficient of variation, C.V.} = \frac{\sigma}{\bar{x}} \times 100\%$$

$$18.75 = \frac{\sigma}{25.6} \times 100 \Rightarrow \sigma = 4.8$$

**Example 8.16** The following table gives the values of mean and variance of heights and weights of the 10th standard students of a school.

	Height	Weight
Mean	155 cm	46.50 kg
Variance	72.25 cm <sup>2</sup>	28.09 kg

Which is more varying than the other?

**Solution** For comparing two data, first we have to find their coefficient of variations

$$\text{Mean } \bar{x}_1 = 155\text{cm, variance } \sigma_1^2 = 72.25 \text{ cm}^2$$

$$\text{Therefore standard deviation } \sigma_1 = 8.5$$

$$\text{Coefficient of variation } C.V._1 = \frac{\sigma_1}{\bar{x}_1} \times 100\%$$

$$C.V._1 = \frac{8.5}{155} \times 100\% = 5.48\% \quad (\text{for heights})$$

$$\text{Mean } \bar{x}_2 = 46.50 \text{ kg, Variance } \sigma_2^2 = 28.09 \text{ kg}^2$$

$$\text{Standard deviation } \sigma_2 = 5.3 \text{ kg}$$

$$\text{Coefficient of variation } C.V_2 = \frac{\sigma_2}{\bar{x}_2} \times 100 \%$$

$$C.V_2 = \frac{5.3}{46.50} \times 100\% = 11.40\% \text{ (for weights)}$$

$$C.V_1 = 5.48\% \text{ and } C.V_2 = 11.40\%$$

Height is more consistent.



### Exercise 8.2

1. The standard deviation and mean of a data are 6.5 and 12.5 respectively. Find the coefficient of variation.
2. The standard deviation and coefficient of variation of a data are 1.2 and 25.6 respectively. Find the value of mean.
3. If the mean and coefficient of variation of a data are 15 and 48 respectively, then find the value of standard deviation.
4. If  $n = 5$ ,  $\bar{x} = 6$ ,  $\Sigma x^2 = 765$ , then calculate the coefficient of variation.
5. Find the coefficient of variation of 24, 26, 33, 37, 29, 31.
6. The time taken (in minutes) to complete a homework by 8 students in a day are given by 38, 40, 47, 44, 46, 43, 49, 53. Find the coefficient of variation.
7. The total marks scored by two students Sathya and Vidhya in 5 subjects are 460 and 480 with standard deviation 4.6 and 2.4 respectively. Who is more consistent in performance?
8. The mean and standard deviation of marks obtained by 40 students of a class in three subjects Mathematics, Science and Social Science are given below.

Subject	Mean	SD
Mathematics	56	12
Science	65	14
Social Science	60	10

Which of the three subjects shows more consistent and which shows less consistent in marks?

## 8.4 Probability

Few centuries ago, gambling and gaming were considered to be fashionable and became widely popular among many men. As the games became more complicated, players were interested in knowing the chances of winning or losing a game from a given situation. In 1654, Chevalier de Mere, a French nobleman with a taste of gambling, wrote a letter to one of the prominent mathematician of the time, Blaise Pascal, seeking his advice about how much dividend he would get for a gambling game played by paying money. Pascal worked this problem mathematically but thought of sharing this problem and see how his good friend and mathematician Pierre de Fermat could solve. Their subsequent correspondences on the issue represented the birth of Probability Theory as a new branch of mathematics.



Blaise Pascal

### Random Experiment

A **random experiment** is an experiment in which

- (i) The set of all possible outcomes are known (ii) Exact outcome is not known.



**Example :** 1. Tossing a coin. 2. Rolling a die. 3. Selecting a card from a pack of 52 cards.

**Sample space**

The set of all possible outcomes in a random experiment is called a **sample space**. It is generally denoted by  $S$ .

**Example :** When we roll a die, the possible outcomes are the face numbers 1,2,3,4,5,6 of the die. Therefore the sample space is  $S = \{1,2,3,4,5,6\}$



Fig. 8.2

**Sample point** Each element of a sample space is called a **sample point**.

**8.4.1 Tree diagram**

Tree diagram allow us to see visually all possible outcomes of an random experiment. Each branch in a tree diagram represent a possible outcome.

**Illustration**

(i) When we throw a die, then from the tree diagram (Fig.8.3), the sample space can be written as  $S = \{1,2,3,4,5,6\}$

Fig. 8.3

(ii) When we toss two coins, then from the tree diagram (Fig.8.4), the sample space can be written as  $S = \{HH, HT, TH, TT\}$

Fig. 8.4



**Progress Check**

1. An experiment in which a particular outcome cannot be predicted is called \_\_\_\_\_.
2. The set of all possible outcomes is called \_\_\_\_\_.

**Example 8.17** Express the sample space for rolling two dice using tree diagram.

**Solution** When we roll two dice, since each die contain 6 faces marked with 1,2,3,4,5,6 the tree diagram will look like

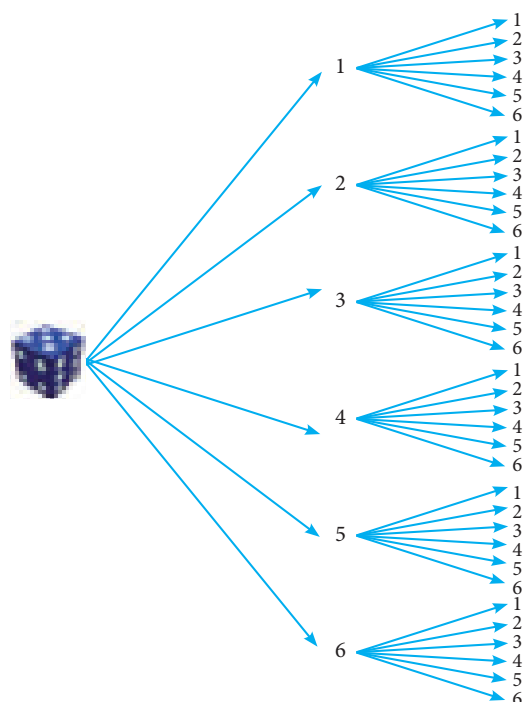

Hence, the sample space can be written as

$$S = \{(1,1), (1,2), (1,3), (1,4), (1,5), (1,6) \\ (2,1), (2,2), (2,3), (2,4), (2,5), (2,6) \\ (3,1), (3,2), (3,3), (3,4), (3,5), (3,6) \\ (4,1), (4,2), (4,3), (4,4), (4,5), (4,6) \\ (5,1), (5,2), (5,3), (5,4), (5,5), (5,6) \\ (6,1), (6,2), (6,3), (6,4), (6,5), (6,6)\}$$





**Event:** In a random experiment, each possible outcome is called an **event**. Thus, an event will be a subset of the sample space.

**Example :** Getting two heads when we toss two coins is an event.

**Trial:** Performing an experiment once is called a **trial**.

**Example :** When we toss a coin thrice, then each toss of a coin is a trial.



Events	Explanation	Example
Equally likely events	Two or more events are said to be <b>equally likely</b> if each one of them has an equal chance of occurring.	Head and tail are equally likely events in <b>tossing a coin</b> .
Certain events	In an experiment, the event which surely occur is called <b>certain event</b> .	When we <b>roll a die</b> , the event of getting any natural number from one to six is a certain event.
Impossible events	In an experiment if an event has no scope to occur then it is called an <b>impossible event</b> .	When we <b>toss two coins</b> , the event of getting three heads is an impossible event.
Mutually exclusive events	Two or more events are said to be <b>mutually exclusive</b> if they don't have common sample points. i.e., events $A, B$ are said to be mutually exclusive if $A \cap B = \phi$ .	When we <b>roll a die</b> the events of getting odd numbers and even numbers are mutually exclusive events.
Exhaustive events	The collection of events whose union is the whole sample space are called <b>exhaustive events</b> .	When we <b>toss a coin twice</b> , the collection of events of getting two heads, exactly one head, no head are exhaustive events.
Complementary events	The <b>complement of an event</b> $A$ is the event representing collection of sample points not in $A$ . It is denoted $A'$ or $A^c$ or $\bar{A}$  The event $A$ and its complement $A'$ are mutually exclusive and exhaustive.	When we <b>roll a die</b> , the event 'rolling a 5 or 6' and the event of rolling a 1, 2, 3 or 4 are complementary events.

**Note**

**Elementary event:** If an event  $E$  consists of only one outcome then it is called an **elementary event**.

**DO YOU KNOW?**

In 1713, Bernoulli was the first to recognise the wide-range applicability of probability in fields outside gambling

### 8.4.2 Probability of an Event

In a random experiment, let  $S$  be the sample space and  $E \subseteq S$ . Then if  $E$  is an **event**, the probability of occurrence of  $E$  is defined as

$$P(E) = \frac{\text{Number of outcomes favourable to occurrence of } E}{\text{Number of all possible outcomes}} = \frac{n(E)}{n(S)}$$

This way of defining the probability is applicable only to finite sample spaces. So in this chapter, we will be dealing problems only with finite sample spaces.

#### Note

- $P(E) = \frac{n(E)}{n(S)}$
- $P(S) = \frac{n(S)}{n(S)} = 1$ . The probability of sure event is 1.
- $P(\phi) = \frac{n(\phi)}{n(s)} = \frac{0}{n(s)} = 0$ . The probability of impossible event is 0.

- Since  $E$  is a subset of  $S$  and  $\phi$  is a subset of any set,

$$\phi \subseteq E \subseteq S$$

$$P(\phi) \leq P(E) \leq P(S)$$

$$0 \leq P(E) \leq 1$$

Therefore, the probability value always lies from 0 to 1.

- The complement event of  $E$  is  $\bar{E}$ .

Let  $P(E) = \frac{m}{n}$  (where  $m$  is the number of favourable outcomes of  $E$  and  $n$  is the total number of possible outcomes).

$$P(\bar{E}) = \frac{\text{Number of outcomes unfavourable to occurrence of } E}{\text{Number of all possible outcomes}}$$

$$P(\bar{E}) = \frac{n-m}{n} = 1 - \frac{m}{n}$$

$$P(\bar{E}) = 1 - P(E)$$

- $P(E) + P(\bar{E}) = 1$

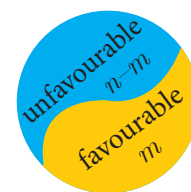

#### Progress Check

Which of the following values cannot be a probability of an event?

- (a)  $-0.0001$     (b)  $0.5$     (c)  $1.001$     (d)  $1$   
 (e)  $20\%$     (f)  $0.253$     (g)  $\frac{1-\sqrt{5}}{2}$     (h)  $\frac{\sqrt{3}+1}{4}$

**Example 8.18** A bag contains 5 blue balls and 4 green balls. A ball is drawn at random from the bag. Find the probability that the ball drawn is (i) blue (ii) not blue.

**Solution** Total number of possible outcomes  $n(S) = 5 + 4 = 9$

(i) Let  $A$  be the event of getting a blue ball.

Number of favourable outcomes for the event  $A$ . Therefore,  $n(A) = 5$

Probability that the ball drawn is blue. Therefore,  $P(A) = \frac{n(A)}{n(S)} = \frac{5}{9}$

(ii)  $\bar{A}$  will be the event of not getting a blue ball. So  $P(\bar{A}) = 1 - P(A) = 1 - \frac{5}{9} = \frac{4}{9}$

**Example 8.19** Two dice are rolled. Find the probability that the sum of outcomes is (i) equal to 4 (ii) greater than 10 (iii) less than 13

**Solution** When we roll two dice, the sample space is given by

$$S = \{ (1,1), (1,2), (1,3), (1,4), (1,5), (1,6) \\ (2,1), (2,2), (2,3), (2,4), (2,5), (2,6) \\ (3,1), (3,2), (3,3), (3,4), (3,5), (3,6) \\ (4,1), (4,2), (4,3), (4,4), (4,5), (4,6) \\ (5,1), (5,2), (5,3), (5,4), (5,5), (5,6) \\ (6,1), (6,2), (6,3), (6,4), (6,5), (6,6) \}; n(S) = 36$$

(i) Let  $A$  be the event of getting the sum of outcome values equal to 4.

Then  $A = \{(1,3), (2,2), (3,1)\}; n(A) = 3$ .

Probability of getting the sum of outcomes equal to 4 is  $P(A) = \frac{n(A)}{n(S)} = \frac{3}{36} = \frac{1}{12}$

(ii) Let  $B$  be the event of getting the sum of outcome values greater than 10.

Then  $B = \{(5,6), (6,5), (6,6)\}; n(B) = 3$

Probability of getting the sum of outcomes greater than 10 is  $P(B) = \frac{n(B)}{n(S)} = \frac{3}{36} = \frac{1}{12}$

(iii) Let  $C$  be the event of getting the sum of outcomes less than 13. Here all the outcomes have the sum value less than 13. Hence  $C = S$ .

Therefore,  $n(C) = n(S) = 36$

Probability of getting the total value less than 13 is  $P(C) = \frac{n(C)}{n(S)} = \frac{36}{36} = 1$ .

**Example 8.20** Two coins are tossed together. What is the probability of getting different faces on the coins?

**Solution** When two coins are tossed together, the sample space is

$$S = \{HH, HT, TH, TT\}; n(S) = 4$$

Let  $A$  be the event of getting different faces on the coins.

$$A = \{HT, TH\}; n(A) = 2$$

Probability of getting different faces on the coins is  $P(A) = \frac{n(A)}{n(S)} = \frac{2}{4} = \frac{1}{2}$

**Example 8.21** From a well shuffled pack of 52 cards, one card is drawn at random. Find the probability of getting (i) red card (ii) heart card (iii) red king (iv) face card (v) number card

**Solution**  $n(S) = 52$

- (i) Let  $A$  be the event of getting a red card.

$$n(A) = 26$$

Probability of getting a red card is

$$P(A) = \frac{26}{52} = \frac{1}{2}$$

- (ii) Let  $B$  be the event of getting a heart card.

$$n(B) = 13$$

Probability of getting a heart card is

$$P(B) = \frac{n(B)}{n(S)} = \frac{13}{52} = \frac{1}{4}$$

- (iii) Let  $C$  be the event of getting a red king card. A red king card can be either a diamond king or a heart king.

$$n(C) = 2$$

Probability of getting a red king card is

$$P(C) = \frac{n(C)}{n(S)} = \frac{2}{52} = \frac{1}{26}$$

- (iv) Let  $D$  be the event of getting a face card. The face cards are Jack ( $J$ ), Queen ( $Q$ ), and King ( $K$ ).

$$n(D) = 4 \times 3 = 12$$

Probability of getting a face card is

$$P(D) = \frac{n(D)}{n(S)} = \frac{12}{52} = \frac{3}{13}$$

- (v) Let  $E$  be the event of getting a number card. The number cards are 2, 3, 4, 5, 6, 7, 8, 9 and 10.

$$n(E) = 4 \times 9 = 36$$

Probability of getting a number card is

$$P(E) = \frac{n(E)}{n(S)} = \frac{36}{52} = \frac{9}{13}$$

Suits of playing cards	Spade ♠	Heart ♥	Clavor ♣	Diamond ♦
Cards of each suit	A	A	A	A
	2	2	2	2
	3	3	3	3
	4	4	4	4
	5	5	5	5
	6	6	6	6
	7	7	7	7
	8	8	8	8
	9	9	9	9
	10	10	10	10
	J	J	J	J
	Q	Q	Q	Q
	K	K	K	K
Set of playing cards in each suit	13	13	13	13

Fig 8.5

**Example 8.22** What is the probability that a leap year selected at random will contain 53 Saturdays.

**Solution** A leap year has 366 days. So it has 52 full weeks and 2 days. 52 Saturdays must be in 52 full weeks.

The possible chances for the remaining two days will be the sample space.

$$S = \{\text{Sun-Mon, Mon-Tue, Tue-Wed, Wed-Thu, Thu-Fri, Fri-Sat, Sat-Sun}\}$$

$$n(S) = 7$$

Let  $A$  be the event of getting 53<sup>rd</sup> Saturday.

Then  $A = \{\text{Fri-Sat, Sat-Sun}\}; n(A) = 2$

**Thinking Corner**

What will be the probability that a non-leap year will have 53 Saturdays?

Probability of getting 53 Saturdays in a leap year is  $P(A) = \frac{n(A)}{n(S)} = \frac{2}{7}$

**Example 8.23** A die is rolled and a coin is tossed simultaneously. Find the probability that the die shows an odd number and the coin shows a head.

**Solution** Sample space

$$S = \{1H, 1T, 2H, 2T, 3H, 3T, 4H, 4T, 5H, 5T, 6H, 6T\};$$

$$n(S) = 12$$

Let  $A$  be the event of getting an odd number and a head.

$$A = \{1H, 3H, 5H\}; n(A) = 3$$

$$P(A) = \frac{n(A)}{n(S)} = \frac{3}{12} = \frac{1}{4}$$

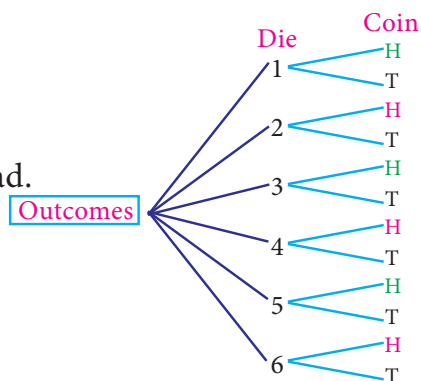

Activity 3	Activity 4
<p>There are three routes <math>R_1, R_2</math> and <math>R_3</math> from Madhu's home to her place of work. There are four parking lots <math>P_1, P_2, P_3, P_4</math> and three entrances <math>B_1, B_2, B_3</math> into the office building. There are two elevators <math>E_1</math> and <math>E_2</math> to her floor. Using the tree diagram explain how many ways can she reach her office?</p>	<p>Collect the details and find the probabilities of</p> <ul style="list-style-type: none"> <li>(i) selecting a boy from your class.</li> <li>(ii) selecting a girl from your class.</li> <li>(iii) selecting a student from tenth standard in your school.</li> <li>(iv) selecting a boy from tenth standard in your school.</li> <li>(v) selecting a girl from tenth standard in your school.</li> </ul>

**Example 8.24** A bag contains 6 green balls, some black and red balls. Number of black balls is as twice as the number of red balls. Probability of getting a green ball is thrice the probability of getting a red ball. Find (i) number of black balls (ii) total number of balls.

**Solution** Number of green balls is  $n(G) = 6$

Let number of red balls is  $n(R) = x$

Therefore, number of black balls is  $n(B) = 2x$

$$\text{Total number of balls } n(S) = 6 + x + 2x = 6 + 3x$$

$$\text{It is given that, } P(G) = 3 \times P(R)$$



$$\frac{6}{6+3x} = 3 \times \frac{x}{6+3x}$$

$$3x = 6 \text{ gives, } x=2$$

- (i) Number of black balls =  $2 \times 2 = 4$
- (ii) Total number of balls =  $6 + (3 \times 2) = 12$

**Example 8.25** A game of chance consists of spinning an arrow which is equally likely to come to rest pointing to one of the numbers 1, 2, 3, ...12. What is the probability that it will point to (i) 7 (ii) a prime number (iii) a composite number?

**Solution** Sample space  $S = \{1,2,3,4,5,6,7,8,9,10,11,12\}$ ;  $n(S) = 12$

- (i) Let  $A$  be the event of resting in 7.  $n(A)=1$

$$P(A) = \frac{n(A)}{n(S)} = \frac{1}{12}$$

- (ii) Let  $B$  be the event that the arrow will come to rest in a prime number.

$$B = \{2,3,5,7,11\}; n(B) = 5$$

$$P(B) = \frac{n(B)}{n(S)} = \frac{5}{12}$$

- (iii) Let  $C$  be the event that arrow will come to rest in a composite number.

$$C = \{4,6,8,9,10,12\}; n(C)=6$$

$$P(C) = \frac{n(C)}{n(S)} = \frac{6}{12} = \frac{1}{2}$$

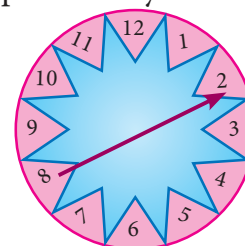

Fig. 8.6

**Thinking Corner**



What is the complement event of an impossible event?



**Exercise 8.3**

1. Write the sample space for tossing three coins using tree diagram.
2. Write the sample space for selecting two balls at a time from a bag containing 6 balls numbered 1 to 6 (using tree diagram).
3. If  $A$  is an event of a random experiment such that  $P(A) : P(\bar{A}) = 17:15$  and  $n(S)=640$  then find (i)  $P(\bar{A})$  (ii)  $n(A)$ .
4. A coin is tossed thrice. What is the probability of getting two consecutive tails?
5. At a fete, cards bearing numbers 1 to 1000, one number on one card are put in a box. Each player selects one card at random and that card is not replaced. If the selected card has a perfect square number greater than 500, the player wins a prize. What is the probability that (i) the first player wins a prize (ii) the second player wins a prize, if the first has won?
6. A bag contains 12 blue balls and  $x$  red balls. If one ball is drawn at random (i) what is the probability that it will be a red ball? (ii) If 8 more red balls are put in the bag, and if the probability of drawing a red ball will be twice that of the probability in (i), then find  $x$ .
7. Two unbiased dice are rolled once. Find the probability of getting
  - (i) a doublet (equal numbers on both dice)
  - (ii) the product as a prime number
  - (iii) the sum as a prime number
  - (iv) the sum as 1

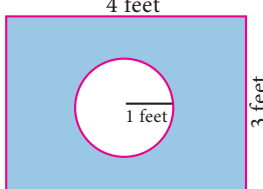
8. Three fair coins are tossed together. Find the probability of getting
  - (i) all heads
  - (ii) atleast one tail
  - (iii) atleast one head
  - (iv) atleast two tails
9. A bag contains 5 red balls, 6 white balls, 7 green balls, 8 black balls. One ball is drawn at random from the bag. Find the probability that the ball drawn is
  - (i) white
  - (ii) black or red
  - (iii) not white
  - (iv) neither white nor black
10. In a box there are 20 non-defective and some defective bulbs. If the probability that a bulb selected at random from the box found to be defective is  $\frac{3}{8}$  then, find the number of defective bulbs.
11. The king and queen of diamonds, queen and jack of hearts, jack and king of spades are removed from a deck of 52 playing cards and then well shuffled. Now one card is drawn at random from the remaining cards. Determine the probability that the card is
  - (i) a clavor
  - (ii) a queen of red card
  - (iii) a king of black card
12. Some boys are playing a game, in which the stone thrown by them landing in a circular region (given in the figure) is considered as win and landing other than the circular region is considered as loss. What is the probability to win the game? ( $\pi = 3.14$ )
 
13. Two customers Priya and Amuthan are visiting a particular shop in the same week (Monday to Saturday). Each is equally likely to visit the shop on any one day as on another day. What is the probability that both will visit the shop on
  - (i) the same day
  - (ii) different days
  - (iii) consecutive days?
14. In a game, the entry fee is ₹150. The game consists of tossing a coin 3 times. Dhana bought a ticket for entry . If one or two heads show, she gets her entry fee back. If she throws 3 heads, she receives double the entry fees. Otherwise she will lose. Find the probability that she
  - (i) gets double entry fee
  - (ii) just gets her entry fee
  - (iii) loses the entry fee.

### 8.5 Algebra of Events

In a random experiment, let  $S$  be the sample space. Let  $A \subseteq S$  and  $B \subseteq S$  be the events in  $S$ . We say that

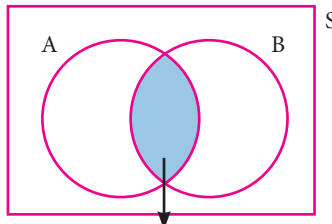
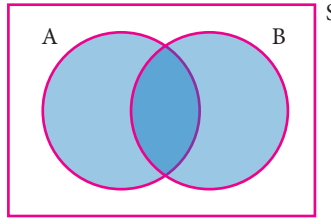
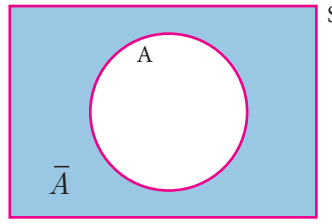
<p>(i) <math>(A \cap B)</math> is an event that occurs only when both <math>A</math> and <math>B</math> occurs.</p>  <p style="text-align: center;"><math>A \cap B</math></p> <p style="text-align: center;">Fig. 8.7(a)</p>	<p>(ii) <math>(A \cup B)</math> is an event that occurs when either one of <math>A</math> or <math>B</math> occurs.</p>  <p style="text-align: center;"><math>A \cup B</math></p> <p style="text-align: center;">Fig. 8.7(b)</p>	<p>(iii) <math>\bar{A}</math> is an event that occurs only when <math>A</math> doesn't occur.</p>  <p style="text-align: center;"><math>\bar{A}</math></p> <p style="text-align: center;">Fig. 8.7(c)</p>
---	--	--

**Note**

- $A \cap \bar{A} = \phi$
- $A \cup \bar{A} = S$
- If  $A, B$  are mutually exclusive events, then  $P(A \cup B) = P(A) + P(B)$
- $P(\text{Union of mutually exclusive events}) = \sum (\text{Probability of events})$

**Theorem 1**

If  $A$  and  $B$  are two events associated with a random experiment, then prove that

- (i)  $P(A \cap \bar{B}) = P(\text{only } A) = P(A) - P(A \cap B)$
- (ii)  $P(\bar{A} \cap B) = P(\text{only } B) = P(B) - P(A \cap B)$

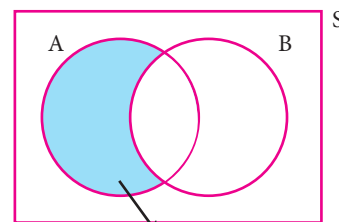

Fig. 8.8

**Proof**

(i) By Distributive property of sets,

1.  $(A \cap B) \cup (A \cap \bar{B}) = A \cap (B \cup \bar{B}) = A \cap S = A$
2.  $(A \cap B) \cap (A \cap \bar{B}) = A \cap (B \cap \bar{B}) = A \cap \phi = \phi$

Therefore, the events  $A \cap B$  and  $A \cap \bar{B}$  are mutually exclusive whose union is  $A$ .

Therefore, 
$$P(A) = P[(A \cap B) \cup (A \cap \bar{B})]$$

$$P(A) = P(A \cap B) + P(A \cap \bar{B})$$

Therefore, 
$$P(A \cap \bar{B}) = P(A) - P(A \cap B)$$

That is, 
$$P(A \cap \bar{B}) = P(\text{only } A) = P(A) - P(A \cap B)$$

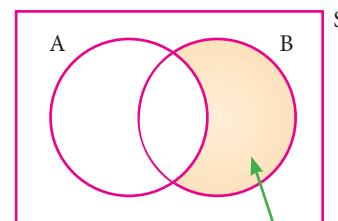

Fig. 8.9

(ii) By Distributive property of sets,

1.  $(A \cap B) \cup (\bar{A} \cap B) = (A \cup \bar{A}) \cap B = S \cap B = B$
2.  $(A \cap B) \cap (\bar{A} \cap B) = (A \cap \bar{A}) \cap B = \phi \cap B = \phi$

Therefore, the events  $A \cap B$  and  $\bar{A} \cap B$  are mutually exclusive whose union is  $B$ .

$$P(B) = P[(A \cap B) \cup (\bar{A} \cap B)]$$

$$P(B) = P(A \cap B) + P(\bar{A} \cap B)$$

Therefore, 
$$P(\bar{A} \cap B) = P(B) - P(A \cap B)$$

That is, 
$$P(\bar{A} \cap B) = P(\text{only } B) = P(B) - P(A \cap B)$$



**Progress Check**

1.  $P(\text{only } A) = \underline{\hspace{2cm}}$ .
2.  $P(\bar{A} \cap B) = \underline{\hspace{2cm}}$ .
3.  $A \cap B$  and  $\bar{A} \cap B$  are  $\underline{\hspace{2cm}}$  events.
4.  $P(\bar{A} \cap \bar{B}) = \underline{\hspace{2cm}}$ .
5. If  $A$  and  $B$  are mutually exclusive events then  $P(A \cap B) = \underline{\hspace{2cm}}$ .
6. If  $P(A \cap B) = 0.3$ ,  $P(\bar{A} \cap B) = 0.45$  then  $P(B) = \underline{\hspace{2cm}}$ .

### 8.6 Addition Theorem of Probability

(i) If  $A$  and  $B$  are any two events then

$$P(A \cup B) = P(A) + P(B) - P(A \cap B)$$

(ii) If  $A, B$  and  $C$  are any three events then

$$P(A \cup B \cup C) = P(A) + P(B) + P(C) - P(A \cap B) - P(B \cap C) - P(A \cap C) + P(A \cap B \cap C)$$

**Proof**

(i) Let  $A$  and  $B$  be any two events of a random experiment with sample space  $S$ .

From the Venn diagram, we have the events only  $A$ ,  $A \cap B$  and only  $B$  are mutually exclusive and their union is  $A \cup B$

$$\begin{aligned} \text{Therefore, } P(A \cup B) &= P[(\text{only } A) \cup (A \cap B) \cup (\text{only } B)] \\ &= P(\text{only } A) + P(A \cap B) + P(\text{only } B) \\ &= [P(A) - P(A \cap B)] + P(A \cap B) + [P(B) - P(A \cap B)] \end{aligned}$$

$$P(A \cup B) = P(A) + P(B) - P(A \cap B)$$

(ii) Let  $A, B, C$  are any three events of a random experiment with sample space  $S$ .

Let  $D = B \cup C$

$$\begin{aligned} P(A \cup B \cup C) &= P(A \cup D) \\ &= P(A) + P(D) - P(A \cap D) \\ &= P(A) + P(B \cup C) - P[A \cap (B \cup C)] \\ &= P(A) + P(B) + P(C) - P(B \cap C) - P[(A \cap B) \cup (A \cap C)] \\ &= P(A) + P(B) + P(C) - P(B \cap C) - P(A \cap B) - P(A \cap C) + P[(A \cap B) \cap (A \cap C)] \end{aligned}$$

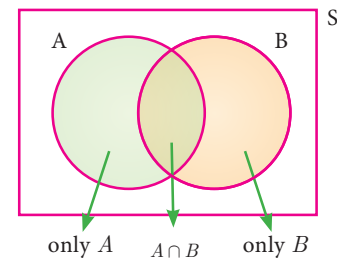

Fig. 8.10

$$P(A \cup B \cup C) = P(A) + P(B) + P(C) - P(A \cap B) - P(B \cap C) - P(C \cap A) + P(A \cap B \cap C)$$



**Activity 5**

The addition theorem of probability can be written easily using the following way.

$$P(A \cup B) = S_1 - S_2$$

$$P(A \cup B \cup C) = S_1 - S_2 + S_3$$

Where  $S_1 \rightarrow$  Sum of probability of events taken one at a time.

$S_2 \rightarrow$  Sum of probability of events taken two at a time.

$S_3 \rightarrow$  Sum of probability of events taken three at a time.

$$P(A \cup B) = \underbrace{P(A) + P(B)}_{S_1} - \underbrace{P(A \cap B)}_{S_2}$$

$$P(A \cup B \cup C) = \underbrace{P(A) + P(B) + P(C)}_{S_1} - \underbrace{(P(A \cap B) + P(B \cap C) + P(A \cap C))}_{S_2} + \underbrace{P(A \cap B \cap C)}_{S_3}$$

Find the probability of  $P(A \cup B \cup C \cup D)$  using the above way. Can you find a pattern for the number of terms in the formula?

**Example 8.26** If  $P(A) = 0.37$ ,  $P(B) = 0.42$ ,  $P(A \cap B) = 0.09$  then find  $P(A \cup B)$ .

**Solution**  $P(A) = 0.37$ ,  $P(B) = 0.42$ ,  $P(A \cap B) = 0.09$

$$P(A \cup B) = P(A) + P(B) - P(A \cap B)$$

$$P(A \cup B) = 0.37 + 0.42 - 0.09 = 0.7$$

**Example 8.27** What is the probability of drawing either a king or a queen in a single draw from a well shuffled pack of 52 cards?

**Solution** Total number of cards = 52

Number of king cards = 4

$$\text{Probability of drawing a king card} = \frac{4}{52}$$

Number of queen cards = 4

$$\text{Probability of drawing a queen card} = \frac{4}{52}$$

Both the events of drawing a king and a queen are mutually exclusive

$$\Rightarrow P(A \cup B) = P(A) + P(B)$$

$$\therefore \text{Probability of drawing either a king or a queen} = \frac{4}{52} + \frac{4}{52} = \frac{2}{13}$$

**Example 8.28** Two dice are rolled together. Find the probability of getting a doublet or sum of faces as 4.

**Solution** When two dice are rolled together, there will be  $6 \times 6 = 36$  outcomes. Let  $S$  be the sample space. Then  $n(S) = 36$

Let  $A$  be the event of getting a doublet and  $B$  be the event of getting face sum 4.

Then  $A = \{(1,1), (2,2), (3,3), (4,4), (5,5), (6,6)\}$

$B = \{(1,3), (2,2), (3,1)\}$

$$\therefore A \cap B = \{(2,2)\}$$

Then,  $n(A) = 6$ ,  $n(B) = 3$ ,  $n(A \cap B) = 1$ .

$$P(A) = \frac{n(A)}{n(S)} = \frac{6}{36}$$

$$P(B) = \frac{n(B)}{n(S)} = \frac{3}{36}$$

$$P(A \cap B) = \frac{n(A \cap B)}{n(S)} = \frac{1}{36}$$

$\therefore P(\text{getting a doublet or a total of 4}) = P(A \cup B)$

$$P(A \cup B) = P(A) + P(B) - P(A \cap B)$$

$$= \frac{6}{36} + \frac{3}{36} - \frac{1}{36} = \frac{8}{36} = \frac{2}{9}$$

Hence, the required probability is  $\frac{2}{9}$ .

### Thinking Corner

$P(A \cup B) + P(A \cap B)$  is \_\_\_\_\_.

**Example 8.29** If  $A$  and  $B$  are two events such that  $P(A) = \frac{1}{4}$ ,  $P(B) = \frac{1}{2}$  and  $P(A \text{ and } B) = \frac{1}{8}$ , find (i)  $P(A \text{ or } B)$  (ii)  $P(\text{not } A \text{ and not } B)$ .

**Solution** (i) 
$$P(A \text{ or } B) = P(A \cup B)$$

$$= P(A) + P(B) - P(A \cap B)$$

$$P(A \text{ or } B) = \frac{1}{4} + \frac{1}{2} - \frac{1}{8} = \frac{5}{8}$$

(ii) 
$$P(\text{not } A \text{ and not } B) = P(\bar{A} \cap \bar{B})$$

$$= P(\overline{A \cup B})$$

$$= 1 - P(A \cup B)$$

$$P(\text{not } A \text{ and not } B) = 1 - \frac{5}{8} = \frac{3}{8}$$

**Example 8.30** A card is drawn from a pack of 52 cards. Find the probability of getting a king or a heart or a red card.

**Solution** Total number of cards = 52;  $n(S) = 52$

Let  $A$  be the event of getting a king card.  $n(A) = 4$

$$P(A) = \frac{n(A)}{n(S)} = \frac{4}{52}$$

Let  $B$  be the event of getting a heart card.  $n(B) = 13$

$$P(B) = \frac{n(B)}{n(S)} = \frac{13}{52}$$

Let  $C$  be the event of getting a red card.  $n(C) = 26$

$$P(C) = \frac{n(C)}{n(S)} = \frac{26}{52}$$

$$P(A \cap B) = P(\text{getting heart king}) = \frac{1}{52}$$

$$P(B \cap C) = P(\text{getting red and heart}) = \frac{13}{52}$$

$$P(A \cap C) = P(\text{getting red king}) = \frac{2}{52}$$

$$P(A \cap B \cap C) = P(\text{getting heart, king which is red}) = \frac{1}{52}$$

Therefore, required probability is

$$P(A \cup B \cup C) = P(A) + P(B) + P(C) - P(A \cap B) - P(B \cap C) - P(C \cap A) + P(A \cap B \cap C)$$

$$= \frac{4}{52} + \frac{13}{52} + \frac{26}{52} - \frac{1}{52} - \frac{13}{52} - \frac{2}{52} + \frac{1}{52} = \frac{28}{52} = \frac{7}{13}$$

Suits of playing cards	Spade	Heart	Clavor	Diamond
Cards of each suit	A	A	A	A
	2	2	2	2
	3	3	3	3
	4	4	4	4
	5	5	5	5
	6	6	6	6
	7	7	7	7
	8	8	8	8
	9	9	9	9
	10	10	10	10
	J	J	J	J
	Q	Q	Q	Q
	K	K	K	K
Set of playing cards in each suit	13	13	13	13

**Example 8.31** In a class of 50 students, 28 opted for NCC, 30 opted for NSS and 18 opted both NCC and NSS. One of the students is selected at random. Find the probability that

(i) The student opted for NCC but not NSS.

- (ii) The student opted for NSS but not NCC.  
 (iii) The student opted for exactly one of them.

**Solution** Total number of students  $n(S) = 50$ .

Let  $A$  and  $B$  be the events of students opted for NCC and NSS respectively.

$$n(A) = 28, n(B) = 30, n(A \cap B) = 18$$

$$P(A) = \frac{n(A)}{n(S)} = \frac{28}{50}$$

$$P(B) = \frac{n(B)}{n(S)} = \frac{30}{50}$$

$$P(A \cap B) = \frac{n(A \cap B)}{n(S)} = \frac{18}{50}$$

- (i) Probability of the students opted for NCC but not NSS

$$P(A \cap \bar{B}) = P(A) - P(A \cap B) = \frac{28}{50} - \frac{18}{50} = \frac{1}{5}$$

- (ii) Probability of the students opted for NSS but not NCC.

$$P(\bar{A} \cap B) = P(B) - P(A \cap B) = \frac{30}{50} - \frac{18}{50} = \frac{6}{25}$$

- (iii) Probability of the students opted for exactly one of them

$$\begin{aligned} &= P[(A \cap \bar{B}) \cup (\bar{A} \cap B)] \\ &= P(A \cap \bar{B}) + P(\bar{A} \cap B) = \frac{1}{5} + \frac{6}{25} = \frac{11}{25} \end{aligned}$$

(Note that  $(A \cap \bar{B}), (\bar{A} \cap B)$  are mutually exclusive events)

**Example 8.32**  $A$  and  $B$  are two candidates seeking admission to IIT. The probability that  $A$  getting selected is 0.5 and the probability that both  $A$  and  $B$  getting selected is 0.3. Prove that the probability of  $B$  being selected is atmost 0.8.

**Solution**  $P(A) = 0.5, P(A \cap B) = 0.3$

We have  $P(A \cup B) \leq 1$

$$P(A) + P(B) - P(A \cap B) \leq 1$$

$$0.5 + P(B) - 0.3 \leq 1$$

$$P(B) \leq 1 - 0.2$$

$$P(B) \leq 0.8$$

Therefore, probability of  $B$  getting selected is atmost 0.8.



### Exercise 8.4

- If  $P(A) = \frac{2}{3}$ ,  $P(B) = \frac{2}{5}$ ,  $P(A \cup B) = \frac{1}{3}$  then find  $P(A \cap B)$ .
- $A$  and  $B$  are two events such that,  $P(A) = 0.42$ ,  $P(B) = 0.48$ , and  $P(A \cap B) = 0.16$ . Find (i)  $P(\text{not } A)$  (ii)  $P(\text{not } B)$  (iii)  $P(A \text{ or } B)$
- If  $A$  and  $B$  are two mutually exclusive events of a random experiment and  $P(\text{not } A) = 0.45$ ,  $P(A \cup B) = 0.65$ , then find  $P(B)$ .
- The probability that atleast one of  $A$  and  $B$  occur is 0.6. If  $A$  and  $B$  occur simultaneously with probability 0.2, then find  $P(\bar{A}) + P(\bar{B})$ .
- The probability of happening of an event  $A$  is 0.5 and that of  $B$  is 0.3. If  $A$  and  $B$  are mutually exclusive events, then find the probability that neither  $A$  nor  $B$  happen.
- Two dice are rolled once. Find the probability of getting an even number on the first die or a total of face sum 8.
- From a well-shuffled pack of 52 cards, a card is drawn at random. Find the probability of it being either a red king or a black queen.
- A box contains cards numbered 3, 5, 7, 9, ... 35, 37. A card is drawn at random from the box. Find the probability that the drawn card have either multiples of 7 or a prime number.
- Three unbiased coins are tossed once. Find the probability of getting atmost 2 tails or atleast 2 heads.
- The probability that a person will get an electrification contract is  $\frac{3}{5}$  and the probability that he will not get plumbing contract is  $\frac{5}{8}$ . The probability of getting atleast one contract is  $\frac{5}{7}$ . What is the probability that he will get both?
- In a town of 8000 people, 1300 are over 50 years and 3000 are females. It is known that 30% of the females are over 50 years. What is the probability that a chosen individual from the town is either a female or over 50 years?
- A coin is tossed thrice. Find the probability of getting exactly two heads or atleast one tail or two consecutive heads.
- If  $A, B, C$  are any three events such that probability of  $B$  is twice as that of probability of  $A$  and probability of  $C$  is thrice as that of probability of  $A$  and if  $P(A \cap B) = \frac{1}{6}$ ,  $P(B \cap C) = \frac{1}{4}$ ,  $P(A \cap C) = \frac{1}{8}$ ,  $P(A \cup B \cup C) = \frac{9}{10}$ ,  $P(A \cap B \cap C) = \frac{1}{15}$ , then find  $P(A), P(B)$  and  $P(C)$ ?
- In a class of 35, students are numbered from 1 to 35. The ratio of boys to girls is 4:3. The roll numbers of students begin with boys and end with girls. Find the probability that a student selected is either a boy with prime roll number or a girl with composite roll number or an even roll number.





### Exercise 8.5



7

### Multiple choice questions

- Which of the following is not a measure of dispersion?  
 (A) Range (B) Standard deviation  
 (C) Arithmetic mean (D) Variance
- The range of the data 8, 8, 8, 8, 8, . . . 8 is  
 (A) 0 (B) 1 (C) 8 (D) 3
- The sum of all deviations of the data from its mean is  
 (A) Always positive (B) always negative (C) zero (D) non-zero integer
- The mean of 100 observations is 40 and their standard deviation is 3. The sum of squares of all observations is  
 (A) 40000 (B) 160900 (C) 160000 (D) 30000
- Variance of first 20 natural numbers is  
 (A) 32.25 (B) 44.25 (C) 33.25 (D) 30
- The standard deviation of a data is 3. If each value is multiplied by 5 then the new variance is  
 (A) 3 (B) 15 (C) 5 (D) 225
- If the standard deviation of  $x, y, z$  is  $p$  then the standard deviation of  $3x + 5, 3y + 5, 3z + 5$  is  
 (A)  $3p + 5$  (B)  $3p$  (C)  $p + 5$  (D)  $9p + 15$
- If the mean and coefficient of variation of a data are 4 and 87.5% then the standard deviation is  
 (A) 3.5 (B) 3 (C) 4.5 (D) 2.5
- Which of the following is incorrect?  
 (A)  $P(A) > 1$  (B)  $0 \leq P(A) \leq 1$  (C)  $P(\phi) = 0$  (D)  $P(A) + P(\bar{A}) = 1$
- The probability a red marble selected at random from a jar containing  $p$  red,  $q$  blue and  $r$  green marbles is  
 (A)  $\frac{q}{p + q + r}$  (B)  $\frac{p}{p + q + r}$  (C)  $\frac{p + q}{p + q + r}$  (D)  $\frac{p + r}{p + q + r}$
- A page is selected at random from a book. The probability that the digit at units place of the page number chosen is less than 7 is  
 (A)  $\frac{3}{10}$  (B)  $\frac{7}{10}$  (C)  $\frac{3}{9}$  (D)  $\frac{7}{9}$
- The probability of getting a job for a person is  $\frac{x}{3}$ . If the probability of not getting the job is  $\frac{2}{3}$  then the value of  $x$  is  
 (A) 2 (B) 1 (C) 3 (D) 1.5

13. Kamalam went to play a lucky draw contest. 135 tickets of the lucky draw were sold. If the probability of Kamalam winning is  $\frac{1}{9}$ , then the number of tickets bought by Kamalam is
- (A) 5 (B) 10 (C) 15 (D) 20
14. If a letter is chosen at random from the English alphabets  $\{a, b, \dots, z\}$ , then the probability that the letter chosen precedes  $x$
- (A)  $\frac{12}{13}$  (B)  $\frac{1}{13}$  (C)  $\frac{23}{26}$  (D)  $\frac{3}{26}$
15. A purse contains 10 notes of ₹2000, 15 notes of ₹500, and 25 notes of ₹200. One note is drawn at random. What is the probability that the note is either a ₹500 note or ₹200 note?
- (A)  $\frac{1}{5}$  (B)  $\frac{3}{10}$  (C)  $\frac{2}{3}$  (D)  $\frac{4}{5}$

### Unit Exercise - 8



1. The mean of the following frequency distribution is 62.8 and the sum of all frequencies is 50. Compute the missing frequencies  $f_1$  and  $f_2$ .

Class Interval	0-20	20-40	40-60	60-80	80-100	100-120
Frequency	5	$f_1$	10	$f_2$	7	8

2. The diameter of circles (in mm) drawn in a design are given below.

Diameters	33-36	37-40	41-44	45-48	49-52
Number of circles	15	17	21	22	25

Calculate the standard deviation.

3. The frequency distribution is given below.

$x$	$k$	$2k$	$3k$	$4k$	$5k$	$6k$
$f$	2	1	1	1	1	1

In the table,  $k$  is a positive integer, has a variance of 160. Determine the value of  $k$ .

4. The standard deviation of some temperature data in degree celsius ( $^{\circ}\text{C}$ ) is 5. If the data were converted into degree Fahrenheit ( $^{\circ}\text{F}$ ) then what is the variance?
5. If for a distribution,  $\sum(x - 5) = 3$ ,  $\sum(x - 5)^2 = 43$ , and total number of observations is 18, find the mean and standard deviation.
6. Prices of peanut packets in various places of two cities are given below. In which city, prices were more stable?

Prices in city A	20	22	19	23	16
Prices in city B	10	20	18	12	15

7. If the range and coefficient of range of the data are 20 and 0.2 respectively, then find the largest and smallest values of the data.

8. If two dice are rolled, then find the probability of getting the product of face value 6 or the difference of face values 5.
9. In a two children family, find the probability that there is at least one girl in a family.
10. A bag contains 5 white and some black balls. If the probability of drawing a black ball from the bag is twice the probability of drawing a white ball then find the number of black balls.
11. The probability that a student will pass the final examination in both English and Tamil is 0.5 and the probability of passing neither is 0.1. If the probability of passing the English examination is 0.75, what is the probability of passing the Tamil examination?
12. The King, Queen and Jack of the suit spade are removed from a deck of 52 cards. One card is selected from the remaining cards. Find the probability of getting (i) a diamond (ii) a queen (iii) a spade (iv) a heart card bearing the number 5.

### Points to Remember

- Range =  $L - S$  ( $L$  - Largest value,  $S$  - Smallest value)
- Coefficient of range =  $\frac{L - S}{L + S}$ ; Variance  $\sigma^2 = \frac{\sum_{i=1}^n (x_i - \bar{x})^2}{n}$
- Standard deviation  $\sigma = \sqrt{\frac{\sum (x_i - \bar{x})^2}{n}}$
- Standard deviation (ungrouped data)
  - (i) Direct method  $\sigma = \sqrt{\frac{\sum x_i^2}{n} - \left(\frac{\sum x_i}{n}\right)^2}$  (ii) Mean method  $\sigma = \sqrt{\frac{\sum d_i^2}{n}}$
  - (iii) Assumed mean method  $\sigma = \sqrt{\frac{\sum d_i^2}{n} - \left(\frac{\sum d_i}{n}\right)^2}$
  - (iv) Step deviation method  $\sigma = c \times \sqrt{\frac{\sum d_i^2}{n} - \left(\frac{\sum d_i}{n}\right)^2}$
- Standard deviation of first  $n$  natural numbers  $\sigma = \sqrt{\frac{n^2 - 1}{12}}$
- Standard deviation (grouped data)
  - (i) Mean method  $\sigma = \sqrt{\frac{\sum f_i d_i^2}{N}}$  (ii) Assumed mean method  $\sigma = \sqrt{\frac{\sum f_i d_i^2}{N} - \left(\frac{\sum f_i d_i}{N}\right)^2}$
  - (iii) Step deviation method  $\sigma = C \times \sqrt{\frac{\sum f_i d_i^2}{N} - \left(\frac{\sum f_i d_i}{N}\right)^2}$
- Coefficient of variation C.V =  $\frac{\sigma}{\bar{x}} \times 100\%$
- If the C.V. value is less, then the observations of corresponding data are consistent. If the C.V. value is more then the observations of corresponding are inconsistent.

- In a random experiment, the set of all outcomes are known but exact outcome is not known.
- The set of all possible outcomes is called sample space.
- A, B are said to be mutually exclusive events if  $A \cap B = \phi$
- Probability of event  $E$  is  $P(E) = \frac{n(E)}{n(S)}$ 
  - (i) The probability of sure event is 1 and the probability of impossible event is 0.
  - (ii)  $0 \leq P(E) \leq 1$  ; (iii)  $P(\bar{E}) = 1 - P(E)$
- If  $A$  and  $B$  are mutually exclusive events then  $P(A \cup B) = P(A) + P(B)$ .
- (i)  $P(A \cap \bar{B}) = P(\text{only } A) = P(A) - P(A \cap B)$   
 (ii)  $P(\bar{A} \cap B) = P(\text{only } B) = P(B) - P(A \cap B)$
- $P(A \cup B) = P(A) + P(B) - P(A \cap B)$ , for any two events  $A, B$ .
- For any three events  $A, B, C$   

$$P(A \cup B \cup C) = P(A) + P(B) + P(C) - P(A \cap B) - P(B \cap C) - P(C \cap A) + P(A \cap B \cap C)$$

ICT CORNER



ICT 8.1

**Step 1:** Open the Browser type the URL Link given below (or) Scan the QR Code. Chapter named “Probability” will open. Select the work sheet “Probability Addition law”

**Step 2:** In the given worksheet you can change the question by clicking on “New Problem”. Move the slider to see the steps.

Step 1	Step 2	Expected results

ICT 8.2

**Step 1:** Open the Browser type the URL Link given below (or) Scan the QR Code. Chapter named “Probability” will open. Select the work sheet “Addition law Mutually Exclusive”

**Step 2:** In the given worksheet you can change the question by clicking on “New Problem”. Click on the check boxes to see the respective answer.

Step 1	Step 2	Expected results

You can repeat the same steps for other activities

<https://www.geogebra.org/m/jfr2zzgy#chapter/359554>  
 or Scan the QR Code.





**Exercise 1.3**

1.  $\{1,2,3,4,\dots\}$ ,  $\{1,2,3,4,\dots\}$ ,  $\{2,4,6,8,\dots\}$ , yes. 2. yes  
 3.(i) 12 (ii)  $4a^2 - 10a + 6$  (iii) 0 (iv)  $x^2 - 7x + 12$   
 4.(i) (a) 9 (b) 6 (c) 6 (d) 0  
 (ii) 9.5 (iii) (a)  $\{x / 0 \leq x \leq 10, x \in R\}$  (b)  $\{x / 0 \leq x \leq 9, x \in R\}$   
 (iv) 5 5. 2 6.(i) -2 (ii)  $\frac{3}{2}$  (iii) 3 (iv)  $\frac{1}{2}$   
 7.  $4x^3 - 96x^2 + 576x$  8. 1 9.  $500t$   
 10.(i) Yes (ii) 0.9, 24.5 (iii) 60.5 inches (iv) 32 cms

**Exercise 1.4**

- 1.(i) Not a function (ii) function (iii) Not a function (iv) function  
 2.(i)  $\{(2,0), (4,1), (6,2), (10,4), (12,5)\}$

(ii)

$x$	2	4	6	10	12
$f(x)$	0	1	2	4	5

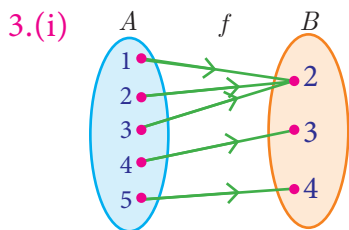
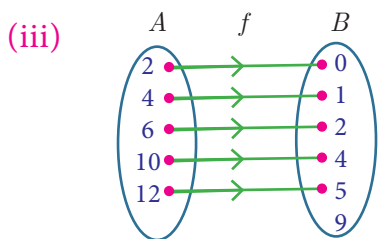
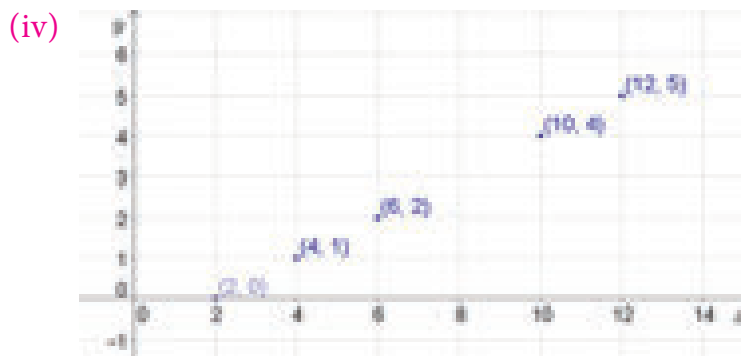

(ii)

$x$	1	2	3	4	5
$f(x)$	2	2	2	3	4

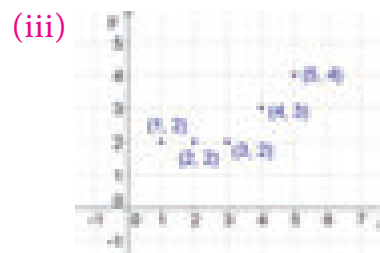

- 6.(i)  $\{1, 8, 27, 64\}$  (ii) one-one and into function  
 7.(i) Bijective function (ii) Not bijective function 8.  $a = -1$  or  $1, b = 1$   
 9.(i) 5 (ii) 2 (iii) -2.5 (iv) 1  
 10.(i) 2 (ii) 10 (iii) 178 (iv)  $\frac{-9}{17}$   
 11. Yes 12.(i)  $32^\circ F$  (ii)  $82.4^\circ F$  (iii)  $14^\circ F$   
 (iv)  $100^\circ C$  (v)  $-40^\circ$

**Exercise 1.5**

- 1.(i)  $x^2 - 6, (x - 6)^2$ ; not equal (ii)  $\frac{2}{2x^2 - 1}, \frac{8}{x^2} - 1$ ; not equal  
 (iii)  $\frac{3-x}{3}, \frac{9-x}{3}$ ; not equal (iv)  $x - 1, x - 1$ ; equal (v)  $4x^2 + 8x + 3, 4x^2$ ; not equal  
 2.(i) -5 (ii)  $\frac{-5}{3}$  4.  $a = \pm 2$   
 5.  $\{y \mid y = 2x^2 + 1, x \in \mathbb{N}\}; \{y \mid y = (2x + 1)^2, x \in \mathbb{N}\}$  6.(i)  $x^4 - 2x^2$   
 (ii)  $[x^4 - 2x^2]^2 - 1$  7.  $f$  is one-one,  $g$  is not one-one,  $f \circ g$  is not one-one 9.  $-4x - 1$

## Exercise 1.6

1	2	3	4	5	6	7	8	9	10	11	12	13	14	15
(C)	(C)	(A)	(B)	(C)	(D)	(C)	(A)	(C)	(C)	(A)	(D)	(C)	(B)	(D)

## Unit exercise-1

1. 1,2 and  $-5,1$       2.  $\{-1,0,1\}, \{(-1,-1),(-1,1),(0,-1),(0,0),(1,-1),(1,0),(1,1)\}$   
 3. (i) 4      (ii)  $\sqrt{2}$       (iii)  $\sqrt{a}$   
 4.  $\{(9,3),(10,5),(11,11),(12,3),(13,13),(14,7),(15,5),(16,2),(17,17)\}, \{2,3,5,7,11,13,17\}$   
 5.  $-1 \leq x \leq 1$       9.(i)  $\frac{-5}{6}$       (ii)  $2(x+1)$       10.(i)  $R - \{9\}$   
 (ii) R      (iii)  $[2, \infty)$       (iv) R

## Exercise 2.1

1. 2, 5, 8, 11, ...      2. 25, 7      6.(i) 4      (ii) 51  
 (iii) 144      (iv) 6      7. 174      8. 2, -1      9. 6

## Exercise 2.2

1. Even number      2. No value      3. 10101      4. 9, 3  
 5. 2,3,5,7 and 3,4,2,1      6. 2040, 34      7. 999720      8. 3647      9. 2520

## Exercise 2.3

- 1.(i) 7      (ii) 5      (iii) 2      (iv) 7      (v) 2  
 2. 3      3. 2,8,14,...      4. 8, 19, 30, ...      5. 11 a.m  
 6. 8 a.m      7. Friday      9. 2      10. 6 a.m, Monday

## Exercise 2.4

- 1.(i) 216,648,1944      (ii)  $-7, -11, -15$       (iii)  $\frac{4}{25}, \frac{5}{36}, \frac{6}{49}$       2.(i)  $-1, 6, 25, 62$   
 (ii) 2, -6, 12, -20      (iii)  $-4, 2, 12, 26$       3.(i)  $n^2 + 1$       (ii)  $\frac{n-1}{n}$   
 (iii)  $5n - 2$       4.(i)  $\frac{15}{4}, \frac{13}{3}$       (ii)  $-12, -117$       5.  $\frac{63}{11}, \frac{225}{31}$       6. 1,1,3,7,17,41

## Exercise 2.5

- 1.(i) A.P      (ii) not an A.P      (iii) A.P      (iv) A.P  
 (v) not an A.P      2.(i) 5, 11, 17, ...      (ii) 7, 2, -3, ...      (iii)  $\frac{3}{4}, \frac{5}{4}, \frac{7}{4}, \dots$   
 3.(i)  $-1, 2$       (ii)  $-3, -7$       4.  $-83$       5. 15  
 6. 93, 99      8. 4      9. 3,17,31      10. 78  
 11. 2,9,16      12. 5:7      13.  $-3^\circ\text{C}, 0^\circ\text{C}, 3^\circ\text{C}, 6^\circ\text{C}, 9^\circ\text{C}$       14. 31 years

## Exercise 2.6

- 1.(i) 3240      (ii) 999      (iii) 721      2. 20      3. 1540  
 5. 612.5      6.50625      7. 168448      8.(i) ₹ 45750      (ii) ₹ 5750      9. 20 months  
 10.(i) 42      (ii) 2130      12.  $\frac{6}{a+b}(24a - 13b)$

## Exercise 2.7

- 1.(i) G.P      (ii) not a G.P      (iii) G.P      (iv) G.P      (v) G.P  
 (vi) not a G.P      (vii) G.P      2.(i) 6,18,54      (ii)  $\sqrt{2}, 2, 2\sqrt{2}$

- (iii) 1000,400,160      3. 1      4. -18      5.(i) 12      (ii) 7      6.  $5 \times (3^{11})$   
 7. 3072      9.  $\frac{9}{2}, 3, 2$  (or)  $2, 3, \frac{9}{2}$       10. ₹ 76577      11. ₹23820, ₹24040

**Exercise 2.8**

- 1.(i)  $\frac{25}{8} \left[ 1 - \left( -\frac{3}{5} \right)^n \right]$       (ii)  $\frac{1024}{3} \left[ 1 - \left( \frac{1}{4} \right)^n \right]$       2. 1820      3. 12  
 4.(i)  $\frac{27}{2}$       (ii) 63      5.  $\frac{1}{4}$       6.(i)  $\frac{4}{9}n - \frac{4 \left[ 1 - \left( \frac{1}{10} \right)^n \right]}{81}$   
 (ii)  $\frac{10(10^n - 1)}{27} - \frac{n}{3}$       7. 3069      8. ₹ 174760      9.  $\frac{41}{333}$

**Exercise 2.9**

- 1.(i) 1830      (ii) 1584      (iii) 3003      (iv) 1240      (v) 3256  
 (vi) 42075      (vii) 1296      2. 105625      3. 210  
 4. 15      5. 9      6.  $4615 \text{ cm}^2$       7.(i)  $4n^3 + 3n^2$       (ii) 2240

**Exercise 2.10**

1	2	3	4	5	6	7	8	9	10	11	12	13	14	15
(C)	(A)	(B)	(C)	(D)	(A)	(D)	(C)	(A)	(C)	(C)	(D)	(B)	(B)	(C)

**Unit exercise-2**

- 2.(i) 35 litres      (ii) 5      (iii) 3      3. 1      6. -78  
 8. ₹1200      9.  $\sqrt{2}, \sqrt{6}, 3\sqrt{2}, \dots$       10. ₹27636

**Exercise 3.1**

- 1.(i) 2, -1, 4      (ii)  $\frac{1}{2}, \frac{1}{3}, \frac{1}{4}$       (iii) 35, 30, 25  
 2.(i) infinitely many solution      (ii) no solution      (iii) unique solution  
 3. 24 years, 51 years, 84 years      4. 137      5. 7, 3, 2

**Exercise 3.2**

- 1.(i)  $x^2 + 2x - 3$       (ii)  $x^2 + 1$       (iii)  $x(x^2 + 4x + 4)$       (iv)  $3(x^2 + 1)$   
 2.(i)  $8x^3y^2$       (ii)  $-36a^3b^2c$       (iii)  $-48m^2n^2$       (iv)  $(p-1)(p-2)(p+2)$   
 (v)  $4(x+3)(2x+1)(x-3)$       (vi)  $2^3x^2(2x-3y)^3(4x^2+6xy+9y^2)$

**Exercise 3.3**

- 1.(i)  $7xy, 105x^2y^2$       (ii)  $(x+1), (x-1)(x+1)(x^2+x+1)(x^2-x+1)$   
 (iii)  $x(x+y), xy(x+y)$       2.(i)  $(a+6)(a-2)(a-3)$       (ii)  $x(x-3a)^2(x^2+3ax+9a^2)$   
 3.(i)  $4x^2(x-1)$       (ii)  $x^2 - xy + y^2$       4. (i)  $(a+2)(a-7)$       (ii)  $(x^2 - y^2)(x^2 + xy + y^2)$

**Exercise 3.4**

- 1.(i)  $\frac{x-1}{x}$       (ii)  $\frac{x-9}{x-2}$       (iii)  $\frac{9}{x-1}$       (iv)  $\frac{p+5}{2p(p-4)}$   
 2.(i) -5, 5      (ii) 2, 3      (iii) 1      (iv) 0, -3, 2



## Exercise 3.5

- 1.(i)  $\frac{3x^3z}{5y^3}$  (ii)  $p + 4$  (iii)  $\frac{3t^2}{4}$  2.(i)  $\frac{3x - 4y}{2x - 5}$  (ii)  $\frac{x^2 + xy + y^2}{3(x + 2y)}$   
 3.(i)  $-5$  (ii)  $\frac{b - 4}{b + 2}$  (iii)  $\frac{3y}{x - 3}$  (iv)  $\frac{4(2t - 1)}{3}$  4.  $\frac{4}{9}$  5.  $x^2 + 4x + 4$

## Exercise 3.6

- 1.(i)  $\frac{2x}{x - 2}$  (ii)  $\frac{2x^2 + 2x - 7}{(x + 3)(x - 2)}$  (iii)  $x^2 + xy + y^2$  2.(i)  $\frac{2(x - 2)}{x - 4}$  (ii)  $\frac{1 - x}{1 + x}$   
 3.  $\frac{2x^3 + 1}{(x^2 + 2)^2}$  4.  $\frac{x + 1}{x^2 - 2x + 4}$  5.  $\frac{(4x^2 - 1)}{2(4x^2 + 1)}$  7. 2 hrs 24 minutes 8. 30 kgs, 20 kgs

## Exercise 3.7

- 1.(i)  $2 \left| \frac{y^4 z^6}{x^2} \right|$  (ii)  $4 \left| \frac{\sqrt{7x} + \sqrt{2}}{4x - 1} \right|$  (iii)  $\frac{11}{9} \left| \frac{(a + b)^4 (x + y)^4}{(a - b)^6} \right|$  2.(i)  $|2x + 5|$   
 (ii)  $|3x - 4y + 5z|$  (iii)  $|(x - 2)(7x + 1)(4x - 1)|$  (iv)  $\frac{1}{6} |(4x + 3)(3x + 2)(x + 2)|$

## Exercise 3.8

1. (i)  $|x^2 - 6x + 3|$  (ii)  $|2x^2 - 7x - 3|$  (iii)  $|4x^2 + 1|$  (iv)  $|11x^2 - 9x - 12|$   
 2.(i) 49, -42 (ii) 144, 264 3.(i) 30, 9 (ii) 24, -32

## Exercise 3.9

- 1.(i)  $x^2 + 9x + 20 = 0$  (ii)  $3x^2 - 5x + 12 = 0$  (iii)  $2x^2 + 3x - 2 = 0$   
 (iv)  $x^2 + (2 - a)^2 x + (a + 5)^2 = 0$  2.(i) -3, -28 (ii) -3, 0 (iii)  $-\frac{1}{3}, -\frac{10}{3}$  (iv)  $\frac{1}{3}, -\frac{4}{3}$

## Exercise 3.10

- 1.(i)  $-\frac{1}{4}, 2$  (ii)  $-2, \frac{9}{2}$  (iii) -2, 9 (iv)  $-\sqrt{2}, \frac{-5}{\sqrt{2}}$  (v)  $\frac{1}{4}, \frac{1}{4}$  2. 6

## Exercise 3.11

- 1.(i)  $\frac{2}{3}, \frac{2}{3}$  (ii) -1, 3 2.(i)  $2, \frac{1}{2}$  (ii)  $\frac{3 + \sqrt{3}}{\sqrt{2}}, \frac{3 - \sqrt{3}}{\sqrt{2}}$   
 (iii) -1,  $\frac{23}{3}$  (iv)  $\frac{a + b}{6}, \frac{a - b}{6}$  3. 3.75 seconds

## Exercise 3.12

1. 5,  $-\frac{1}{5}$  2. 1.5 m 3. 45 km/hr 4. 20 years, 10 years  
 5. Yes, 12 m, 16 m 6. 72 7. 28 m, 42 m 8. 2 m 9. 7 cm

## Exercise 3.13

- 1.(i) Real and unequal (ii) Real and unequal (iii) Not real  
 (iv) Real and equal (v) Real and equal 2.(i) 2, 3 (ii)  $1, \frac{1}{9}$

## Exercise 3.14

- 1.(i)  $\frac{(\alpha + \beta)^2 - 2\alpha\beta}{3\alpha\beta}$  (ii)  $\frac{\alpha + \beta}{(\alpha\beta)^2}$  (iii)  $9\alpha\beta - 3(\alpha + \beta) + 1$

(iv)  $\frac{(\alpha + \beta)^2 - 2\alpha\beta + 3(\alpha + \beta)}{\alpha\beta}$       2.(i)  $\frac{7}{5}$       (ii)  $\frac{29}{10}$       (iii)  $\frac{13}{6}$   
 3.(i)  $x^2 - 44x + 16 = 0$       (ii)  $x^2 - 3x - 1 = 0$       (iii)  $x^2 - 24x - 64 = 0$   
 4. -15, 15      5. -24, 24      6. -36

**Exercise 3.15**

1. ₹6500, ₹1250      2.  $y=8, x=4$       3.  $y=4.5, x=15$ , 4.  $y=18$  minutes, 10 pipes  
 5. 360, ₹30      6. ₹90, 10 hrs

**Exercise 3.16**

1.(i) Real and unequal roots      (ii) Real and equal roots      (iii) No real roots  
 (iv) Real and unequal roots      (v) Real and equal roots      (vi) Real and unequal roots  
 2. -3, 4      3. No real roots      4. -1  
 5. -4, 1      6. -2, 7      7. -1, 3      8. -2, 3

**Exercise 3.17**

1.(i) 16      (ii)  $4 \times 4$       (iii)  $\sqrt{7}, \frac{\sqrt{3}}{2}, 5, 0, -11, 1$   
 2.  $1 \times 18, 2 \times 9, 3 \times 6, 6 \times 3, 9 \times 2, 18 \times 1$  and  $1 \times 6, 2 \times 3, \frac{2}{3} \times 2, 6 \times 1$

3.(i)  $\begin{pmatrix} 1 & 3 & 5 \\ 0 & 2 & 4 \\ 1 & 1 & 3 \end{pmatrix}$       (ii)  $\begin{pmatrix} \frac{8}{3} & 9 & \frac{64}{3} \\ 9 & \frac{64}{3} & \frac{125}{3} \\ \frac{64}{3} & \frac{125}{3} & 72 \end{pmatrix}$       4.  $\begin{pmatrix} 5 & 1 & 3 \\ 4 & -7 & 8 \\ 3 & 9 & 2 \end{pmatrix}$   
 5.  $\begin{pmatrix} -\sqrt{7} & \sqrt{5} & -\sqrt{3} \\ 3 & -2 & 5 \end{pmatrix}$       7.(i) 3, 12, 3      (ii) 4, 2, 0 or 2, 4, 0      (iii) 2, 4, 3

**Exercise 3.18**

3.  $\begin{pmatrix} 5 & 0 \\ 3 & 9 \\ 2 & 2 \end{pmatrix}, \begin{pmatrix} 2 & 0 \\ 3 & 1 \\ 2 & 2 \end{pmatrix}$       4.(i)  $\begin{pmatrix} 7 & -17 & -37 \\ -39 & -11 & -26 \end{pmatrix}$       (ii)  $\begin{pmatrix} -63 & -15 & -45 \\ 15 & -27 & -60 \end{pmatrix}$   
 5.(i) 4, -10, 12 (ii) -10, 14, 10      6. 4, 6      7. 4      8. -1, 5 and -2, 4

**Exercise 3.19**

1.  $3 \times 3, 4 \times 2, 4 \times 2, 4 \times 1, 1 \times 3$       2.  $p \times r$ , not defined      3. 7, 10  
 4.  $\begin{pmatrix} 12 & 19 \\ 10 & 3 \end{pmatrix}, \begin{pmatrix} -10 & -4 \\ 24 & 25 \end{pmatrix}, AB \neq BA$

**Exercise 3.20**

1	2	3	4	5	6	7	8	9	10	11	12	13	14	15	16	17	18	19	20
(D)	(A)	(B)	(A)	(B)	(C)	(D)	(B)	(C)	(C)	(B)	(A)	(B)	(D)	(B)	(B)	(D)	(B)	(C)	(A)

**Unit exercise-3**

1. 6, 2, 1      2. 42, 78, 30      3. 153      4.  $(ky + x)(k^2x^2 - y^2)$       5.  $x^2 + 2x + 1$       6. (i)  $x^a - 2$   
 (ii)  $-x + \frac{5}{2}$       7.  $\frac{(p + q + r)^2}{2qr}$       8. 11 hrs, 22 hrs, 33 hrs      9.  $|17x^2 - 18x + 19|$       10. 3  
 11. 14 km/hr      12. 120 m, 40 m      13. 14 minutes      14. 25      15.(i)  $x^2 - 6x + 11 = 0$

(ii)  $3x^2 - 2x + 1 = 0$     16.  $3, \frac{9}{4}$     17.(i)  $\begin{pmatrix} 750 & 1500 & 2250 \\ 3750 & 2250 & 750 \end{pmatrix}$     (ii)  $\begin{pmatrix} 8000 & 16000 & 24000 \\ 40000 & 24000 & 8000 \end{pmatrix}$

18.  $\sin \theta$     19. 8, 4    20.  $\begin{pmatrix} 122 & 71 \\ -58 & -34 \end{pmatrix}$

**Exercise 4.1**

- 1.(i) Not similar    (ii) Similar, 2.5    2. 3.3 m    3. 42 m  
 5.  $\frac{15}{13}, \frac{36}{13}$     6. 5.6 cm, 3.25 cm    8. 2.8 cm    9. 2 m

**Exercise 4.2**

- 1.(i) 6.43 cm    (ii) 1    2. 60 cm    5. 4 cm, 4 cm  
 8.(i) Not a bisector    (ii) Bisector    12. 2.1 cm

**Exercise 4.3**

1. 30 m    2. 1 mile    3. 21.74 m    4. 12 cm, 5 cm  
 5. 10 m, 24 m, 26 m    6. 0.8 m

**Exercise 4.4**

1. 7 cm    2. 2 cm    3. 7 cm, 5 cm, 3 cm    4.  $30^\circ$     5.  $130^\circ$   
 6.  $\frac{20}{3}$  cm    7. 10 cm    8. 4.8 cm    10. 2 cm    13. 8.7 cm    14. 10.3 cm    15. 4 cm    16. 6.3 cm

**Exercise 4.5**

1	2	3	4	5	6	7	8	9	10	11	12	13	14	15
(C)	(B)	(D)	(A)	(D)	(A)	(B)	(C)	(A)	(D)	(B)	(B)	(B)	(D)	(A)

**Unit exercise-4**

2.  $\frac{12}{5}$  cm,  $\frac{10}{3}$  cm    5.  $20\sqrt{13}$  km    7. 10 m    8. shadow =  $\frac{4}{11} \times (\text{distance})$     10. 6 units

**Exercise 5.1**

- 1.(i) 24 sq. units    (ii) 11.5 sq. units    2.(i) collinear    (ii) collinear  
 3.(i) 44    (ii) 13    4.(i) 0    (ii)  $\frac{1}{2}$  or  $-1$     5.(i) 35 sq. units    (ii) 34 sq. units  
 6.  $-5$     7. 2,  $-1$     8. 24 sq. units,  $\text{area}(\triangle ABC) = 4 \times \text{area}(\triangle PQR)$     9. 122 sq. units  
 10. 10 cans    11.(i) 3.75 sq. units    (ii) 3 sq. units    (iii) 13.88 sq. units

**Exercise 5.2**

- 1.(i) undefined    (ii) 0    2.(i)  $0^\circ$     (ii)  $45^\circ$     3.(i)  $\frac{1}{\sqrt{5}}$     (ii)  $-\cot \theta$   
 4. 3    6. 7    7.  $\frac{17}{2}$     8. 4    9.(i) yes    (ii) yes    11. 5, 2

**Exercise 5.3**

- 1.(i)  $2y + 3 = 0$     (ii)  $2x - 5 = 0$     2.  $1, 45^\circ, \frac{5}{2}$   
 3.  $x - \sqrt{3}y - 3\sqrt{3} = 0$     4.  $\frac{\sqrt{3} + 3}{2}, \frac{3 + 3\sqrt{3}}{-2}$     5.  $-5$     6.  $x - y - 16 = 0$   
 7.(i)  $16x - 15y - 22 = 0$     (ii)  $4x - 9y + 19 = 0$     8.  $15x - 11y + 46 = 0$   
 9.  $x + 4y - 14 = 0, 3x + 5y - 28 = 0$     10.  $5x + 4y - 3 = 0$   
 11. (i) 1    (ii) 7.5 seconds    (iii) 10 seconds

- 12.(i)  $3x - 2y - 12 = 0$  (ii)  $3x - 20y + 15 = 0$  13.(i) 2, -3  
 (ii) -3, -4 14.(i)  $5x + 2y + 3 = 0$  (ii)  $x + y + 4 = 0$

**Exercise 5.4**

- 1.(i) 0 (ii) undefined 2.(i) 0.7 (ii) 0  
 3.(i) Parallel (ii) Perpendicular 4. 4 5.  $3x + 4y + 7 = 0$   
 6.  $2x + 5y - 2 = 0$  7.  $2x + 5y + 6 = 0$ ,  $5x + y - 48 = 0$  8.  $5x - 3y - 8 = 0$   
 9.  $13x + 5y - 18 = 0$  10.  $49x + 28y - 156 = 0$  11.  $31x + 15y + 30 = 0$   
 12.  $4x + 13y - 9 = 0$

**Exercise 5.5**

1	2	3	4	5	6	7	8	9	10	11	12	13	14	15
(B)	(A)	(B)	(C)	(C)	(D)	(B)	(B)	(A)	(C)	(C)	(A)	(B)	(B)	(B)

**Unit exercise-5**

1. Rhombus 2.  $\left(\frac{7}{2}, \frac{13}{2}\right)$  3. 0 sq.units 4. -5 6.  $2x - 3y - 6 = 0$ ,  $3x - 2y + 6 = 0$   
 7. 1340 litres 8. (-1, -4) 9.  $13x + 13y - 6 = 0$  10.  $119x + 102y - 125 = 0$

**Exercise 6.2**

1.  $30^\circ$  2. 24 m 3. 3.66 m 4. 1.5 m 5.(i) 7 m (ii) 16.39 m 6. 10 m

**Exercise 6.3**

1. 150 m 2. 50 m 3. 32.93 m 4. 2078.4 m 6. 30 Feet / m

**Exercise 6.4**

1. 35.52 m 2. 69.28 m, 160 m 4. 150 m, yes  
 5.(i) 264 m (ii) 198 m (iii) 114.31 m 6.(i) 2.91 km (ii) 6.93 km

**Exercise 6.5**

1	2	3	4	5	6	7	8	9	10	11	12	13	14	15
(B)	(D)	(B)	(A)	(B)	(B)	(A)	(C)	(B)	(D)	(B)	(B)	(D)	(B)	(A)

**Unit exercise-6**

5. 29.28 m/s 6. 1.97 seconds (approx) 7.(i) 24.58 km(approx)  
 (ii) 17.21 km (approx) (iii) 21.41 km (approx) (iv) 23.78 km (approx)  
 8. 200 m 9. 39.19 m

**Exercise 7.1**

1. 25 cm, 35 cm 2. 7 m, 35 m 3. 2992 sq.cm  
 4. CSA of the cone when rotated about PQ is larger. 5. 18.25 m  
 6. 28 caps 7.  $\sqrt{5} : 9$  8. 56.25% 9. ₹ 302.72 10. ₹ 1357.72

**Exercise 7.2**

1. 4.67 m 2. 1 cm 3.  $652190 \text{ cm}^3$  4. 63 minutes (approx)  
 5. 100.58 6. 5:7 7. 64:343 9.  $4186.29 \text{ cm}^3$  10. ₹ 418.36

**Exercise 7.3**

1.  $1642.67 \text{ cm}^3$  2.  $66 \text{ cm}^3$  3.  $2.46 \text{ cm}^3$  4.  $905.14 \text{ cm}^3$   
 5.  $77.78 \text{ mm}^3$  6.  $332.5 \text{ cm}^2$  7.(i)  $4\pi r^2$  sq. units  
 (ii)  $4\pi r^2$  sq. units (iii) 1:1

## Exercise 7.4

1. 36 cm   2. 2 hrs   3.  $\frac{h}{3x^2}$    4. 6 cm   5. 1812000  $cm^3$  / 1812 litre   6. 1.33 cm  
7. 1 cm   8. 100%

## Exercise 7.5

1	2	3	4	5	6	7	8	9	10	11	12	13	14	15
(D)	(A)	(A)	(B)	(C)	(B)	(B)	(C)	(C)	(A)	(D)	(A)	(A)	(B)	(D)

## Unit exercise-7

1. 48000 words   2. 27 minutes (approx.)   3.  $\frac{1}{3}\pi r^3$  cu.units   4. 782.57 sq.cm  
5. 450 coins   6. 4.8 cm   7. ₹ 6800   8. 2 cm   9. 17 cm   10. 2794.18  $cm^3$

## Exercise 8.1

1. (i) 62; 0.33   (ii) 47.8; 0.64   2. 50.2   3. 250   4. 2.34  
5. 222.22, 14.91   6. 6.9   7. 6.05   8. 4.5   9. 1.2, 1.44   10. 7.76   11. 14.6  
12. 6   13. 1.24   14. 60.5, 14.61   15. 6 and 8

## Exercise 8.2

1. 52%   2. 4.69   3. 7.2   4. 180.28%   5. 14.4%   6. 10.07%   7. Vidhya   8. Social, Science

## Exercise 8.3

1.  $\{HHH, HHT, HTH, HTT, THH, THT, TTH, TTT\}$   
2.  $\{(1,2), (1,3), (1,4), (1,5), (1,6), (2,1), (2,3), (2,4), (2,5), (2,6), (3,1), (3,2), (3,4), (3,5), (3,6), (4,1), (4,2), (4,3), (4,5), (4,6), (5,1), (5,2), (5,3), (5,4), (5,6), (6,1), (6,2), (6,3), (6,4), (6,5)\}$   
3. (i)  $\frac{15}{32}$    (ii) 340   4.  $\frac{3}{8}$    5. (i)  $\frac{9}{1000}$    (ii)  $\frac{8}{999}$    6. (i)  $\frac{1}{4}$    (ii)  $x = 4$   
7. (i)  $\frac{1}{6}$    (ii)  $\frac{1}{6}$    (iii)  $\frac{5}{12}$    (iv) 0   8. (i)  $\frac{1}{8}$    (ii)  $\frac{7}{8}$    (iii)  $\frac{1}{2}$    (iv)  $\frac{7}{8}$   
9. (i)  $\frac{3}{13}$    (ii)  $\frac{1}{2}$    (iii)  $\frac{10}{13}$    (iv)  $\frac{6}{13}$   
10. 12   11. (i)  $\frac{13}{46}$    (ii) 0   (iii)  $\frac{1}{46}$    12.  $\frac{157}{600}$    13. (i)  $\frac{1}{6}$    (ii)  $\frac{5}{6}$    (iii)  $\frac{5}{18}$   
14. (i)  $\frac{1}{8}$    (ii)  $\frac{3}{4}$    (iii)  $\frac{1}{8}$

## Exercise 8.4

1.  $\frac{11}{15}$    2. (i) 0.58   (ii) 0.52   (iii) 0.74   3. 0.1   4. 1.2   5. 0.2  
6.  $\frac{5}{9}$    7.  $\frac{1}{13}$    8.  $\frac{5}{6}$    9.  $\frac{7}{8}$    10.  $\frac{73}{280}$    11.  $\frac{17}{40}$    12. 1   13.  $\frac{11}{48}, \frac{11}{24}, \frac{11}{16}$    14.  $\frac{29}{35}$

## Exercise 8.5

1	2	3	4	5	6	7	8	9	10	11	12	13	14	15
(C)	(A)	(C)	(B)	(C)	(D)	(B)	(A)	(A)	(B)	(B)	(B)	(C)	(C)	(D)

## Unit exercise-8

1. 8,12   2. 5.55   3. 7   4. 81   5. 5.17, 1.53   6. City A   7. 60, 40  
8.  $\frac{1}{9}$    9.  $\frac{3}{4}$    10. 10   11.  $\frac{13}{20}$    12. (i)  $\frac{13}{49}$    (ii)  $\frac{3}{49}$    (iii)  $\frac{10}{49}$    (iv)  $\frac{1}{49}$

## MATHEMATICAL TERMS

Algorithm	படிமுறை	Decompose	பிரித்தல்
Alternate segment	ஒன்றுவிட்ட துண்டு	Diagonal matrix	மூலைவிட்ட அணி
Altitude	குத்துயரம்	Dimensions	பரிமாணங்கள்
Angle bisector	கோண இருசம வெட்டி	Discriminant	தன்மைக் காட்டி
Angle of depression	இறக்கக் கோணம்	Distributive property	பங்கீட்டுப் பண்பு
Angle of elevation	ஏற்றக் கோணம்	Domain	மதிப்பகம்
Arithmetic progression	கூட்டுத்தொடர் வரிசை	Equal matrices	சம அணிகள்
Arrow diagram	அம்புக்குறி படம்	Equiangular	சமகோணம்
Axis	அச்ச	Event	நிகழ்ச்சி
Axis of symmetry	சமச்சீர் அச்ச	Frustum	இடைக் கண்டம்
Basic proportionality	அடிப்படை விகித சமம்	Functions	சார்புகள்
Bijection	இருபுறச் சார்பு	Geometric progression	பெருக்குத்தொடர் வரிசை
Cartesian product	கார்டீசியன் பெருக்கல்	Geo-positioning system	புவி நிலைப்படுத்தல் அமைப்பு
Circular motion	வட்ட இயக்கம்	Graphical form	வரைபடமுறை
Clinometer	சாய்வுமானி	Great circle	மீப்பெரு வட்டம்
Co-domain	துணை மதிப்பகம்	Height and distance	உயரங்களும் தூரங்களும்
Coefficient of range	வீச்சுக் கெழு	Hemisphere	அரைக் கோளம்
Coefficient of variation	மாறுபாட்டுக் கெழு	Hollow	உள்ளீடற்ற
Collinearity	நேர்க் கோட்டமைவு	Horizontal level	கிடைமட்ட வரிசை
Column matrix	நிரல் அணி	Horizontal line test	கிடைமட்டக் கோட்டுச் சோதனை
Combined solids	இணைந்த திண்மங்கள்	Hyperbola	அதிபரவளையம்
Common difference	பொது வித்தியாசம்	Identity function	சமனிச் சார்பு
Common ratio	பொது விகிதம்	Image	நிழல் உரு
Completing square method	வர்க்கப் பூர்த்தி முறை	Inclination	சாய்வுக் கோணம்
Composition of functions	சார்புகளின் இணக்கம்	Inconsistent	ஒருங்கமைவற்ற
Concurrency theorem	ஒருங்கிசைவுத் தேற்றம்	Injection	ஒருபுறச் சார்பு
Concurrent	ஒருங்கிசையும்	Intercept	வெட்டுத்துண்டு
Concyclic	ஒரேபிரதியிலுள்ள	Into function	உள்நோக்கிய சார்பு
Congruence	ஒருங்கிசைவு	Kadhams (unit of distance)	காதங்கள் (தூரத்தின் அலகு)
Consistent	ஒருங்கமைவுடைய	Latitude	அட்சரேகை
Constant function	மாறிலிச் சார்பு	Lemma	துணைத் தேற்றம்
Coordinate axes	ஆயக்கூறு அச்ச	Line of sight	பார்வைக் கோடு
Counter-clock wise	வலமிருந்து இடம்	Linear equations	நேரிய சமன்பாடுகள்
Curved surface area	வளைபரப்பு	Linear function	நேரிய சார்பு

Longitude	தீர்க்கரேகை
Magnitude	அளவு
Many-one function	பலவற்றிற்கொன்றான சார்பு
Matrix	அணிகள்
Measures of central tendency	மைய நிலைப் போக்கு அளவைகள்
Measures of dispersion	சிதறல் அளவைகள்
Median	நடுக்கோடு
Modular	மட்டு
Mutually exclusive events	ஒன்றையொன்று விலக்கும் நிகழ்ச்சிகள்
Negative of a matrix	எதிர் அணி
Non-vertical lines	நேர்க் குத்தற்ற கோடுகள்
Non-zero integer	பூச்சியமற்ற முழு
Non-zero real number	பூச்சியமற்ற மெய் எண்
Null matrix / Zero matrix	பூச்சிய அணி
Null relation	சுழி தொடர்பு
Oblique cylinder	சாய்ந்த உருளை
Oblique frustum	சாய்ந்த இடைக் கண்டம்
One-one function	ஒன்றுக்கொன்றான சார்பு
Onto function	மேல் சார்பு
Ordered pair	வரிசைச் சோடிகள்
Outcomes	விளைவுகள்
Parabola	பரவளையம்
Parallel planes	இணை தளங்கள்
Perpendicular bisector	செங்குத்து சமவெட்டி
Point of contact	தொடுபுள்ளி
Point of intersection	வெட்டுப்புள்ளி
Pre-image	முன் உரு
Quadratic equation	இருபடிச் சமன்பாடுகள்
Quadratic function	இருபடிச் சார்பு
Quadratic polynomials	இருபடி பல்லுறுப்புக் கோவைகள்
Random experiment	சமவாய்ப்புச் சோதனை
Range	வீச்சகம் (அ) வீச்சு
Rational expression	விகிதமுறு கோவை
Real valued function	மெய்மதிப்புச் சார்பு
Reciprocal function	தலைகீழ்ச் சார்பு

Relations	தொடர்புகள்/ உறவுகள்
Revolutions	சுழற்சி
Right circular cone	நேர்வட்டக் கூம்பு
Right circular cylinder	நேர்வட்ட உருளை
Row matrix	நிரை அணி
Sample point	கூறுபுள்ளி
Sample space	கூறுவெளி
Scalar matrix	திசையிலி அணி
Secant	வெட்டுக்கோடு
Sequence	தொடர்வரிசை
Series	தொடர்
Similar triangle	வடிவொத்த முக்கோணம்
Simultaneous linear equations	ஒத்த நேரிய சமன்பாடுகள்
Slant height	சாயுயரம்
Slope or gradient	சாய்வு
Solid	திண்மம்
Square matrix	சதுர அணி
Standard deviation	திட்ட விலக்கம்
Surface area	புறப்பரப்பு
Table form	அட்டவணை முறை
Tangents	தொடுகோடுகள்
Theodolite	தளமட்டக் கோணமாணி
Tossed	சுண்டப்படுதல்
Total surface area	மொத்தப் பரப்பு
Transpose matrix	நிரை நிரல் மாற்று அணி
Trial	முயற்சி
Triangular matrix	முக்கோண அணி
Unbiased coins	சீரான நாணயங்கள்
Undefined	வரையறுக்கப்படாதது
Unique solution	ஒரேயொரு தீர்வு
Uniqueness	தனித் தன்மை
Unit matrix / Identity matrix	அலகு அணி
Variance	விலக்க வர்க்க சராசரி
Vertical angle	உச்சிக் கோணம்
Vertical line test	குத்துக்கோட்டுச் சோதனை
Zeros of polynomials	பல்லுறுப்புக் கோவையின் பூச்சியங்கள்

## Secondary Mathematics - Class 10

### Text Book Development Team

#### Reviewers

- **Dr. R. Ramanujam**  
Professor, Institute of Mathematical Sciences, Taramani, Chennai.
- **Dr. S. Kesavan**  
Institute of Mathematical Sciences, Chennai (Retd)  
Adjunct Professor, IIT, Madras.
- **Dr. A.M.S. Ramasamy**  
Professor of Mathematics  
VelTech Rangarajan Dr. Sagunthala R&D Institute  
of Science and Technology, Avadi, Chennai.
- **Mr. R. Athmaraman**  
Mathematics Educational Consultant  
Association of Mathematics Teachers of India, Chennai.

#### Domain Expert

- **Dr. R. Sivaraman**  
Associate professor, Department of Mathematics  
D.G. Vaishnav college, Arumbakkam, Chennai-106.

#### Academic Coordinator

- **B. Tamilselvi**  
Deputy Director, SCERT, Chennai.

#### Coordinator

- **R. Geetharani**  
B.T. Assistant, PUMS, Perundurai, Erode.

#### Content Readers

- **Dr. M.P. Jeyaraman**  
Assistant Professor of Mathematics  
L.N. Govt. College, Ponneri.
- **Dr. N. Geetha**  
Assistant Professor of Mathematics  
Quaid-e-Millath college, Chennai.
- **C. Shobana Sharma**  
Assistant professor of Mathematics  
Bharathi Womens College, Chennai.

#### ICT Coordinator

- **D. Vasu Raj**  
PGT & HOD (Maths)  
KRM Public School Chennai.

#### QR CODE MANAGEMENT TEAM

- **R. Jaganathan**, Secondary Grade Teacher,  
PUMS, Ganesapuram, Tiruvannamalai.
- **M. Murugesan**, B.T. Asst.,  
PUMS, Pethavelankottagam, Thiruvaur.
- **M. Saravanan**, B.T. Asst.,  
GGHHSS, Puthupalayam, Salem.

#### Content Writers

- **Dr. S. Muthukaruppan**  
Lecturer, DIET, Machvadi, Pudukkottai.
- **J. Johnson**  
Lecturer, DIET, Kalayarkoil, Sivagangai.
- **P. Viswanathan**  
B.T. Assistant, GHS, Thengiyatham, Kallakurichi.
- **K.S. Gandhimathi**  
B.T. Assistant, Chennai GHSS, Nungambakkam, Chennai.
- **P. Rishikesavan**  
B.T. Assistant, GHSS, Salaigramam, Sivagangai.
- **V. Arulmurugan**  
B.T. Assistant, GHS, Parivilagam, Cuddalore.
- **R.C. Dorairaj**  
B.T. Assistant, GHSS, Getticheviyur, Erode.
- **G. Jeyaraj**  
B.T. Assistant, GHSS, Avudaiyapuram, Virudhunagar.
- **G. Maria Lancy**  
B.T. Assistant Sishya school, Hosur, Krishnagiri.
- **M. Amal Raj**  
B.T. Assistant, P.M.H.S.S, Zamin Royapet, Chengalpet.

#### Art and Design Team

##### Layout Artist

- **Joy Graphics**, Chintadripet, Chennai - 02.

##### Inhouse-QC

- **Jerald Wilson, Rajesh Thangappan**
- **Mathan Raj, Adison Raj, Arun Kamaraj**
- **Yogesh, Sridhar Velu, Prasanth**

##### Cover Design

- **Kathir Arumugam**

##### Coordination

- **Ramesh Munisamy**

##### Typist

- **A. Palanivel**, Typist, SCERT, Chennai.

This book has been printed on 80 GSM  
Elegant Maplitho paper  
Printed by offset at :